

muratec™



***MFX-2030/MFX-1430
F-560/F-520***

Plain-paper digital Fax/Copier/Printer/Scanner

User Guide

muratec™
www.muratec.com

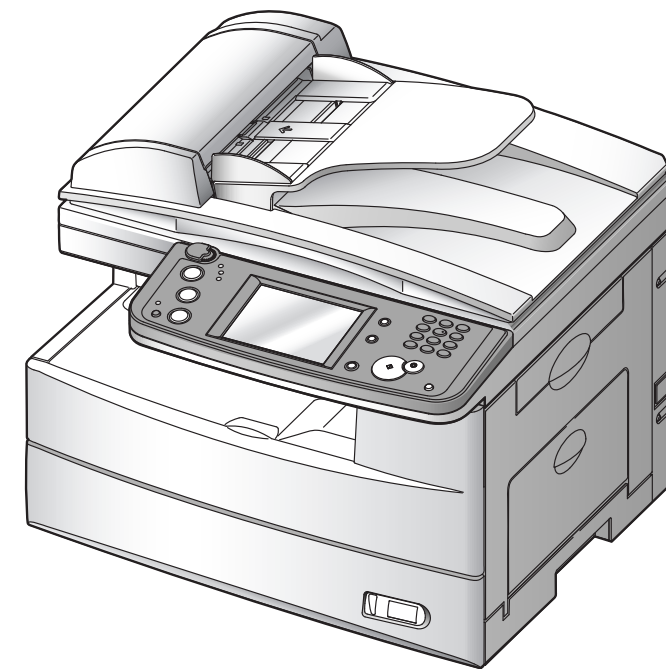

Muratec America, Inc.
3301 E, Plano Parkway, Suite 100
Plano, Texas 75074





As an **Energy Star**[®] partner, Muratec has determined that this product meets the Energy Star[®] guidelines for energy efficiency.



Super G3 is an extension of Group 3 fax technology standards, allowing the use of high-speed ITU-T V.34 modems for 33.6 Kbps transmission and high-speed protocols for rapid handshaking.

JBIG — Joint Bi-level Image experts Group, the new ITU-T standard image data compression method. As JBIG compresses the data more efficiently than MMR, it is especially effective when transmitting half-tone (grayscale) image document.



QuadAccess

QuadAccess is a more powerful version of what already is a pretty powerful feature, called dual access. While a fax with normal dual access allows you to do two things at once, QuadAccess allows you to do four operations at once. For example, even if the machine is (1) printing a copy, (2) transmitting from memory and (3) scanning documents for a different memory transmission, you can still (4) program the machine.

Trademarks

Muratec, the Muratec logo and all Muratec product names contained herein are trademarks of Murata machinery, Ltd and Muratec America, Inc.

QuadAccess is registered trademark of Muratec America Inc.

All other products referenced are registered trademarks or trademarks of their respective companies.

This manual and any updates to it can be found online at **www.muratec.com**

Go to the “Products” section of this site, then click on “MFX-2030” or “MFX-1430” or “F-560” or “F-520”.

Welcome

Thank you for choosing the Muratec MFX-2030/MFX-1430/F-560/F-520.

This User Manual describes the functions, operating procedures, precautions, and basic troubleshooting for the Muratec MFX-2030/MFX-1430/F-560/F-520.

Before using this machine, be sure to read the User Manual thoroughly in order to ensure that you use the machine efficiently. After you have gone through the manual, keep it handy at all times.

Note that some of the illustrations of the machine used in the User Manual may be different from what you actually see on your machine.

The Manual

There are five manuals for this machine. The description for each manual is as follows:

Quick Reference Guide

Explains most frequently used functions and how to clean paper jams.

User Guide

Explains all the functions of your machine and the information of maintenance.

Network Guide

Explains about network settings.

Local Printer and Scanner Manual [CD]

Explains how to install the drivers and the information of print driver properties etc.

Network Printer Manual [CD]

Explains how to install the driver and how to use the PC-Fax function.

[CD]: Located on the driver CD

Getting Started

Using the Address Book

Faxing

Internet Fax functions

Scanning

Reviewing or canceling commands

Copying

PC Fax functions

PC Printing

Special features

Restricting use of the machine

Machine Settings

Report & Lists

Maintenance & Troubleshooting

Appendix & Index

1

2

3

4

5

6

7

8

9

10

11

12

13

14

AI

Contents

Regulatory information	I-1
United States of America	I-1
Canada	I-2
Limited warranty	I-3
Precautions	I-5
Installation precautions	I-5
Power requirements	I-6
Space requirements	I-7
General precautions	I-7
Storing and handling the toner and drum cartridges	I-8
Legal restrictions on copying	I-9
Caution labels	I-10
Symbols and terms	I-11
Main Features	I-12
Copy	I-12
Copy/Fax	I-12
Copy/Fax/Scan	I-13
Fax	I-14
Mail	I-15
Fax/Mail	I-15
Scan	I-16
General	I-17
Chapter 1	
Getting Started	1-1
Machine overview	1-2
Machine layout	1-2
Control panel overview	1-3
Operating tips	1-4
Changing modes	1-4
Operating the display	1-4
Display description	1-4
Key displays and functions	1-9
Entering characters	1-10
Memory back-up	1-13
Initial setup	1-14
Clearing stored settings	1-14
Getting started	1-15
Specifying the initial settings	1-16
Using the Energy save mode	1-23
Document and paper handling	1-24
Document handling	1-24
Paper handling	1-26
Chapter 2	
Using the Address Book	2-1
The address book	2-2
The address book display	2-2
Special dialing characters	2-3
Registering destinations in Address Book	2-4
Registering or editing a destination	2-4
Alternative 1: Registering or editing directly into the address book	2-7
Alternative 2: Registering or editing the fax number using the numeric keys	2-8
Alternative 3: Registering an e-mail address using the QWERTY keypad	2-9
Deleting a destination	2-10

Alternative: Deleting directly from the address book.....	2-11
How to dial using the address book.....	2-12
Call group dialing.....	2-14
Registering or editing a call group	2-14
Deleting a call group	2-15
How to dial using a call group	2-16
Making a phone call	2-19
How to dial using the address book.....	2-19
If the call fails.....	2-20
How to receive a phone call.....	2-20
Adjusting the optional handset volume.....	2-20
Adjusting the speaker volume	2-21

Chapter 3

Faxing.....	3-1
Before sending	3-2
Document handling	3-2
Scanning resolution.....	3-2
Scanning contrast.....	3-3
Sending method	3-3
Memory overflow message	3-4
Sending a fax	3-5
Memory transmission.....	3-5
Real-time transmission (non-memory transmission)	3-8
Manual transmission (non-memory transmission).....	3-9
Changing Document Scan in Mid Scan (Mixed Transmission).....	3-10
Redialing.....	3-13
Automatic fax redialing.....	3-13
Manual redialing	3-13
Receiving a fax.....	3-15
Selecting the reception mode	3-15
Manual reception mode	3-15
Automatic reception mode.....	3-16
Answering calls manually.....	3-17
If paper runs out during fax reception	3-17
Settings for fax reception	3-20
Setting the number of rings	3-20
Print settings	3-20
Advanced fax functions	3-23
Broadcasting	3-24
Fax & Copy.....	3-28
Sending faxes with TTI information attached	3-30
Cover page.....	3-32
Delayed transmission.....	3-34
Batch transmission.....	3-35
Specifying the document scanning size	3-41
Polling transmission	3-42
Overseas transmission	3-43
Using an alternative telephone network service provider (Dial prefix)	3-44
Block junk fax	3-46
Polling reception	3-50
Fax forwarding.....	3-51
Separator page.....	3-57

Chapter 4

Internet Fax functions	4-1
Before sending	4-2
Sending an e-mail.....	4-2

Entering an e-mail address using the QWERTY keypad.....	4-2
Re-mail	4-3
Mail History	4-4
Reviewing or canceling commands	4-6
Advanced mail functions.....	4-6
Adding a text message to your e-mail	4-7
Batch scanning	4-11
Checking for new e-mail.....	4-12
Specifying the attachment file format	4-13

Chapter 5

Scanning.....	5-1
Before scanning	5-2
Resolution	5-2
Contrast	5-3
Document type	5-4
Scan size.....	5-5
Entering the file name.....	5-6
Scan to e-mail	5-9
Sending a document by e-mail.....	5-9
Selecting a destination from the Address Book	5-11
Searching for an e-mail address	5-15
Sending a document using the mail history.....	5-21
Re-mail	5-22
Reviewing or changing your selected destinations	5-23
Adding a text message to your e-mail	5-24
Scan to folder	5-28
Scanning documents into a folder.....	5-28
Scanning documents using a folder shortcut	5-33
Reviewing or canceling selected folders	5-34
Registering or editing a folder shortcut	5-35
Scan to FTP	5-42
Scanning documents to an FTP server.....	5-42
Registering an FTP server to a shortcut	5-45
Scanning documents using an FTP shortcut	5-47
Reviewing or canceling selected FTP servers	5-48
Registering or editing an FTP server shortcut	5-49
Advanced functions	5-56
Color	5-56
Zoom	5-57
Batch scanning	5-59
Selecting the file format	5-60
Duplex scanning	5-61
Broadcasting	5-63
Attaching additional files to the scanned document.....	5-64

Chapter 6

Reviewing or canceling commands.....	6-1
Reviewing or canceling commands	6-2
To review or cancel a command	6-2
Reviewing or canceling parts of a broadcast	6-4
Printing a delayed command list.....	6-6
Printing a stored document.....	6-6
View or print the results of a fax transaction	6-8

Chapter 7

Copying.....	7-1
Before copying	7-2

Document and paper handling	7-2
Memory overflow message	7-2
Making copies	7-3
Making copies	7-3
Setting the next document	7-3
Copying using both document glass and ADF	7-5
Copy reservation	7-7
Basic copy settings	7-8
Document type	7-8
Contrast	7-9
Number of copies	7-9
Advanced copy functions	7-10
Selecting the paper size	7-11
Zoom ratio	7-12
Automatic sorting	7-13
Combine	7-14
Duplex copy	7-16
Card Copy	7-25
Specifying the document size to copy	7-27
Checking the copy print queue	7-28
Chapter 8	
PC-Fax function	8-1
Installing the driver	8-2
Sending a PC fax	8-3
Chapter 9	
PC printing	9-1
Installing the driver	9-2
Printing a document from the PC	9-3
Chapter 10	
Special features	10-1
Soft keys	10-2
Soft key functions	10-2
Programming a soft key	10-5
Macro keys	10-7
Registering or editing a Macro	10-7
Deleting a Macro key	10-10
Changing the Macro key speed	10-11
Editing macro key titles	10-12
Executing a Macro command	10-13
Program one-touch	10-14
Registering or editing a program one-touch	10-14
Deleting a program one-touch	10-19
How to use a program one-touch	10-20
F-code box feature	10-21
F-code introduction	10-21
Registering or editing an F-code box	10-21
Printing a list of F-code boxes	10-30
Printing a list of documents stored in F-code boxes	10-30
Deleting an empty F-code box	10-30
Storing a document in a bulletin box	10-31
Printing stored documents	10-33
Deleting stored documents	10-35
Sending a document using a subaddress and password	10-37
Polling a document using a subaddress and password	10-38
Viewing the page counters	10-39

Checking the number of printed pages	10-39
Chapter 11	
Restricting use of the machine	11-1
Security features	11-2
Passcode protection	11-2
Security reception	11-3
PIN masking	11-7
Department management	11-13
Registering the copy charge (Cost management)	11-13
Registering department codes	11-14
Deleting department codes	11-16
Turning department management On	11-17
Using department codes	11-17
Printing a list of department management settings	11-19
Resetting the department counter	11-20
Turning department management protection On/Off	11-21
Copy protection	11-22
Chapter 12	
Machine Settings	12-1
Machine setting menu	12-2
Copy settings	12-3
Accessing the copy settings	12-3
Fax settings	12-4
Accessing the default fax settings	12-4
Accessing other fax settings	12-5
Scanner settings	12-7
Accessing the default scan settings	12-7
Accessing other scan settings	12-8
Mail settings	12-9
Accessing the mail settings	12-9
Management settings	12-11
Accessing the management settings	12-11
Paper settings	12-14
Accessing the paper settings	12-14
Chapter 13	
Report & Lists	13-1
Lists and journal reports	13-2
Activity journal	13-5
Setting the activity journal	13-5
Printing the activity journal manually	13-6
Setting the order on the activity journal	13-7
Transmission confirmation report	13-8
Setting the transmission confirmation report	13-8
Stored document list	13-9
Erased document notification	13-10
Chapter 14	
Maintenance & Troubleshooting	14-1
Maintenance	14-2
Cleaning tips	14-2
Cleaning the scanning area	14-2
Cleaning the ADF rollers	14-3
Cleaning the drum charge wire and the print head	14-3
Replacing the toner cartridge	14-5

Replacing the drum cartridge	14-7
Troubleshooting	14-9
Document jams	14-9
Paper jams	14-13
Displayed error messages	14-16
“Check Message” printouts	14-23
Error codes	14-24
Machine errors	14-26
Faxing errors	14-26
Scanning errors	14-27
Copying errors	14-28
PC printing errors	14-28
Local Scanner errors	14-29
Print quality problems	14-30
If you cannot solve the problem	14-32
Appendix & Index.....	AI-1
Specifications	AI-2
General	AI-2
Fax	AI-3
Copy	AI-3
Printer	AI-3
Scanner	AI-4
Consumable items	AI-4
Index	AI-5

Regulatory information

Customer information

United States of America

This equipment complies with Part 68 of FCC rules and the requirements adopted by the ACTA. On the rear panel of this equipment is a label that contains, among other information, a product identifier in the format US:DKUFA02B002C (for F-560/F-520) or US:DKUFA02B003C (for MFX-2030/MFX-1430). If required, this number must be provided to the telephone company.

The REN is used to determine the number of devices that may be connected to a telephone line. Excessive RENs on a telephone line may result in the devices not ringing in response to an incoming call. In most but not all areas, the sum of RENs should not exceed five (5.0). To be certain of the number of devices that may be connected to a line, as determined by the total RENs, contact the local telephone company. The REN for this product is part of the product identifier that has the format US:DKUFA02B002C (for F-560/F-520) or US:DKUFA02B003C (for MFX-2030/MFX-1430). The digits represented by 02B are the REN without a decimal point.

Your fax is designed for use on standard-device telephone lines. The fax connects to the telephone line with a standard line called the USOC RJ-11C.

A plug and jack used to connect this equipment to the premises wiring and telephone network must comply with the applicable FCC Part 68 rules and requirements adopted by the ACTA. A compliant telephone cord and modular plug is provided with this product. It is designed to be connected to a compatible modular jack that is also compliant. See installation instructions for details.

If the equipment MFX-2030/MFX-1430/F-560/F-520 causes harm to the telephone network, the telephone company will notify you in advance that temporary discontinuance of service may be required. But if advance notice isn't practical, the telephone company will notify the customer as soon as possible. Also, you will be advised of your right to file a complaint with the FCC if you believe it is necessary.

The telephone company may make changes in its facilities, equipment, operations or procedures that could affect the operation of the equipment. If this happens the telephone company will provide advance notice in order for you to make necessary modifications to maintain uninterrupted service.

If trouble is experienced with the equipment MFX-2030/MFX-1430/F-560/F-520, see operating instructions for details. For further repair or warranty information, please contact Muratec Customer Support Center at 800-347-3296 (from the U.S. only). If the equipment is causing harm to the telephone network, the telephone company may request that you disconnect the equipment until the problem is resolved.

Connection to party line service is subject to state tariffs. Contact the state public utility commission, public service commission or corporation commission for information.

If your home has specially wired alarm equipment connected to the telephone line, ensure the installation of the MFX-2030/MFX-1430/F-560/F-520 does not disable your alarm equipment. If you have questions about what will disable alarm equipment, consult your telephone company or a qualified installer.

This equipment is hearing aid compatible.

When programming emergency numbers and/or making test calls to emergency numbers:

- 1) Remain on the line and briefly explain to the dispatcher the reason for the call.
- 2) Perform such activities in the off-peak hours, such as early morning or late evenings.

To protect your product against power surges, we recommend the use of a power protection device (Surge arrester).

The Telephone Consumer Protection Act of 1991 makes it unlawful for any person to use a computer or other electronic device, including FAX machines, to send any message unless such message clearly contains in a margin at the top or bottom of each transmitted page or on the first page of the transmission, the date and time it is sent and an identification of the business or other entity, or other individual sending the message and the telephone number of the sending machine or such business, other entity, or individual. (The telephone number provided may not be a 900 number or any other number for which charges exceed local or long-distance transmission charges.)

For instructions on programming this information into your FAX machine, see "Initial setup" on pages 1-14 to 1-22 of this manual.

FCC Part 15

This equipment has been tested and found to comply with the limits for a Class A digital devices, pursuant to Part 15 of the FCC Rules. These limits are designed to provide reasonable protection against harmful interference when the equipment is operated in a commercial environment. This equipment generates, uses, and can radiate radio frequency energy and, if not installed and used in accordance with the instruction manual, may cause harmful interference to radio communications. Operation of this equipment in a residential area is likely to cause harmful interference in which case the user will be required to correct the interference at his own expense.

Canada

NOTICE:

This equipment meets the applicable Industry Canada Terminal Equipment Technical Specifications.

NOTICE:

The Ringer Equivalence Number (REN) for this terminal equipment is 0.2. The REN assigned to each terminal equipment provides an indication of the maximum number of terminals allowed to be connected to a telephone interface. The termination on an interface may consist of any combination of devices subject only to the requirement that the sum of the Ringer Equivalence Numbers of all the devices does not exceed five.

Canadian ICES-003

This Class A digital apparatus complies with Canadian ICES-003.

Cet appareil numérique de la classe A est conforme à la norme NMB-003 du Canada.

Limited warranty

This warranty is made by Muratec America, Inc. (hereafter referred to as “Muratec”). This warranty is valid only on Muratec products purchased and used in the United States of America. This warranty applies to the product only while owned and used by the original purchaser (“Customer”). If ownership of the product is transferred, this warranty terminates. This warranty does not apply to any product in use for rental purposes.

This Muratec product is warranted against defects in material and workmanship for ninety (90) days commencing the date of original Customer purchase. If the product is defective in material and/or workmanship (normal wear and tear excepted) during the warranty period, Muratec or its authorized representative will, during Muratec’s established service availability hours, make necessary adjustments and repairs, including, at Muratec’s option, installation of replacement parts. Muratec’s service availability hours are 8:30 am to 5:00 pm (Central time) Monday through Friday, excluding Muratec-recognized holidays. Muratec will complete the necessary adjustments and repairs within a reasonable time period, as dictated by the nature of the problem and by Muratec’s service schedule. Replacement parts may have been used and/or reconditioned. Parts that have been replaced will remain the property of Muratec. This warranty is subject to the obligations and exclusions set forth.

Obligations

1. This warranty will be honored only on presentation of the original dated authorized Muratec bill of sale or Muratec dealer bill of sale or sales slip to an authorized Muratec service representative or service center. For the name of your authorized service center, contact Muratec (from the United States, call 1-469-429-3350; from Canada, check your in-box materials for the number to call).
2. During the warranty period, the Customer must notify Muratec by telephone of any defective product material and/or workmanship.
3. Transportation (including prepayment of freight and insurance charges) of the product to and from an authorized service center, designated by Muratec, is the responsibility of the Customer.
4. If Muratec provides maintenance or responds to a call which is outside the scope of this warranty, such maintenance shall be billed to the Customer at Muratec’s then-current rates for maintenance and parts and shall be due and payable in full upon receipt of invoice.

Exclusions

1. This warranty shall not cover a product with missing or altered original identification marks.
2. This warranty applies only to products that the purchaser has properly installed, adjusted and operated in accordance with the instructions set forth in or provided with product literature. This warranty does not apply to any product which has been subjected to tampering, alteration, misuse, abuse, neglect, improper installation or transportation damage. Nor does it apply to costs for any service requested for demonstration or to confirm proper operation of this product.
3. The warranty shall not apply to adjustments, repairs or replacements necessitated by any cause beyond the control of Muratec (whether foreseeable or not) including, but not limited to, any malfunction, defects or failure caused by or resulting from any of the following: improper unpacking or installation, unauthorized service or parts, or improper maintenance or cleaning, modification or repair by the Customer, accident (including, without limitation, unavoidable accidents), fire, flood or other Acts of God, improper telephone or electrical power or surges thereof, interconnection with or use of non-compatible equipment or supplies (including paper), or placement of the product in an area which does not conform to Muratec space, electrical and/or environmental requirements.

4. Muratec will not be required to make adjustments, repairs or replacements if the product is installed or used at a location deemed by Muratec to be hazardous to health or safety, or if Muratec is not provided with free and reasonable access to the product and a telephone during service availability hours, or if the product location is not accessible by an authorized Muratec service vehicle.

EXCEPT AS EXPRESSLY SET FORTH ABOVE, AND EXCEPT TO THE EXTENT PROHIBITED BY APPLICABLE LAW, MURATEC MAKES NO OTHER WARRANTIES, EXPRESS OR IMPLIED (INCLUDING, BUT NOT LIMITED TO, ANY IMPLIED WARRANTIES OF MERCHANTABILITY OR FITNESS FOR A PARTICULAR PURPOSE, AND ANY WARRANTY ARISING FROM COURSE OF DEALING OR USAGE OF TRADE), AND MURATEC EXPRESSLY DISCLAIMS ALL WARRANTIES NOT STATED HEREIN. IN THE EVENT THE PRODUCT IS NOT FREE FROM DEFECTS AS WARRANTED ABOVE, THE CUSTOMER'S SOLE REMEDY SHALL BE REPAIR OR REPLACEMENT AS PROVIDED ABOVE. UNDER NO CIRCUMSTANCES SHALL MURATEC BE LIABLE TO THE CUSTOMER, OR TO ANY USER, FOR ANY DAMAGES, INCLUDING ANY INCIDENTAL OR CONSEQUENTIAL DAMAGES, EXPENSES, LOST PROFITS, LOST SAVINGS OR ANY OTHER DAMAGES ARISING OUT OF THE USE OR INABILITY TO USE THE MURATEC PRODUCT, EVEN IF MURATEC OR ITS REPRESENTATIVES HAVE BEEN ADVISED OF THE POSSIBILITY OF SUCH DAMAGES.

Some States do not allow the exclusion or limitation of incidental or consequential damages, and some States do not allow limitations on how long an implied warranty lasts, so the above limitations or exclusions may not apply to you. This warranty gives you specific legal rights, and you may also have other rights which vary from State to State.

Precautions

Installation precautions

Keep you machine clean

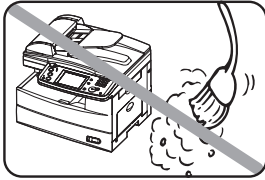

Dust buildup can damage your machine. However, do not use a dust cover, which can cause overheating.

Periodically clean your machine as instructed in this manual.

Keep your machine away from direct sunlight

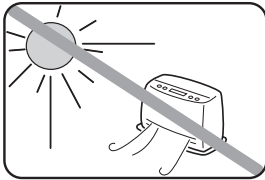

To avoid overheating, set up the machine away from direct sunlight or heating unit.

Keep your machine level and vibration-free

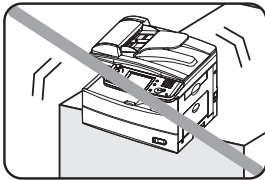

To avoid damage to the machine or personal injury, set the machine up in a level, vibration-free location.

Keep your machine near a phone jack & an AC power outlet

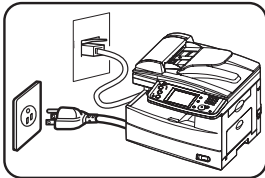

Your machine uses a standard (modular) telephone jack.

The power cord is about 6.5 feet long when stretched to its limit, and the power cord should never be stretched to its limit.

Keep your machine away from televisions and radios

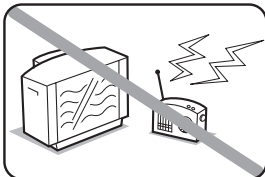

Many appliances and office equipment, including televisions, radios, copy machines, air conditioners and computers generate electronic noise that can interfere with the operation of your machine.

Avoid extreme high / low temperatures

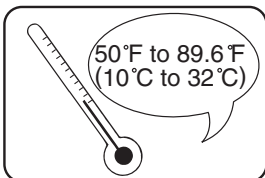

Use your machine within the temperature range of 10 °C to 32 °C (50 °F to 89.6 °F).

Power requirements

Use a standard AC 120 V outlet

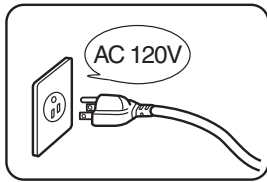

Use a standard three-pronged 120 V electrical outlet to power your machine. Using any other electrical outlet could damage your machine.

Do not share an extension cord connector with other plugs

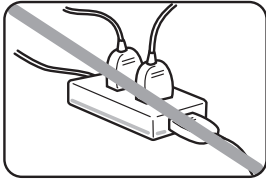

This could cause electrical shock.

Do not share an outlet with a large appliance

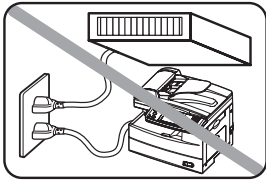

High-consumption appliances such as refrigerators and air conditioners can cause “draw-downs” which could damage your machine.

Plug in the power cord

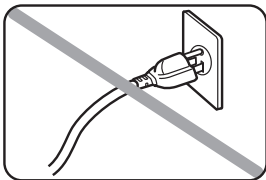

Plug the power cord carefully and completely into a wall outlet. Do not leave any portion of the electrical cord's metal plugs exposed. Doing so could cause a fire and increases the risk of electrical shock.

Make sure the outlet is not controlled by a wall switch

If it is, you will risk occasional shutoffs to the machine, causing you to lose fax message.

Use an electrical surge suppressor, preferably one which guards both telephone and electrical lines. This device helps to shield your machine from damaging high-voltage electrical surges.

Space requirements

To ensure proper ventilation and easy operation, set up the machine in an area that meets the minimum requirements for clearance as illustrated below.

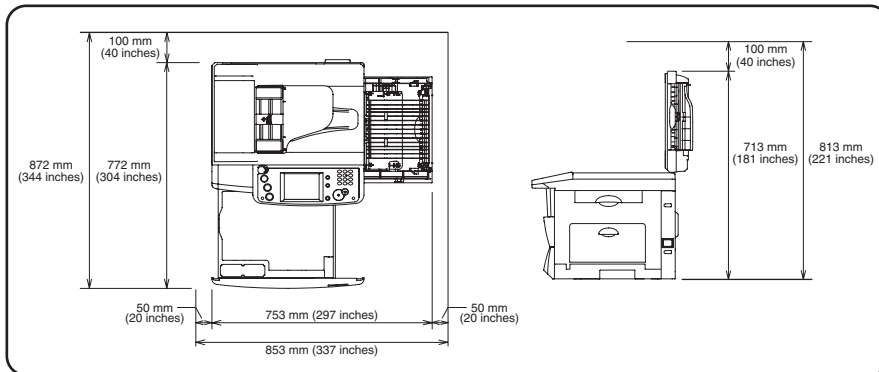

NOTE: In order to enable easy machine maintenance and replacement of consumables, maintain an adequate amount of space around the machine.

When lifting the machine, be sure to grab the handles on the left and right sides of the cassette tray.

General precautions

Never disassemble your machine

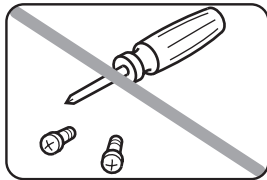

Disassembling your machine can cause serious injury to you and damage to your machine. If service is required, contact your Muratec dealer.

Never handle your machine or power cord with wet hands

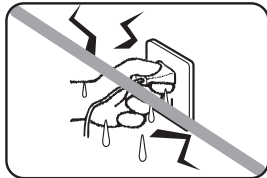

Never touch your machine or power cord if your hands are wet.

During electrical storms, disconnect the plug from the outlet

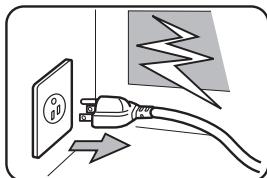

Electrical storms can cause electrical shock or damage to the machine.

Keep your machine dry and away from liquids

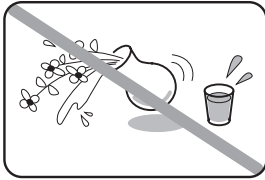

Keep liquids and metal pins or other objects away from your machine. If something falls into the machine, immediately turn OFF the power switch, unplug the power cord from the power outlet, and then contact your Muratec dealer.

Do not rest furniture or other equipment on the power cord

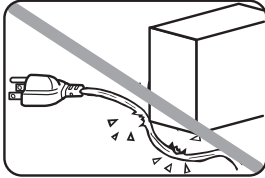

Do not put anything on or over the electrical power cord, and do not route the power cord under rugs or carpets. Doing so can damage the power cord and/or the machine, causing fire or electrical shock.

Allow clearance around the outlet

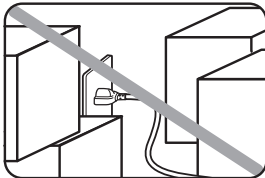

Do not stack boxes or furniture around the outlet.

Be careful not to damage the display

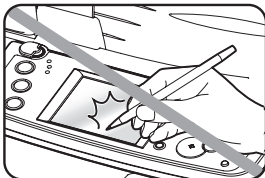

Never push down on the display with force, and never use a hard or pointed object to make a selection in the display.

Transporting the Machine

If you need to transport the machine over a long distance, consult your Muratec dealer.

Storing and handling the toner and drum cartridges

To avoid damage to your machine and to assure the best performance possible, follow these guidelines when storing and handling the toner and drum cartridges:

Use supplies manufactured specifically for Muratec machines

Using toner and drum cartridges or other supplies that are not manufactured specifically for your machine may affect the operation of your machine.

Storing the cartridges

Store the cartridges in a location that meets the following requirements:

- Free from direct sunlight
- Away from dusty conditions
- Away from floppy disks or other computer media, computer displays, or other materials sensitive to magnetic fields.
- Away from high humidity
- Do not stand the cartridge on its end and do not store it upside down.
- Do not open the protective bag containing the cartridge until you are ready to install the cartridge.

Cartridge handling

- **Do not burn toner cartridges**

Toner powder is extremely flammable. Exposure to flame can cause the toner cartridge to burn or explode, causing serious injury.

- Keep cartridges away from water and oil.
- Do not expose cartridges to direct sunlight.
- Do not subject cartridges to static or electrical shock.

⚠CAUTION: Be careful not to get the toner powder in your eyes. If toner powder gets in your eyes, immediately flush your eyes with water and seek medical assistance.

Legal restrictions on copying

Certain types of documents cannot be duplicated with the intent to pass copies of such documents off as the originals.

The following is not a complete list, but is meant to be used as a guide to responsible copying.

Financial instruments

- Personal checks
- Travelers checks
- Money orders
- Certificates of deposit
- Bonds or other certificates of indebtedness
- Stock certificates

Legal documents

- Food stamps
- Postage stamps (canceled or uncanceled)
- Checks or drafts drawn by government agencies
- Internal revenue stamps (canceled or uncanceled)
- Passports
- Immigration papers
- Motor vehicle licenses and titles
- House and property titles and deeds

General

- Identification cards, badges, or insignias
- Copyrighted works without permission of the copyright owner

In addition, it is prohibited under any circumstances to copy domestic or foreign currencies, or works of art, without permission of the copyright owner.

If you are unsure about the legal restrictions regarding the duplication of a document, consult with legal counsel.

Caution labels

The caution labels are attached to the machine as shown below, to avoid any serious injury.

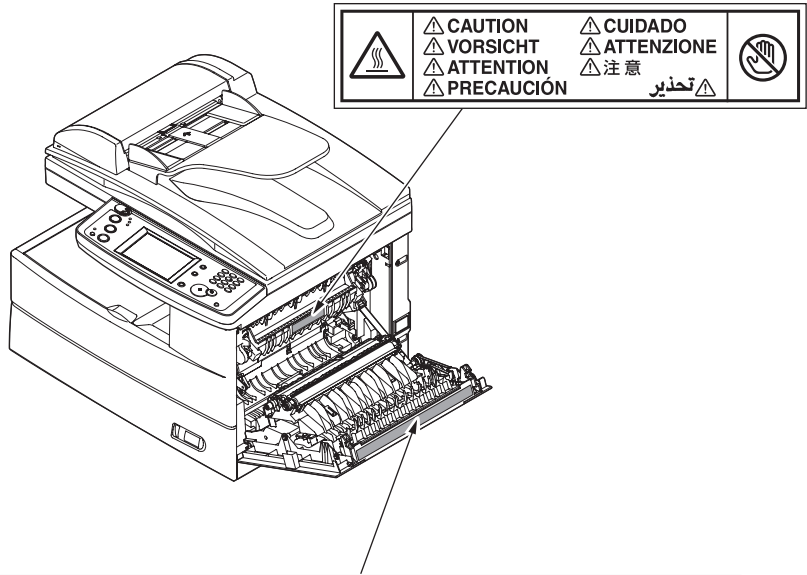

	CAUTION Hot area Do not touch	VORSICHT Heißer Bereich Nicht berühren	ATTENTION Partie chaude Ne touchez pas	PRECAUCIÓN Zona caliente No tocar	CUIDADO Área quente Não toque	ATTENZIONE Parte calda Non toccare	注意 高温! 禁止觸摸	تحذير حرارة عالية! لا تلمس
--	--	---	---	--	--	---	--------------------------	---

Symbols and terms

In this manual, the following symbols, terms and abbreviations are used. Please familiarize yourself with them.

⚠WARNING This symbol indicates how to avoid serious or potentially fatal injuries.

⚠CAUTION This symbol indicates how to avoid personal injury.

IMPORTANT: This instruction describes conditions or incorrect operations that could cause damage to your machine.

NOTE: A note describes helpful hints, restrictions and how to avoid problems.

[] The names of the keys on the control panel.

“ ” Items that appear on the display.





Document Original sheet(s) of paper you send, copy and scan on your machine.

Paper Paper to be printed on.

Tx Denotes sending.

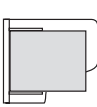
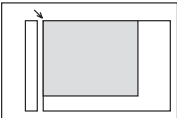
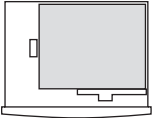
Rx Denotes receiving.

 Shows the direction of the document and paper.

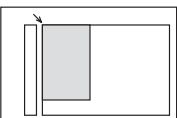
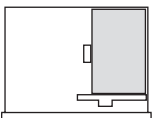
Direction mark	Document placed on the ADF or document glass*		Paper loaded in the paper cassette
 or Nothing Ex.) Letter			
 Ex.) Half-letter 			

* The document glass is available only for MFX-2030/MFX-1430 model.

Main Features

Copy

Card Copy (MFX-2030/1430 only) (see page 7-25)

Need to copy both sides of an id card, driver's license or check? Use the Card Copy mode to quickly capture card or check-size images onto a single sheet.

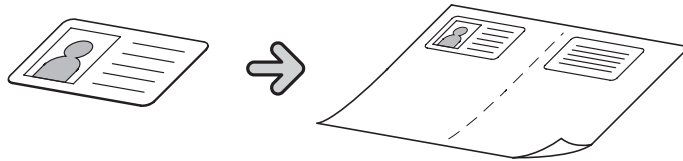

Combine Copy (See page 7-14)

Up to four separate images can be combined onto a single document, reducing paper consumption and consumable usage.



Copy/Fax

Macro Program (See page 10-7)

Programming copy jobs can be tedious, especially when you want to customize a job requiring several steps. If you regularly perform a job that requires multiple steps you can consolidate these steps into a macro, simplifying the process into a one-touch operation.

Department Codes (See page 11-13)

You can easily track machine usage and restrict machine access by activating the department code feature. Once activated, the machine will ask for a valid department code prior to access. A monetary cost can also be assigned to each job, making interoffice billing a snap.

Duplex Printing (See page 7-16)

Quickly convert one-sided originals into two-sided output by utilizing duplex printing. For additional paper and cost savings receive your incoming faxes as two-sided printouts.

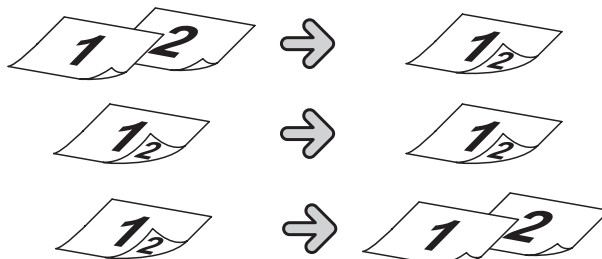

* For duplex printing with F-520/MFX-1430, the optional duplex printing unit is required.

Copy/Fax/Scan

Soft Keys (See page 10-2)

Soft keys allow one-touch access to important machine features. The keys on the default display are customizable, meaning you can set the features you use frequently onto the default display for easy access.

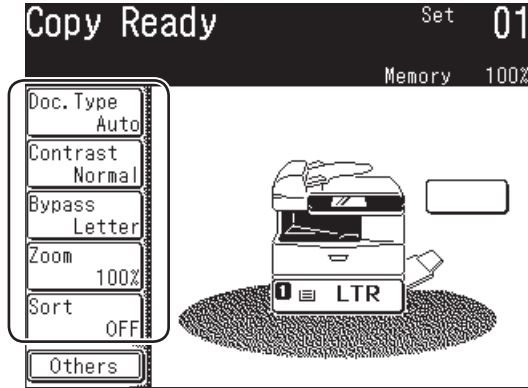

* This is the screen shown in the F-560/F-520 model.

Energy Save Mode (See page 1-23)

Energy Save mode assists in reducing energy consumption and total operating costs. If the machine is left idle for a "user-determined" amount of time, the machine will automatically enter energy save mode.

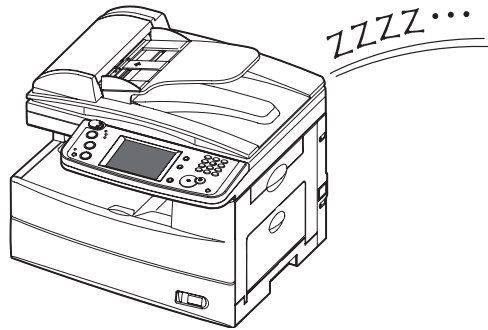

80 sheet ADF

While it's true most fax, copy and scan jobs contain less than 10 pages, you may have the occasional need to perform larger jobs. With the standard 80-sheet ADF large jobs do not have to be broken up, thus increasing efficiency.

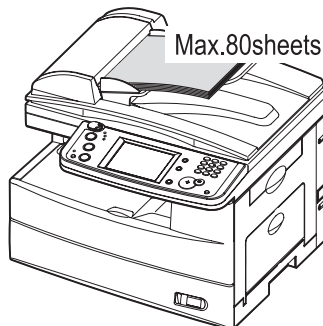

Fax

Dual Line Option

High-volume fax users will appreciate the ability to send and receive fax documents at the same time, greatly increasing office efficiency.

Security Reception (See page 11-3)

Security reception allows you to receive documents into password protected storage boxes. This insures that documents are only viewed by authorized personnel.

Batch Transmission (See page 3-35)

Scan documents into batch transmission storage boxes and schedule the transmission time for off-peak hours, both reducing operating costs and allowing the machine to be available during peak business hours.

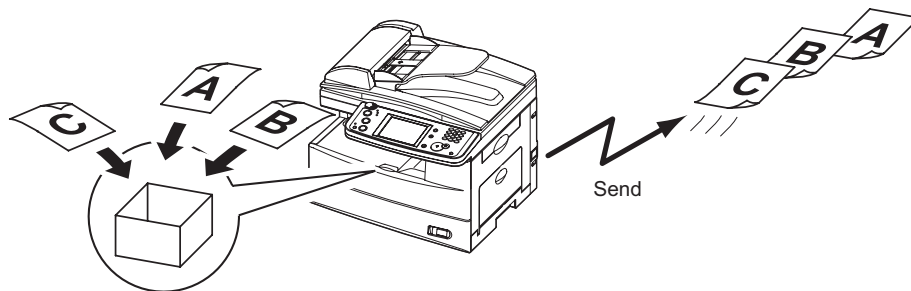

Fax Forwarding

Skipping town? Simply turn on the fax forwarding feature and have all inbound documents routed to a remote fax number. (See page 3-51.) Using a web browser, you can set up an advanced forwarding system. (See page 5-17 of the “Network guide”.)

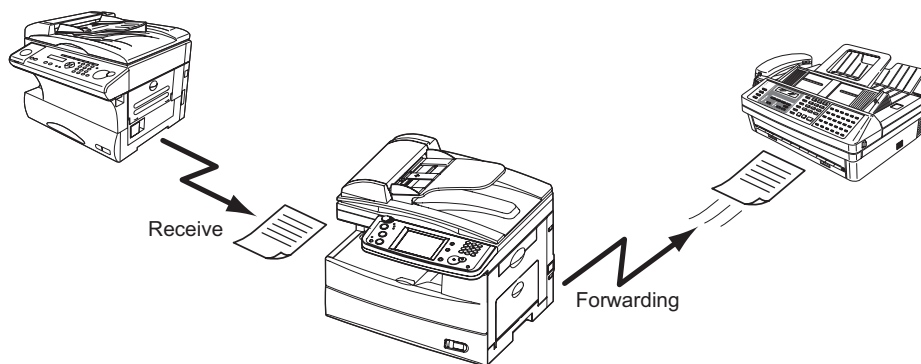

Transmission Confirmation Report (See page 13-8)

Automatically generate a transmission confirmation report to confirm whether or not your fax document reached the remote machine successfully.

PC-Faxing (See page 8-1)

Why move if you don't have to? Use the PC fax application to quickly send documents from your desktop to remote fax machines. The intuitive address book is easy to navigate to find a destination.

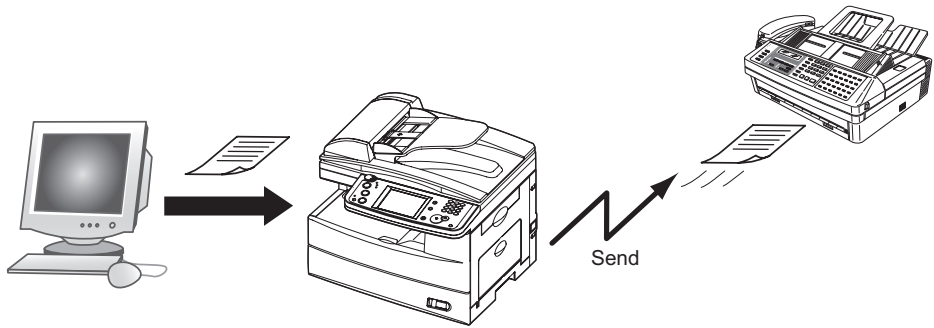

Mail

MDN/DSN Reporting (See "Network Guide")

When sending e-mail you may request a delivery status notification (DSN) which confirms whether the mail was received and/or a message disposition notification (MDN) which confirms whether the mail was read.

Fax/Mail

Address Book (See page 2-1)

Store important contact information into your machines address book for one-touch recall. Each contact can have a fax number, e-mail address and group(s) associated with them.

Mixed Broadcasting (See page 3-24)

Your machine can quickly send to both e-mail and fax destinations at the same time, eliminating the need to manually send each document.

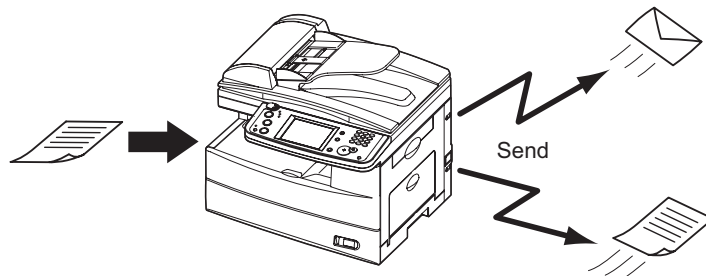

Directory Searching (LDAP) (See page 5-17)

Finding important contacts has never been easier. Press the [Search] on the display to quickly locate contacts, whether they reside in the machine-side address book or on a shared company directory.

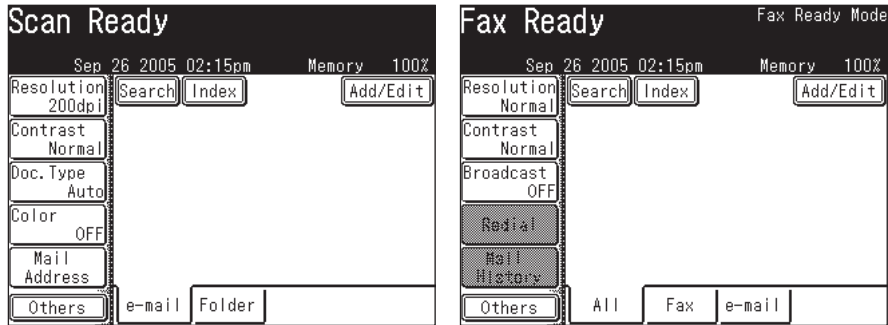

Personal/Shared Directories

With the OfficeBridge expansion kit installed you can keep personal contacts separate from the general directory. This allows for quick, secure access to your private contact list.

Scan

Network Scanning (See page 5-1)

Your machine can seamlessly convert hardcopy monochrome and color documents into digital files for storage and distribution. A feature unique to your machine is the ability to browse your internal network and seamlessly deliver documents directly into folder locations.

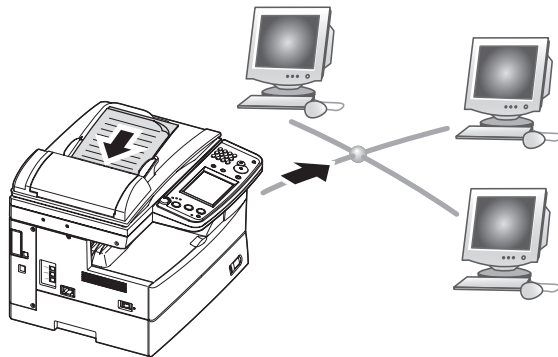

File Name and Format (See page 4-13, 5-6, 5-60)

Changing the file name and format when scanning has never been easier. You can name each file prior to scanning using an intuitive QWERTY keypad, making file retrieval easy. You may also change the file format (TIFF/PDF/JPEG) in the scan menu, insuring that each scan meets your archiving/retrieval requirements.

General

Network Printing (See page 9-1)

You're not training for the Olympics, so why run a marathon every time you need to make a copy? The convenient network printing function is standard and allows you to decentralize printing from the copy room to your small workgroup.

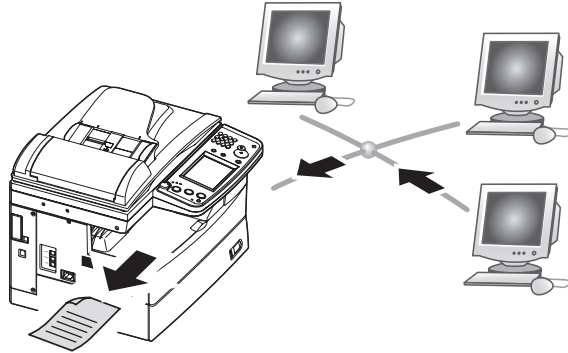

Local Printing/Scanning (See page 9-1)

Your machine's small footprint is perfect for the small office / home office, an environment that normally does not have a network set-up. That's why we offer direct printing and color scanning via the USB port, bypassing the need for network connectivity.

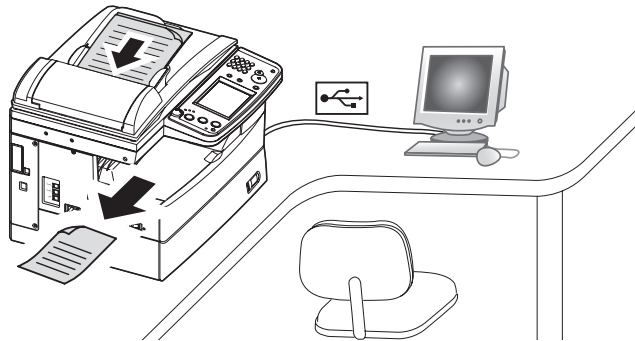

Paper Handling

An additional 500-sheet cassette is available as an option, bringing the total capacity to 1,050 sheets. This accommodates offices that utilize both letter and legal-sized paper, as well as applications that use large volumes of letter.

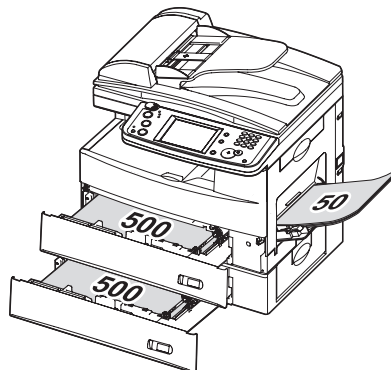

Chapter

1

Getting Started

Machine overview	1-2
Machine layout.....	1-2
Control panel overview	1-3
Operating tips	1-4
Changing modes.....	1-4
Operating the display	1-4
Display description	1-4
Key displays and functions	1-9
Entering characters	1-10
Memory back-up	1-13
Initial setup	1-14
Clearing stored settings	1-14
Getting started.....	1-15
Specifying the initial settings	1-16
Using the Energy save mode.....	1-23
Document and paper handling.....	1-24
Document handling	1-24
Paper handling.....	1-26

Machine overview

Machine layout

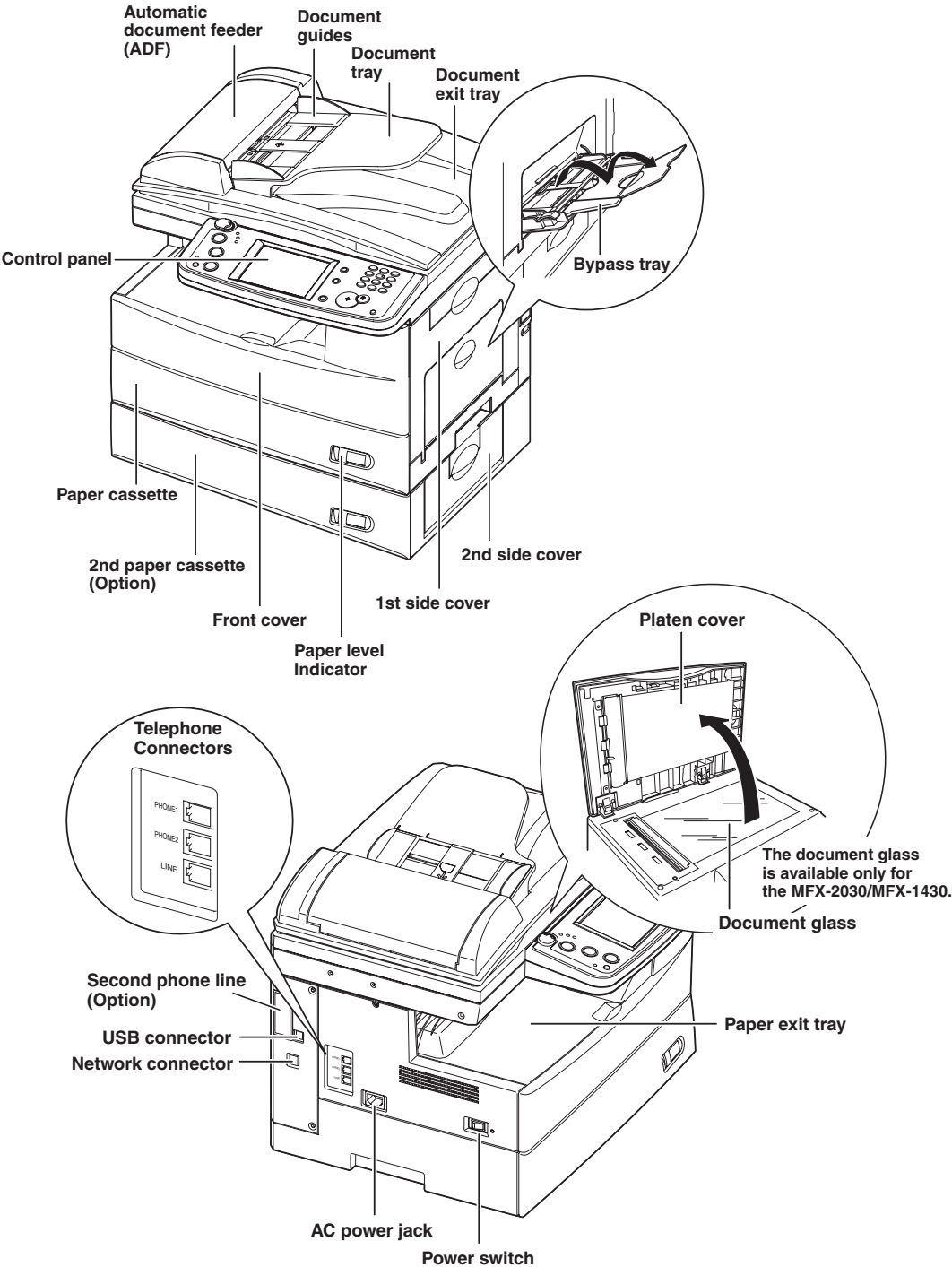

Control panel overview

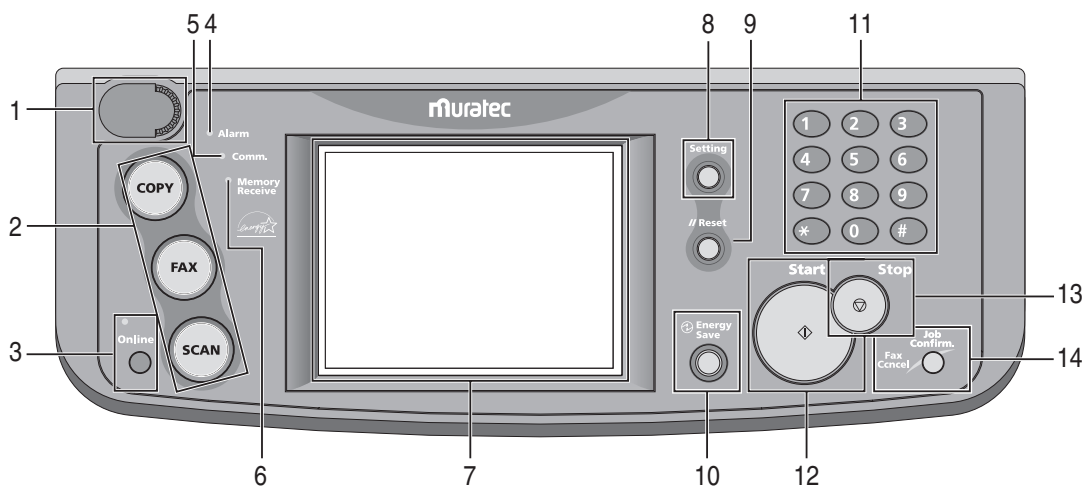

1 Display Contrast

This adjusts the brightness of the display.

2 Mode keys

Press these keys to toggle between modes. The key will be highlighted after it is pressed.

3 Online

Shows whether or not the PC printing function is available.

For details of PC printing, see the PDF manual on the Printer & Scanner Manual [CD].

4 Alarm lamp

Lights when an error occurs.

5 Comm. lamp

Lights when the machine is communicating with another machine.

6 Memory Receive lamp

Lights when the machine is out of paper and documents are being stored into memory.

7 Display

Displays machine status, interactive displays, and touch keys for selecting all functions.

8 Setting

Press this key to view/edit machine default settings.

9 Reset

Returns the menu to the standby mode and resets all settings back to their defaults.

10 Energy Save

Press this to put the machine into the energy save mode and reduce power consumption.

11 Numeric keys

Use these keys to enter numerical values, such as fax/phone numbers.

12 Start

Executes the operation.

13 Stop

Stops the machine's operation. To stop a fax transmission, press [Fax Cancel/Job Confirm.].

14 Fax Cancel/Job Confirm.

Press this to cancel or review stored jobs, or to review the results of a communication.

Operating tips

Changing modes

You can switch to the Copy, Fax or Scan standby mode by pressing the mode keys.

NOTE: You cannot switch the mode in any of the following cases:

- While scanning a document.
- During a real time transmission.

Operating the display

To select a function or to set a setting, lightly touch the desired function or setting shown on the display.

⚠CAUTION: Never push down on the display with force, and never use a hard or pointed object to make a selection in the display.

Display description

You can directly touch keys on the control panel for machine operation.

Functions and values can be changed by touching the keys or tabs shown on the display.

Copy standby mode

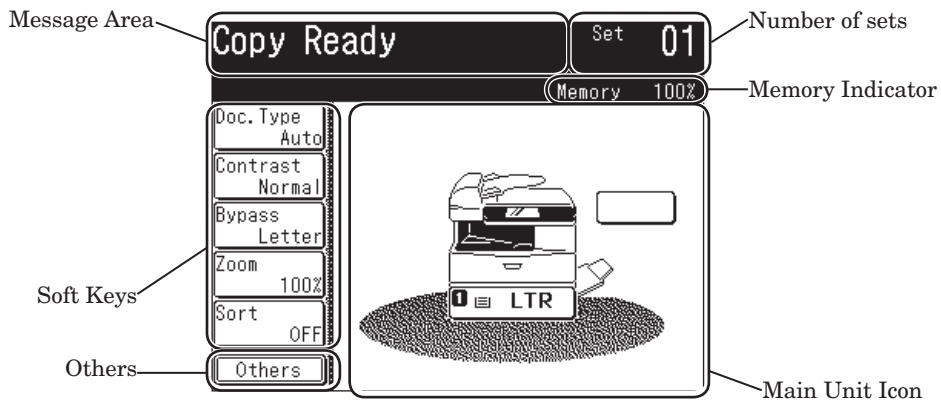

Name	Function
Message Area	Displays the machine's current status, operation instructions, error messages and other information.
Number of sets	Indicates the print quantity entered from the control panel.
Memory Indicator	Indicates the remaining memory available for the next operation.
Main Unit Icon	Displays the status of the main unit. This can also be used to select the cassette/bypass tray for a copy job.
Soft Keys	Displays five functions frequently used. You can assign other functions to soft key according your needs. (See "Soft key" on page 10-2.)
Others	Press this to display the various copy functions.

Fax standby mode

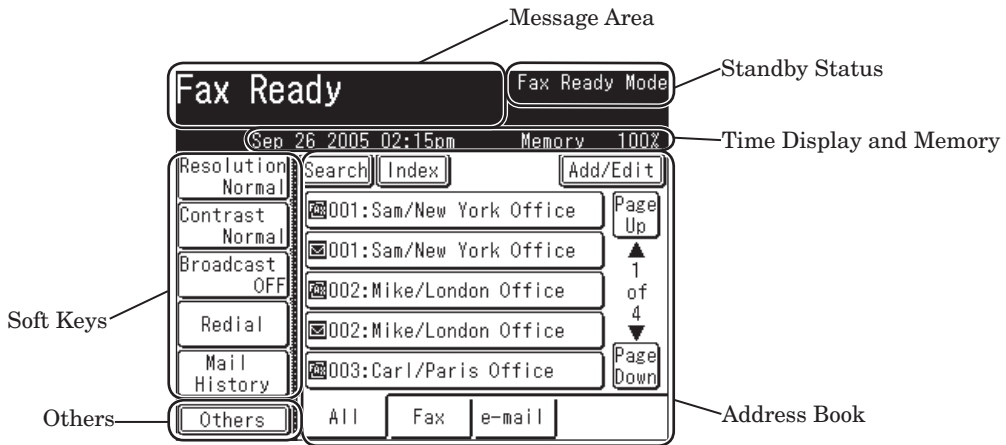

Name	Function
Message Area	Displays the machine's current status, operation instructions, error messages and other information.
Standby Status	Displays the fax reception mode.
Time Display and Memory	Displays the current date, time and amount of fax memory available.
Address Book	Displays the registered destinations.
Soft Keys	Displays five functions frequently used. You can assign other functions to soft key according your needs. (See "Soft key" on page 10-2.)
Others	Press this to display the various fax functions.
Search	Press this to search the destination from your Address Book or your LDAP server.
Index	Displays the destinations in alphabetical or group or numeric order.
Add/Edit	Adds or edits the destination.

Scan standby mode (scan to e-mail)

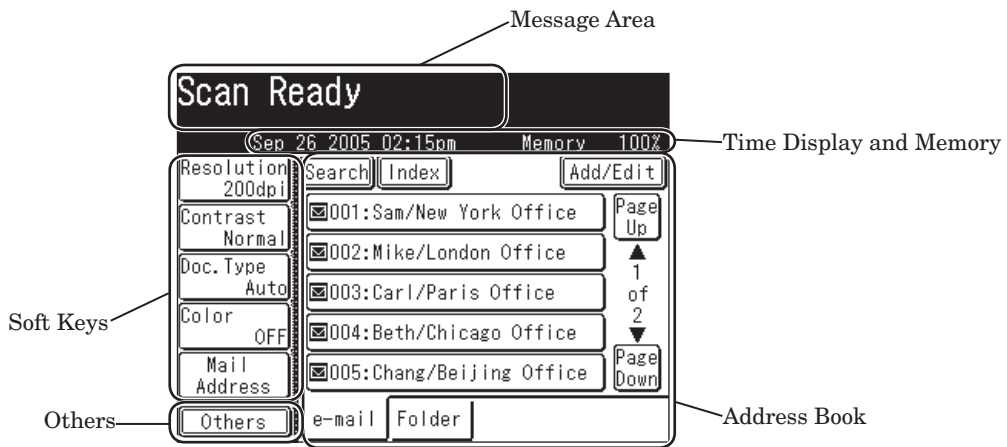

Name	Function
Message Area	Displays the machine's current status, operation instructions, error messages and other information.
Time Display and Memory	Displays the current date, time and amount of scan memory available.
Address Book	Displays the registered destinations.
Soft Keys	Displays five functions frequently used. You can assign other functions to soft key according your needs. (See "Soft key" on page 10-2.)
Others	Press this to display the various scan functions.
Search	Press this to search the destination from your Address Book or your LDAP server.
Index	Displays the destinations in alphabetical or group or numeric order.
Add/Edit	Adds or edits the destination.

Scan standby mode (scan to folder)

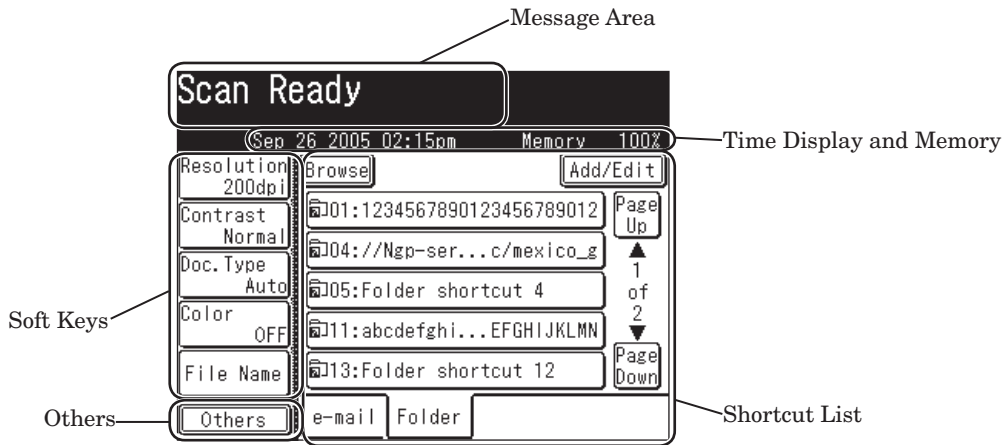

Name	Function
Message Area	Displays the machine's current status, operation instructions, error messages and other information.
Time Display and Memory	Displays the current date, time and amount of scan memory available.
Shortcut List	Displays the registered folder shortcuts.
Soft Keys	Displays five functions frequently used. You can assign other functions to soft key according your needs. (See "Soft key" on page 10-2.)
Others	Press this to display the various scan functions.
Browse	Press this to browse through the network. Used to save the scanned image to your desired folder.
Add/Edit	Adds or edits the folder shortcuts.

Scan standby mode (scan to FTP)

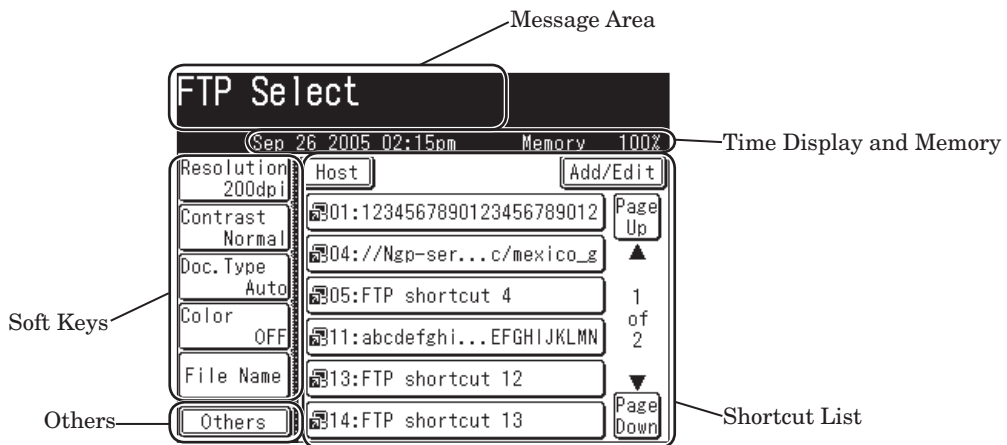

Name	Function
Message Area	Displays the machine's current status, operation instructions, error messages and other information.
Time Display and Memory	Displays the current date, time and amount of scan memory available.
Shortcut List	Displays the registered FTP server shortcuts.
Soft Keys	Displays five functions frequently used. You can assign other functions to soft key according your needs. (See "Soft key" on page 10-2.)
Others	Press this to display the various scan functions.
Host	Press this to enter the FTP server's link. Used to save the scanned image to your desired FTP server.
Add/Edit	Adds or edits the FTP server shortcuts.

Key displays and functions

□ Keys on the display

To set a function, press this key to open the setting display. Some keys switch ON/OFF by simply touching them. When another setting is required to be set first or when the function cannot be combined with another function, the key will be grayed-out and cannot be selected. Also, the selected key will be highlighted.



<When a key cannot be selected>



<Before selection>



<After selection>



□ Cursor keys, [Prev] & [Next], [Page Up] & [Page Down]

These keys are used when entering numbers or selecting functions. They are also used when changing displays.

<Number Entry>



<Display Change>

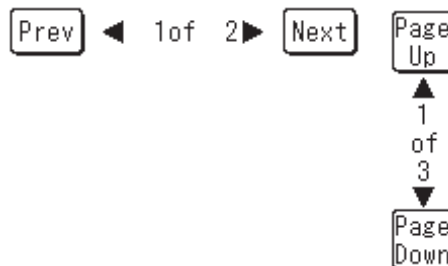

□ [Back], [Cancel], [Enter]

[Back].....Goes back to the previous menu level.

[Cancel].....Returns you to the default display without resetting previously registered functions.

[Enter].....Sets the function or number specified on the display.

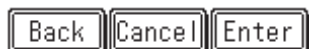

Entering characters

QWERTY keypad

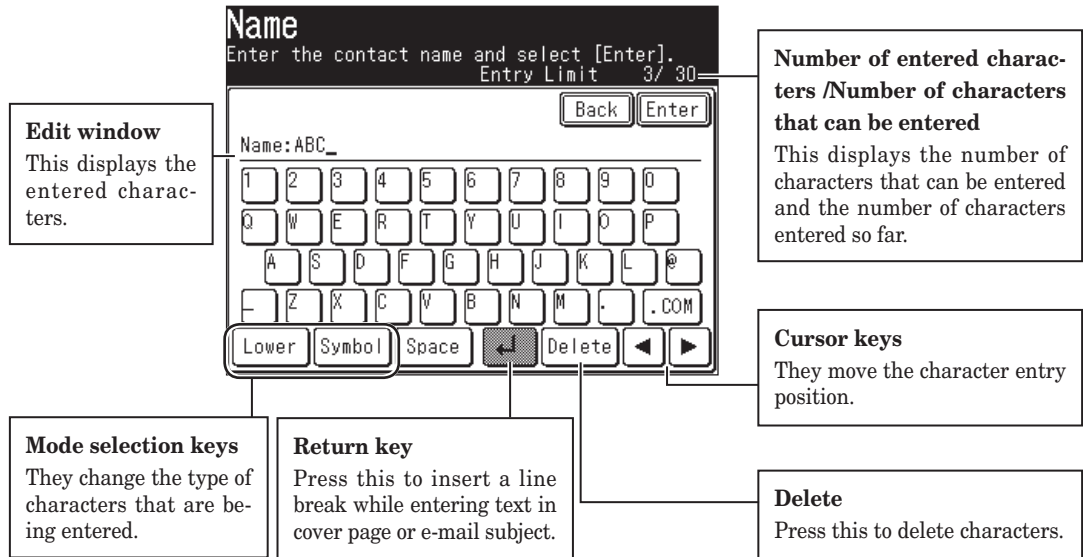

Entering alpha characters

Select the characters to be entered from the QWERTY keypad.



□ Upper and lower case characters

Press [Lower] to enter the lower case letters.

Press [Upper] to enter the upper case letters.



Entering symbols and special characters

Select [Symbol] to enter the symbol or special characters.

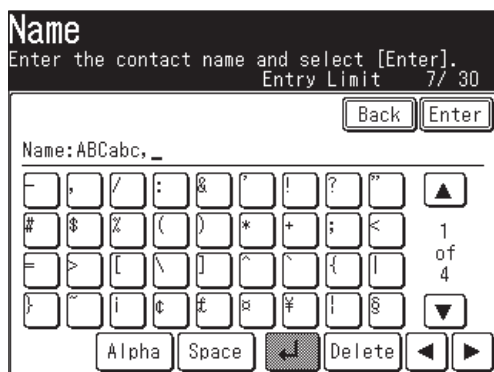

- The “_”, “.”, “@” and “.com” can be entered in the alpha entry display.

The symbols that can be entered are as follows.

Page	Symbol									
1/4	—	,	/	:	&	'	!	?	”	
	#	\$	%	()	*	+	;	<	
	=	>	[\]	^	`	{		
	}	~	;	¢	£	¤	¥	¦	§	
2/4	¨	©	ª	«	¬	-	®	¯	°	
	±	²	³	´	µ	¶	·	¸	¹	
	º	»	¼	½	¾	¿	À	Á	Â	
	Ã	Ä	Å	Æ	Ç	È	É	Ê	Ë	
3/4	Ì	Í	Î	Ï	Ð	Ñ	Ò	Ó	Ô	
	Õ	Ö	×	Ø	Ù	Ú	Û	Ü	Ý	
	Þ	ß	à	á	â	ã	ä	å	æ	
	ç	è	é	ê	ë	ì	í	î	ï	
4/4	ð	ñ	ò	ó	ô	õ	ö	÷	ø	
	ù	ú	û	ü	ý	b	ÿ			

Entering numbers

□ Using the numeric keys

Enter numbers by pressing the numeric keys.

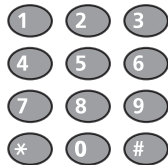

□ Using the QWERTY keypad

Select the numbers to be entered from the QWERTY keypad.



Entering spaces

To enter a space, press [Space] while entering.



Deleting/Inserting characters

To delete a character, use [◀] [▶] to move the cursor to the character you want to delete, and then press [Delete].

To insert a character, use [◀] [▶] to move the cursor to the insert position and enter the character.

NOTE: The last entered character can be deleted by pressing [Delete].

Memory back-up

Image data stored in memory is held under the following conditions, even if a power failure occurs or the machine is shut down.

- Image data stored in memory is held for the following period of time. Note that the power of the machine should be turned ON for at least 24 hours beforehand.
- The time it takes for data back-up depends on the size of the memory.
 - 8 MB : Approx. 72 hours (standard memory)
 - 40 MB: Approx. 24 hours (if the 32 MB Memory Extension kit is installed)

When you turn the power ON after it is OFF for a long period, the Time Setting display may appear. In this case, be sure to perform the time setting before using the machine. You cannot use the machine without the time setting.

Initial setup

Clearing stored settings

Before using your machine, clear the built-in user data. This insures that the memory will hold only your settings.

IMPORTANT: After specifying the initial settings, do not clear the memory again without consulting your Muratec dealer.

To clear the machine's memory:

- 1 Press [Setting], [✖], [0], [2].



- 2 If you want to clear the memory, press [Yes].
If you do not want to clear the memory, press [No].

Getting started

In some countries you are required by law to indicate your name and fax number on every fax you send.

YOU MUST THEREFORE STORE YOUR NAME (OR COMPANY NAME) AND FAX NUMBER IN YOUR MACHINE BEFORE USING IT.

Every fax page you send arrives at the receiving machine with a single line of text at the very top of the page. This text lists a name, called the Transmit Terminal Identifier (TTI), and a fax number.

Under “Specifying the initial settings” next page, you can setup the following items including your name and fax number.

- Language
- Current date and time
- Automatic daylight saving time detection
- Broadcasting
- Phone dial type
- Fax reception mode
- Dial tone detection
- TTI 1 / TTI 2 / TTI 3
- Default TTI
- Your fax number
- Time zone

These settings can be changed at any time.

Specifying the initial settings

If you press [Reset] during the initial setup, your machine will return to the standby mode. You can save the settings you have made by selecting [Enter] as shown below.

- 1 Press [Setting].
- 2 Press [User Install].

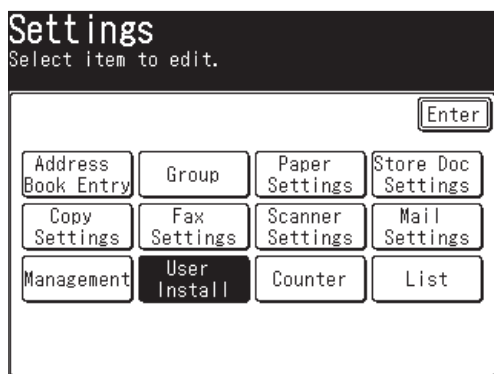

- 3 The user install list is displayed.

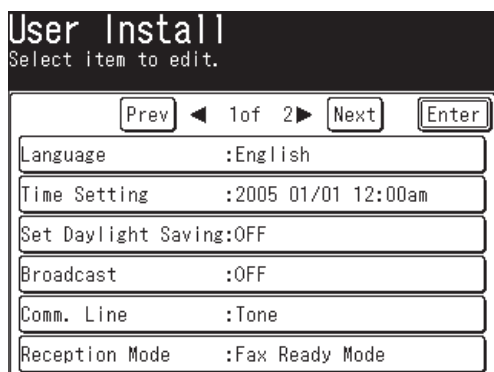

- 4 Set the desired settings. (See page 1-17 to 1-22)
- 5 After setting all the items, press [Reset] to return to the standby mode. Print out the Fax Settings List from the [List] menu to insure that your settings are correct. (See page 12-4)

Language

Select the machine's display language - English, French or Spanish. The selected language will be applied to the list printouts as well.

- 1 Press [Language].
Languages available to use is displayed.
- 2 Select the language.
- 3 Press [Enter] to save the setting.

NOTE: Some versions do not support the language conversion.

Date & Time

Set the current time in the order of year (4 digits), month (2 digits), day (2 digits), hour (12-hour clock, 2 digits), and minutes (2 digits).

- 1 Press [Time Setting].
- 2 Use [▲] [▼] [◀] [▶] or the numeric keys to enter the current date and time.

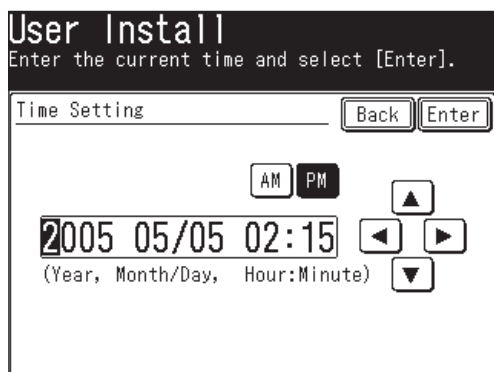

- 3 Press [Enter] to save the setting.

Daylight savings

Select whether to activate the daylight savings feature.

- 1** Press [Set Daylight Saving].
- 2** Select [ON] to activate daylight savings, and [OFF] to deactivate it.

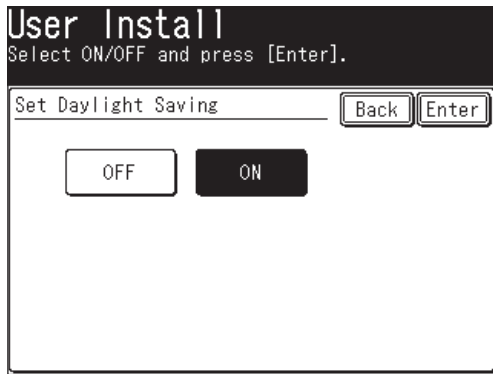

- 3** Press [Enter] to save the setting.

Broadcasting

Set the broadcast transmission option.

If you select [ON], you need to select a destination(s) and press [Start] in order to transmit faxes.

If you select [OFF], you can transmit faxes by simply touching the destination key.

- 1** Press [Broadcast].
- 2** Select [ON] or [OFF].

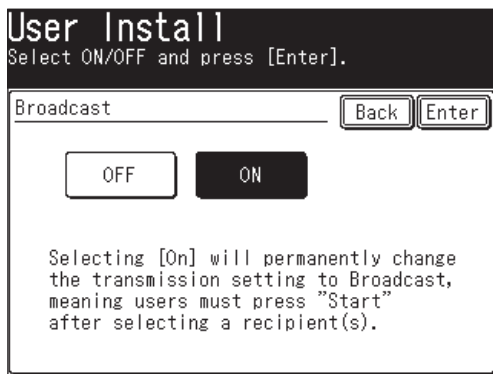

If you select [ON], you can select two or more destinations from the address book at a transmission.

If you select [OFF], the transmission will immediately start when you press a destination from the address book.

- 3** Press [Enter] to save the setting.

Phone dialing type

Set the dialing type needed for the fax machine, either “Tone” or “Pulse”.

- 1 Press [Comm. Line].
- 2 Select the dialing type.

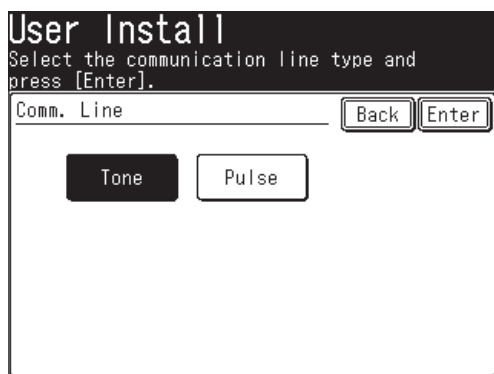

- 3 Press [Enter] to save the setting.

Fax reception mode

Select the reception mode that best matches the machine usage.

- 1 Press [Reception Mode].
- 2 Select the reception mode. (For description of the reception modes, see “Selecting the reception mode” on page 3-15.)

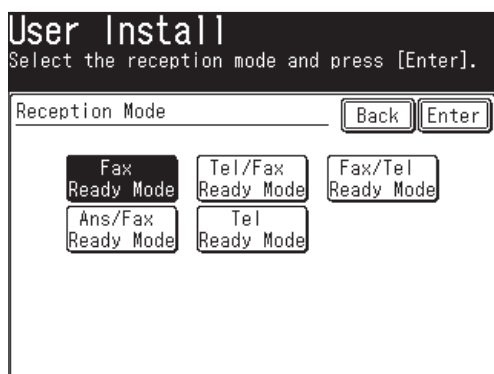

- 3 Press [Enter] to save the setting.

Dial tone detection

Select if you set the dial tone detection.
Select [OFF] normally.

- 1 Press [DialTone Detect].
- 2 Select [ON] to detect the dial tone, and [OFF] if the detection is not required.



If you select [ON], you cannot transmit the faxes through the line that does not acquire the dial tone.

- 3 Press [Enter] to save the setting.

TTI (your name)

Three types of TTI (Transmit Terminal Identifier) can be set.

- 1 Press [TTI Enter/Edit].
- 2 Press [TTI 1].
- 3 Enter the TTI.



- 4 Press [Enter] after the entry to save it.
(For description of character entry, see "Entering characters" on page 1-10.)
- 5 In the same way, you can enter the TTI 2 and TTI 3.

Selecting the default TTI

Select the TTI that will be used most often.

- 1 Press [Default TTI].
- 2 Select the TTI to be shown at the top of faxes you send.

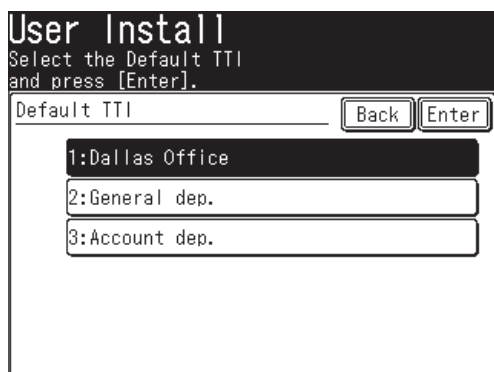

- 3 Press [Enter] to save the setting.

Entering your fax number

- 1 Press [TTI Number].
- 2 Use the numeric key to enter the TTI number (your fax machine's phone number).

This number can contain up to 20 characters.

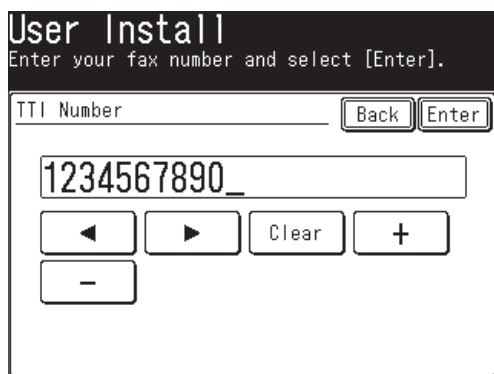

- To enter "+" symbol before your country code, press [+].
- To make long numbers easier to read, press [-] to enter it.
- To erase a number, press [Clear].
- To change just one number, press [◀] or [▶] to move the cursor then press [Clear] to erase the number. Then re-enter the correct number.

Time Zone

“Time zones” refer to the difference in time (up to ± 12 hours) between countries from the Greenwich Observatory in England, which is taken to be standard time, and to regions that use the same difference.

- 1 Press [Time Zone].
- 2 Use the numeric keys to enter your time zone.

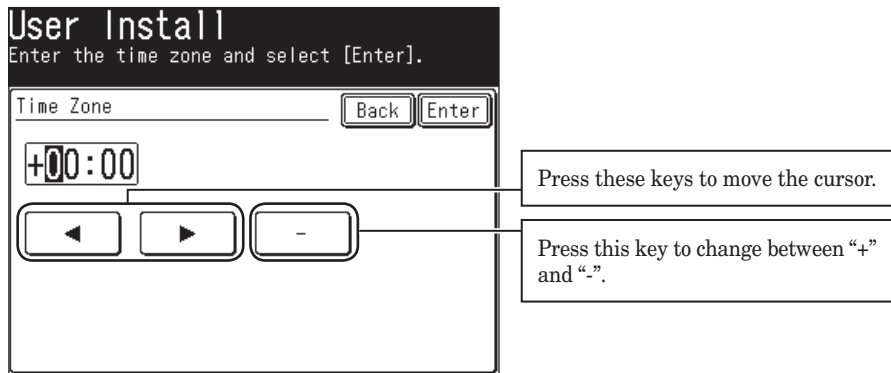

Example of Time Zone:

- (GMT -11:00) Midway Island
- (GMT -10:00) Hawaii
- (GMT -09:00) Alaska
- (GMT -08:00) Pacific Time (US & Canada)
- (GMT -07:00) Mountain Time (US & Canada)
- (GMT -06:00) Central Time (US & Canada)
- (GMT -05:00) Eastern Time (US & Canada)
- (GMT -04:00) Atlantic Time (Canada)
- (GMT -03:30) Newfoundland
- (GMT) Greenwich Mean Time: Dublin, Edinburgh, Lisbon, London
- (GMT +01:00) Amsterdam, Berlin, Bern, Rome, Stockholm, Vienna
- (GMT +01:00) Belgrade, Bratislava, Budapest, Ljubljana, Prague
- (GMT +01:00) Brussels, Copenhagen, Madrid, Paris
- (GMT +09:00) Osaka, Sapporo, Tokyo, Seoul
- (GMT +10:00) Guam

- 3 Press [Enter] to save the setting.

Using the Energy save mode

When the machine has been idle for a predetermined amount of time, the Energy Save mode will activate to conserve power. By default, the machine will automatically enter the Energy Save mode after 5 minutes of idle time.

While the Energy Save mode:

- The machine stops the pre-heating for printing and turn off the display. (However, the scanner lamp will not shut off.)
- [Energy Save] lights in green to indicates that the machine is in the Energy Save mode.
- Press [Energy Save] to recover from the Energy Save mode.

-
- NOTE:**
- The Energy Save mode will not activate in the following cases, even if you press [Energy Save].
 - While scanning documents
 - When a document is set in the ADF
 - *Energy Save mode will not activate when “Calibrating Scanner” appears in the display.
 - When the print error occurs (ex: out-of-paper status, paper jam)
 - When the telephone line is used
 - When cooling fan is rotating
 - For the Energy Save Mode setting, see page 12-12.
 - Only the display backlight will be turned out in the following cases.
 - When the machine is not used for more than 10 minutes. (The backlight may not be turned out in some cases, such as while scanning documents.)
 - When printing received documents of fax/internet fax, during PC printing, or when automatically printing lists (ex: check message) in the Energy Save mode.

To turn on the backlight, press any key on the display or on the control panel.

Document and paper handling

Document handling

Be sure to read the following guidelines before you begin faxing, copying or scanning.

Acceptable documents

□ ADF

	Single-sheet	Multiple-sheet
Size (W × L)	Max. 8.5 × 35.43 in.* (216 × 900 mm)* Min. 4.72 × 3.94 in. (120 × 100 mm)	Max. 8.5 × 14 in. (216 × 356 mm) Min. 8.5 × 5.49 in. (216 × 139.5 mm)
Quantity	1 sheet	Max. 80 sheets of Letter-, Legal-, or Half-letter  - size sheets (75 g/m ² or 20lb. paper)
Weight	35.0 to 128.0 g/m ²	52.0 to 105.0 g/m ²
Thickness	0.05 to 0.15 mm	0.07 to 0.12 mm
Document type	Plain paper	Plain paper

* Real time transmission with super-fine resolution, 8.5 × 14 in. (216 × 356 mm).

□ Document glass

The document glass is available only for MFX-2030/MFX-1430 model.

Size (W × L)	Max. 8.5 × 14 in. (216 × 356 mm)
Quantity	1 sheet
Weight	—
Thickness	—
Document type	Plain paper and other types of documents.

Items to avoid

To prevent jams and damage to the automatic document feeder, **do not** use the following:

- Folded, curled, torn, wrinkled or very thin pages
- Documents with staples, glue, tape, paper clips or still-wet correction fluid
- “Sticky notes” (or documents with “sticky notes” attached)
- Cardboard, newspaper or fabric
- Pages with duplicating carbon on either side
- Credit cards or any small, thick items
- OHP transparency film

Scanning area

The scanned area is shown below.

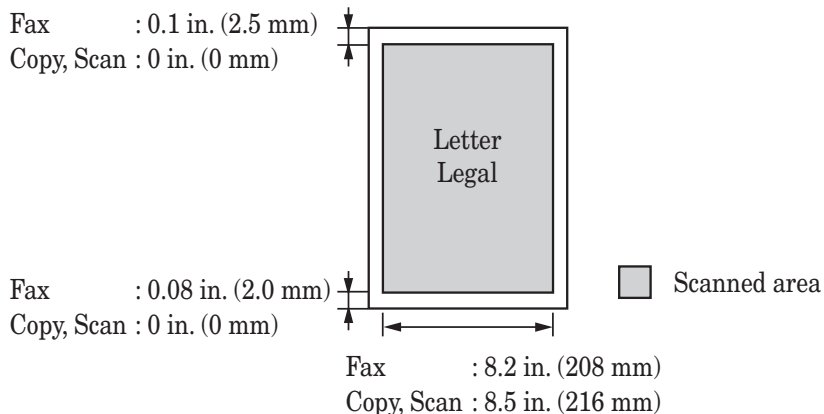

Loading documents in the ADF

- 1 Insert the documents face-up, **top edge first**.
- 2 Adjust the document guides to the document size.

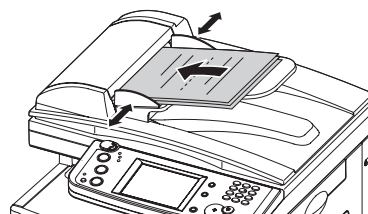

Loading the document on the document glass

- 1 Make sure there is no documents in the ADF.
- 2 Lift the platen cover.
- 3 **Face down** the document and place it on the document glass. The document should be aligned to the **upper left corner**.
- 4 Gently close the platen cover.

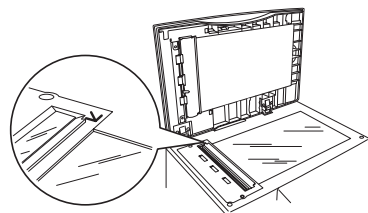

IMPORTANT: When copying a bound document, such as a book, the copied image may contain some black areas. To reduce this effect, hold down the document to prevent its bound part from rising. However, do not press too strongly. This may break the document glass and cause an injury.



Paper handling

Acceptable paper sizes

❑ Paper cassette

Paper type	Paper size	Quantity
Plain paper (weight: 20–24 lbs.)	Letter, Legal, Half-letter 	500 sheets (weight: 20 lbs.)

❑ Bypass tray

Paper type	Paper size	Quantity
Plain paper (weight: 20–28 lbs.)	Letter, Legal, Half-letter  , Executive A4, A5, A5  , A6, F4,	50 sheets (weight: 20 lbs.)
	Custom sizes <ul style="list-style-type: none">• Width: 3.8 to 8.5 in. (97 to 216 mm)• Length: 5.5 to 14 in. (140 to 356 mm)	1 sheet
Envelopes	DL: 4.33 × 8.66 in. (110 × 220 mm) Com#10: 4.125 × 9.5 in. (105 × 241 mm) Monarch: 3.875 × 7.5 in. (98.4 × 190.5 mm)	1 envelope
Postcard	3.94 × 5.83 in. (100 × 148 mm)	20 sheets
Transparency	Letter	20 sheets

- Custom-sized paper can be used for PC printing only.
- Do not use envelopes with double flaps or pressure seals since these do not feed properly.
- If using a transparency (OHP) film, be sure that the film does not have a paper backing and/or leading strip. If it does, remove the paper backing and/or strip before loading. Only the film should go in, film with paper backing or a leading strip should not be fed.

❑ Duplex printing

The duplex printing unit is required in order to perform two-sided printing.

Paper type	Paper size
Plain paper (weight: 20–24 lbs.)	Letter, Legal, A4, F4

Paper to avoid:

To prevent jams and damage to your machine, **do not** use the following:

- Creased paper
- Wrinkled paper
- Folded paper
- Curled paper
- Torn paper
- Carbon paper
- Moist paper
- Very thin paper
- Very thick paper
- Paper previously printed on by a printer
- Paper with holes
- Envelopes with pressure seals
- Extremely shiny or highly textured paper

Printable area

The printable area is shown below.

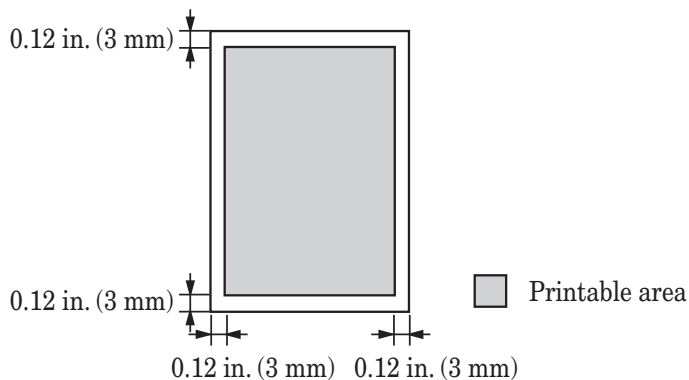

Loading paper into the paper cassettes

NOTE: After you load paper into the paper cassettes, you need to set the paper size on the control panel. See “Setting of the paper size” on page 1-30.

- 1 Pull the handle to open the paper cassette.

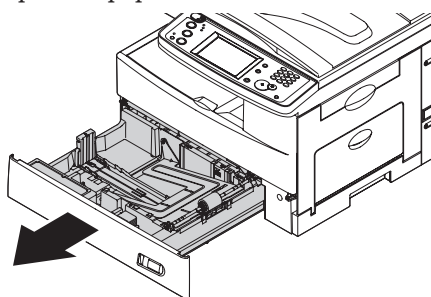

- 2 Press down the paper lifting plate until it locks in position.

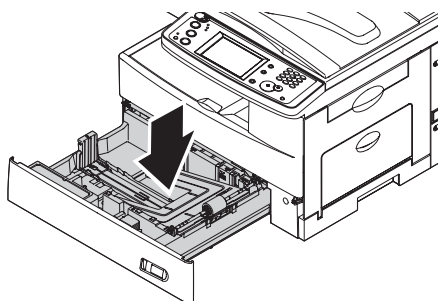

- 3 Adjust the rear paper guide to the desired paper length.

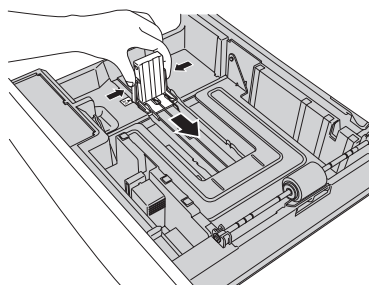

4 Load the paper into the cassette.

- Before you insert paper in the cassette, stack it so the leading edge and sides of the paper are even.
- Do not stack the paper over the limit mark inside of the cassette.

NOTE: To prevent paper jams, do not refill the paper cassette without first removing any remaining paper. In other words, do not just add sheets to an already-loaded stack.

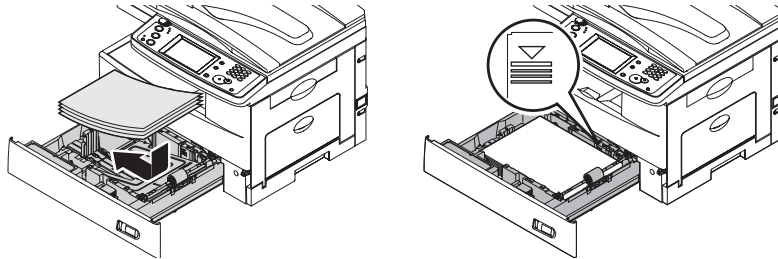

5 Pinch the side paper guide and adjust to the width of the stack.

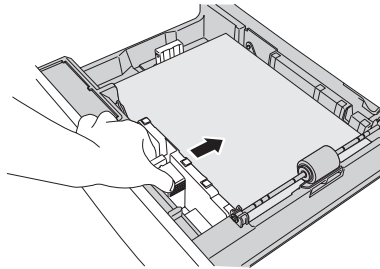

6 Close the paper cassette.

7 After loading paper in the paper cassette, you need to set the paper size.
(See “Setting the paper size” on page 1-30.)

8 Attach the paper size sticker supplied with your machine to the front of the cassette.

Loading paper into the bypass tray

When you need to use a paper size that is not currently loaded in the paper cassette, or when you want to print on an envelope, transparency film or custom sized paper, use the bypass tray.

NOTE: Only use print media specified under “Acceptable paper sizes” on page 1-26 to avoid paper jams and print quality problems.

- 1 Open the bypass tray on the right side of your machine. Unfold the paper support extension.

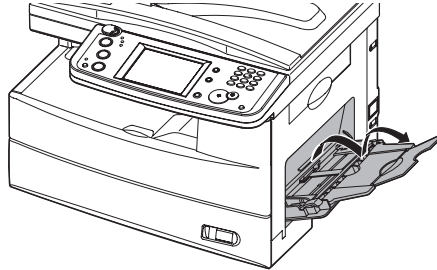

- 2 To set the paper, 1) raise the flapper release lever 2) load paper until it comes to a stop.

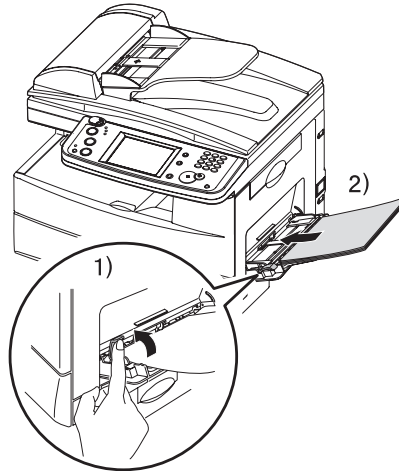

- 3 1) Adjust the paper guides to fit the paper, 2) then lower the flapper release lever.

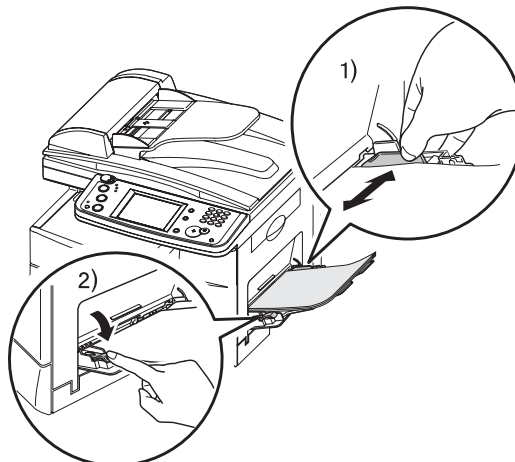

- 4 After loading paper into the bypass tray, you need to set the correct paper size. (See “Setting the paper size,” below.)

NOTE: You can also set the paper size for bypass tray by pressing [Bypass] in the Copy standby mode.

Setting the paper size

Default setting: *1st cassette: Letter; 2nd cassette (option): Letter; Bypass Tray: Letter*

After loading paper into the paper cassette/bypass tray, you need to set the correct paper size on the control panel by using the following procedure.

- 1 Press [Setting].
- 2 Press [Paper Settings].

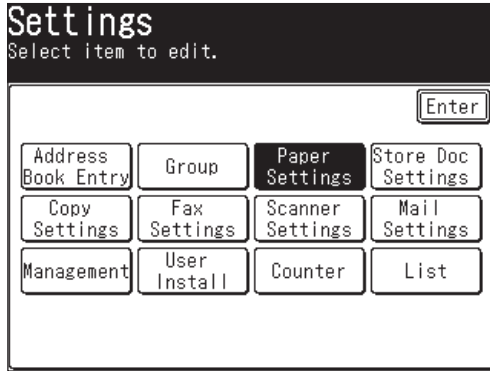

□ Setting the paper type for the 1st cassette

- 3 Press [Cassette 1].

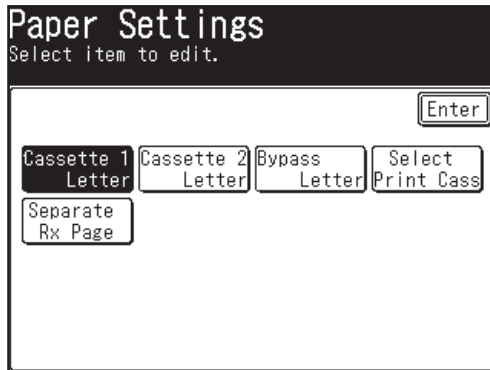

- 4 Select the paper size for the first cassette.

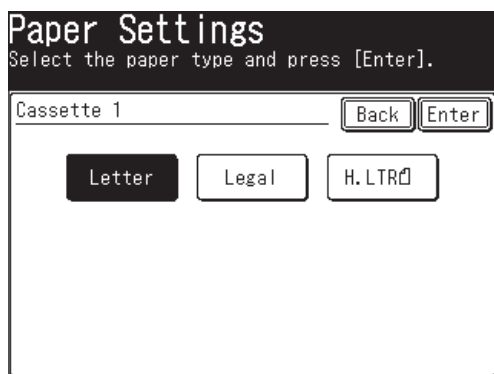

- 5 Press [Enter] to save the setting.

□ Setting the paper size for the 2nd cassette

- 3 Press [Cassette 2].
- 4 Select the paper size for the second cassette.

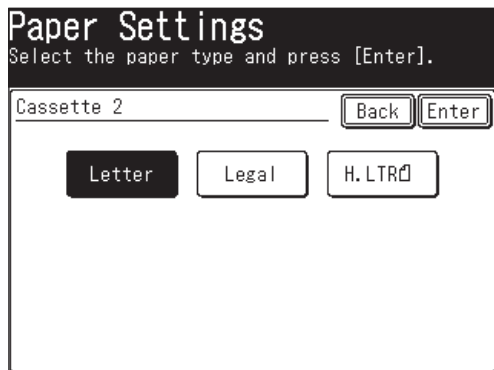

- 5 Press [Enter] to save the setting.

□ Setting bypass tray paper

3 Press [Bypass].

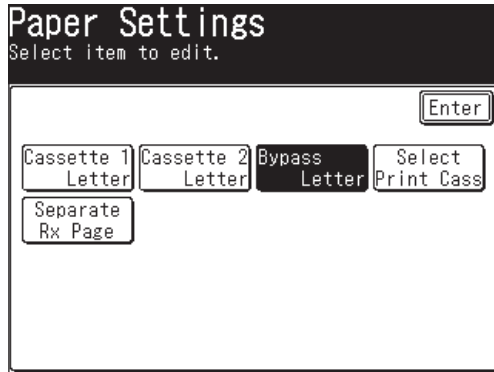

4 Select the paper size for the bypass tray.

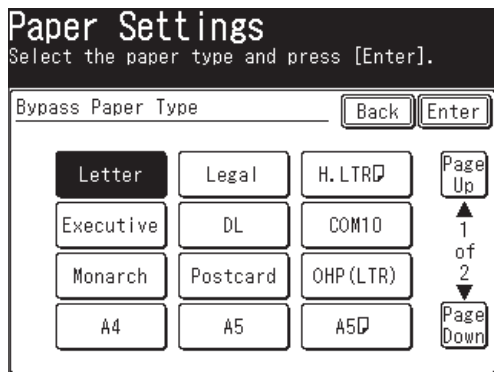

5 Press [Enter] to save the setting.

6 Press [Reset] to exit and return to the standby mode.

Chapter

2

Using the Address Book

The address book.....	2-2
The address book display	2-2
Special dialing characters	2-3
Registering destinations in Address Book.....	2-4
Registering or editing a destination	2-4
Alternative 1: Registering or editing directly into the address book....	2-7
Alternative 2: Registering or editing the fax number using the numeric keys...	2-8
Alternative 3: Registering an e-mail address using the QWERTY keypad....	2-9
Deleting a destination	2-10
Alternative: Deleting directly from the address book.....	2-11
How to dial using the address book	2-12
Call group dialing	2-14
Registering or editing a call group.....	2-14
Deleting a call group.....	2-15
How to dial using a call group.....	2-16
Making a phone call.....	2-19
How to dial using the address book	2-19
If the call fails	2-20
How to receive a phone call.....	2-20
Adjusting the optional handset volume.....	2-20
Adjusting the speaker volume.....	2-21

The address book

You can register up to 300 frequently used destinations into the address book. The destination name, fax number and e-mail address can be registered into the address book. You can also add these destinations into a group.

In addition, you can simply search the destination name registered in the address book.

- NOTE:**
- For details on registering or deleting destinations in address book, see page 2-4.
 - For details on address book dialing, see “How to dial using the address book” on page 2-12.
 - For details on call group dialing, see page 2-14.
 - For details on phone calling, see page 2-19.

The address book display

When you press the “All” tab in the address book display, all the registered destinations will be displayed. Press the “Fax” tab to show only the fax numbers that have been registered and the “e-mail” tab to show only the e-mail addresses that have been registered.

The displayed soft keys change depending on the tab you select (The order of displayed keys after pressing [Others] also changes, but the item description remain the same.)

Search
Press this to search a destination's fax number or e-mail address. (See page 5-15.)

Index
Displays the destinations in alphabetical or group or numeric order. (See page 2-3.)

Destination
This allows you to review to destinations you have selected/registered. 5 destinations are displayed at a time.

Resolution
Normal

Contrast
Normal

Broadcast
OFF

Redial

Mail History

Others

All **Fax** **e-mail**

Search **Index** **Add/Edit**

Page Up **Page Down**

1 of 4

Add/Edit
Press this to register a destination into the address book or edit an existing destination.

Page change keys
Press this to change the page view.

Page number
Currently displayed page/total pages.

Tabs
The registered destinations are listed by the sending method. Press a tab to display the classified destinations.

(When “All” tab is selected)

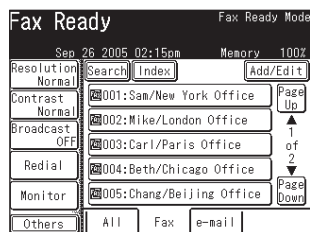

(When “Fax” tab is selected)

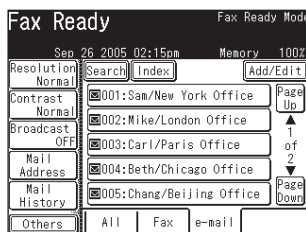

(When “e-mail” tab is selected)

[Index]

- [Symbol]..... When you press this key, only the destination names starting with a symbol or number are displayed.
- [Group]..... Lists the registered group names.
- [ABC] to [WXYZ] ... When you press one of these keys, only the destination names starting with the selected alpha characters will be displayed.

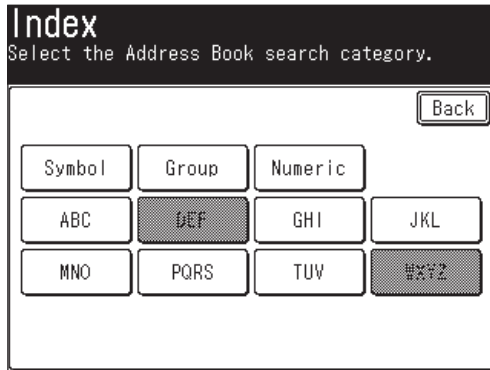

Special dialing characters

You can enter special dialing characters when registering the address book. The chart below briefly describes each of these characters.

Character	Description
/P	Each pause lasts two seconds. If you must wait for another dial tone or signal at any point in the dialing sequence, enter a pause. (You can change the pause length. See page 12-6.)
-	Makes long numbers easier to be read.
/T	Switches from pulse-dialing to tone-dialing. No need to use this character when using a tone line.
/N	Enters a "Dial prefix code" to access the alternative telephone network. "/N" must be entered before the first of number.

Registering destinations in Address Book

Registering or editing a destination

Your machine can store up to 300 destinations in the Address Book. Each destination is designated by a three-digit identifier code (001 through 300.)

- 1 Press [Setting].
- 2 Press [Address Book Entry].

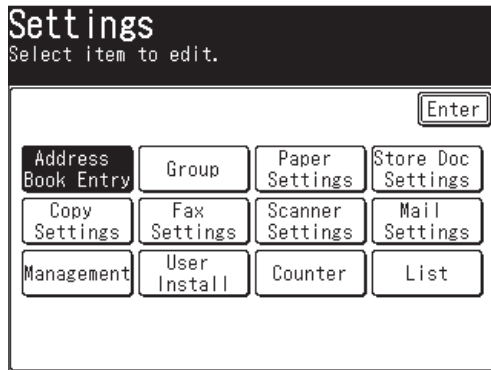

- 3 Press [Enter/Edit].

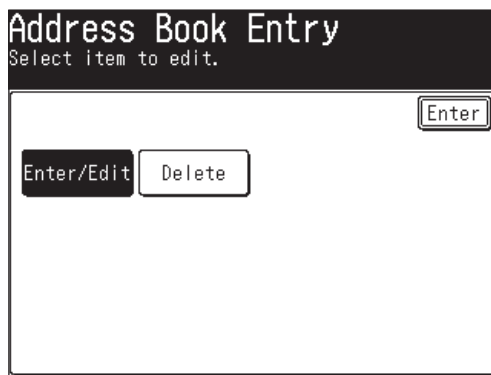

- 4 Press the address book number you want to register or edit.

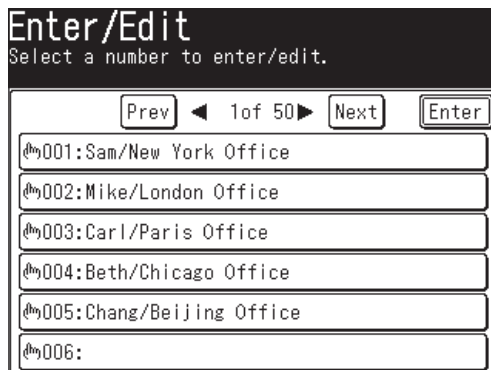

When registering an empty destination, the QWERTY keypad will be shown and the destination name must be registered. To edit the destination name, press [Name] and edit the name.

- 5 (1) Enter the destinations name.

The name field must be registered.

- Up to 30 characters can be entered.
- For details on character entry, see page 1-10.

- (2) Press [Enter].

- 6 (1) Press [Fax No.].

- (2) Use the numeric keys to enter the destinations fax number. (Up to 40 digits)

You must register either the fax number or e-mail address.

- Pause and other dialing symbols can be also entered. (See “Special dialing characters” on page 2-3.)

- (3) Press [Enter].

- 7** If you want to add this destination to a call group:
 (You can add either the fax number, e-mail address or both to a call group.)
- Call groups must be registered in advance. (For details on registering call groups, see page 2-14.)
 - Up to 32 groups can be registered.

(1) Press [Group].

(2) Select the applicable group(s).

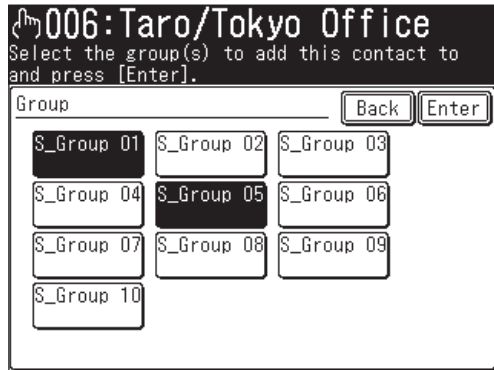

(3) Press [Enter].

- 8** If you want to enter the e-mail address:

(1) Press [e-mail].

(2) Enter the e-mail address.



You must register either the fax number or e-mail address.

- Up to 50 characters can be entered.
- For details on character entry, see page 1-10.

(3) Press [Enter].

- 9** If you want to add this destination to a call group:

- Call groups must be registered in advance. (For details on registering call groups, see page 2-14.)

- Up to 32 groups can be registered.

(1) Press [Group].

(2) Select the applicable group(s).

(3) Press [Enter].

- 10 Press [Enter] to save the setting.

006:Taro/Tokyo Office
Select the address book item to enter/edit.

Back Enter

Name :Taro/Tokyo Office

Fax No. :81-75-6622-8960

Group :S_Group 01,S_Group 05

e-mail :taro.h@muratec.com

Group :S_Group 01,S_Group 05

- 11 The registration destinations will be displayed.
- 12 To register another destination, repeat the procedure from step 4.
Press [Reset] to exit the operation and return to the standby mode.

NOTE: To print a list of address book entries, press [Setting], [List], [Address Book], then [Yes].

Alternative 1: Registering or editing directly into the address book

- 1 Press [FAX] to display the Fax standby mode.
- 2 Press [Add/Edit].

Fax Ready Fax Ready Mode

Sep 26 2005 02:15pm Memory 100%

Resolution Normal Search Index Add/Edit

Contrast Normal

Broadcast OFF

Redial

Mail History

Others All Fax e-mail

001:Sam/New York Office Page Up

001:Sam/New York Office

002:Mike/London Office 1 of 4

002:Mike/London Office Page Down

003:Carl/Paris Office

- 3 Following the operation from step 4 in “Registering or editing a destination”.

Alternative 2: Registering or editing the fax number using the numeric keys

- 1 Press [FAX] to display the Fax standby mode.
- 2 Use the numeric keys to enter the destination's fax number.
- 3 Press [Register].

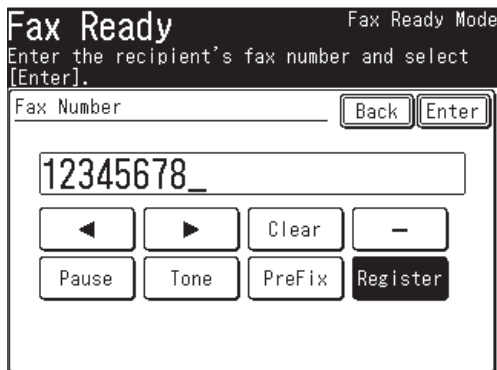

- 4 Select the address book number you want to register using [▲] or [▼], then select [Yes].

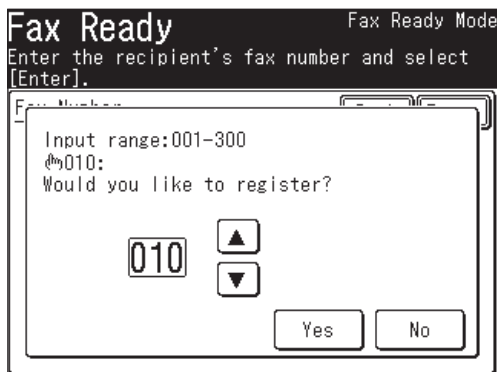

Unregistered number is displayed first. If you select an address book number that has already been registered, the fax number will be overwritten with the new number.

- 5 Follow steps 5 to 12 on pages 2-5 to 2-7.

Alternative 3: Registering an e-mail address using the QWERTY keypad

- 1 Press [FAX] to display the Fax standby mode.
- 2 Press “e-mail” tab.
- 3 Press [Mail Address].

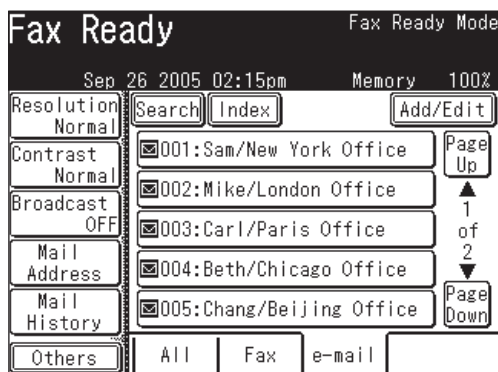

(When “e-mail” tab is selected)

- 4 Use the QWERTY keypad to enter the destination’s e-mail address.
- 5 Press [Register].



- 6 Select the address book number you want to register using [▲] [▼] or the numeric keys, then select [Yes].



Unregistered number is displayed first. If you select an address book number that has already been registered, the e-mail address will be overwritten with the new address.

- 7 Follow steps 5 to 12 on pages 2-5 to 2-7.

Deleting a destination

- 1 Press [Setting].
- 2 Press [Address Book Entry], then [Delete].

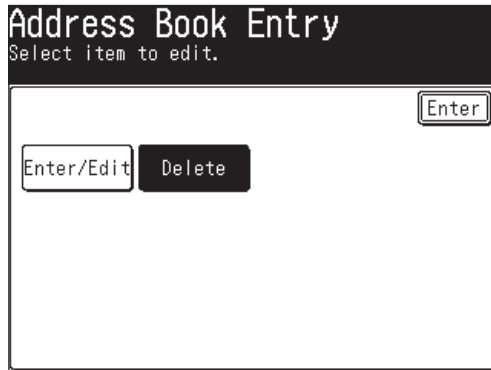

- 3 Select the address book number you want to delete.

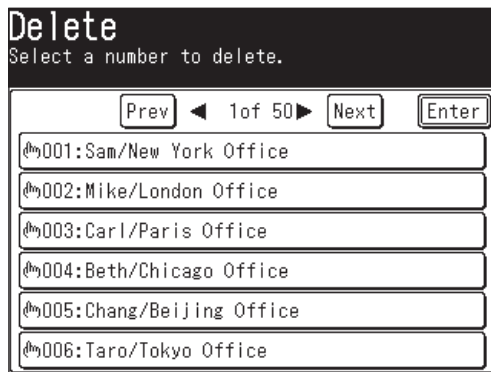

- 4 Press [Yes] to delete.

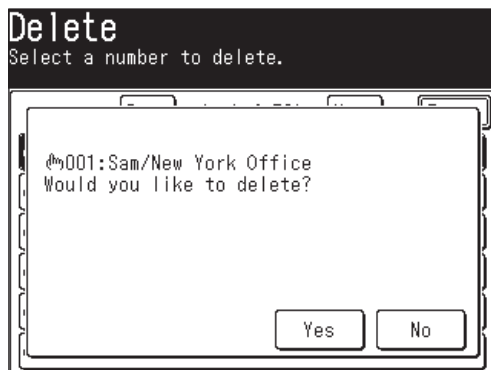

Press [No] to return to step 3 without deleting the number.

- 5 To delete another destination, repeat steps 3 to 4. Otherwise, press [Reset] to return to the standby mode.

Alternative: Deleting directly from the address book

- 1 Press [FAX] to display the Fax standby mode.
- 2 Press [Add/Edit].
- 3 Select the address book number you want to delete.

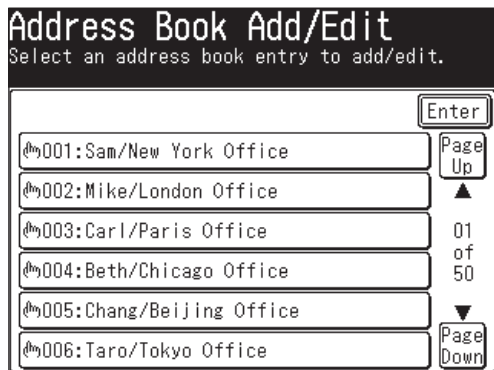

- 4 Press [Delete].

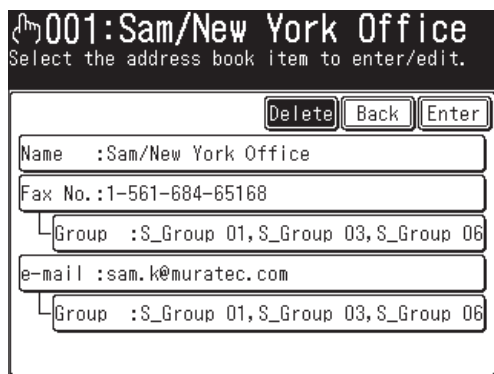

- 5 Press [Yes] to delete.

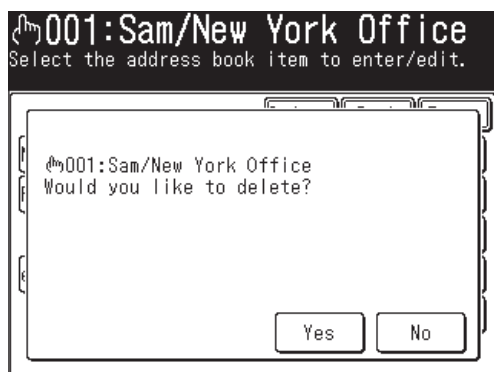

Press [No] to return to step 4 without deleting the number.

How to dial using the address book

Sending a fax or e-mail using the address book

- 1 Set the document.
- 2 Press [FAX] to display the Fax standby mode.
- 3 Adjust the document resolution and contrast, if necessary.
- 4 (1) Select the tab that contains the destination you want to send to.

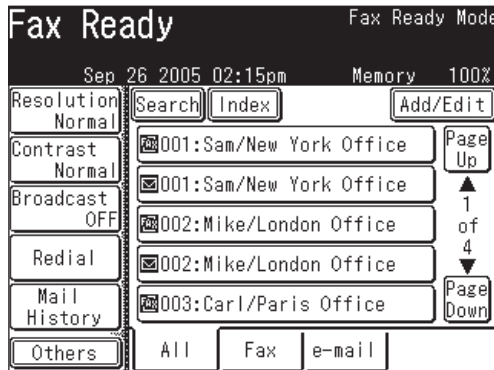

(When "All" tab is selected)

- (2) Press [Page Up] or [Page Down] to display the specified destination.
- (3) Press the desired destination.

Alternatives

- 1 Set the document.
- 2 Press [FAX] to display the Fax standby mode.
- 3 Adjust the document resolution and contrast, if necessary.
- 4 Press [Others].
- 5 Press [Address Book].

NOTE: You can assign [Address Book] to the soft key. See "Soft keys" on page 10-2.

- 6 (1) Use [▲] [▼] or the numeric keys to enter the address book number (001 to 300).

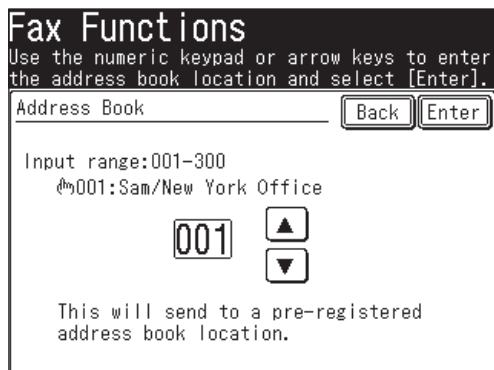

Fax Functions
Use the numeric keypad or arrow keys to enter the address book location and select [Enter].

Address Book Back Enter

Input range:001-300
☎001:Sam/New York Office

001 ▲
▼

This will send to a pre-registered address book location.

- (2) Press [Enter].

- 7 (1) Press [Fax] or [e-mail].
You can select both [Fax] and [e-mail].

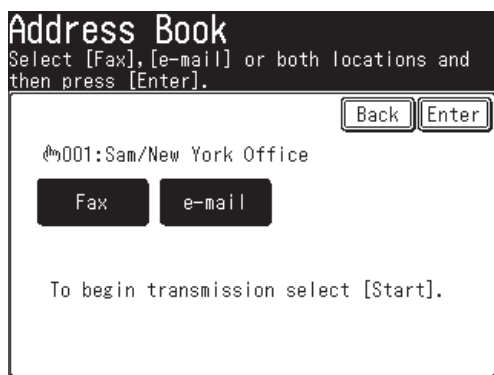

Address Book
Select [Fax], [e-mail] or both locations and then press [Enter].

☎001:Sam/New York Office Back Enter

Fax e-mail

To begin transmission select [Start].

- (2) Press [Enter] twice.

- 8 Press [Start].

Call group dialing

If you frequently send the same fax/e-mail message to several destinations, use call group dialing. Call groups can store several destinations, so you can quickly broadcast to multiple destinations by using this feature.

Registering or editing a call group

Your machine can store up to 32 call groups.

- 1 Press [Setting], [Group].
- 2 Press [Add].



- 3 (1) Enter the group name.



The group name must be registered.

- Up to 24 characters can be entered.
- For details on character entry, see page 1-10.

- (2) Press [Enter].

- 4 (1) Press [Group Members].
- (2) Specify the destination(s) to add to the group.
 - Specify the destination(s) using the address book.
 - or –
 - Specify the address book number.

NOTE: You cannot use the numeric keys to manually enter a destination. Group members must be pre-registered into the address book before they can be added to a group.

Fax numbers and e-mail addresses can be registered into the same call group.

(3) Press [Enter].

- 5 A group information will be displayed.
- 6 To register additional call groups, press [Enter], then repeat the procedure from step 2.
Press [Reset] to exit the operation and return to the standby mode.

NOTE: • To print a list of call groups, press [Setting], [List], [Group]. Then press [Yes].
• Destinations can be added to a group during the initial registration process.
(See page 2-4.)

Deleting a call group

- 1 Press [Setting], [Group].
- 2 Press the call group you want to delete.
- 3 Press [Delete], [Yes].
If you want to exit without deleting, press [No].
- 4 To delete another call group, repeat the procedure from step 2.
Otherwise, press [Reset] to exit and return to the standby mode.

How to dial using a call group

Sending a fax or e-mail using a call group

- 1 Set the document.
- 2 Press [FAX] to display the Fax standby mode.
- 3 Adjust the document resolution and contrast, if necessary.
- 4 Press [Others], [Group Tx].

NOTE: You can assign [Group Tx] to the soft key. See “Soft keys” on page 10-2.

- 5 (1) Press the group(s) you want to send to.

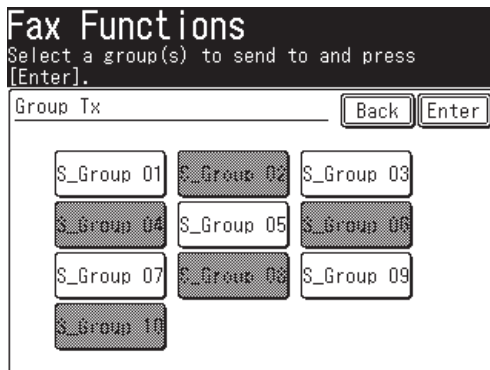

- (2) Press [Enter] twice.
 - If you want to edit the selected destination, press [Location] and edit it.
- 6 Press [Start].
 - If you want to cancel the a transmission that is in progress, use the Review Commands feature. See “Chapter 6 Reviewing or canceling commands”.

Alternative:

- 1 Set the document.
- 2 Press [FAX] to display the Fax standby mode.
- 3 Press [Index].



- 4 Press [Group].

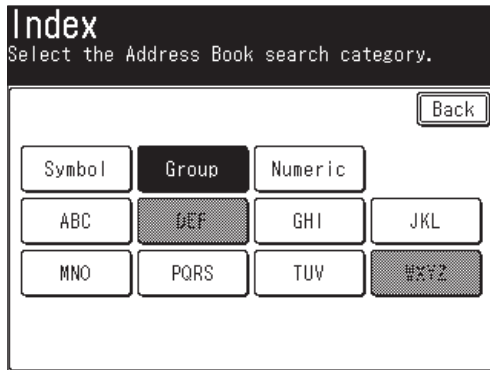

- 5 Select the call group for group transmission.

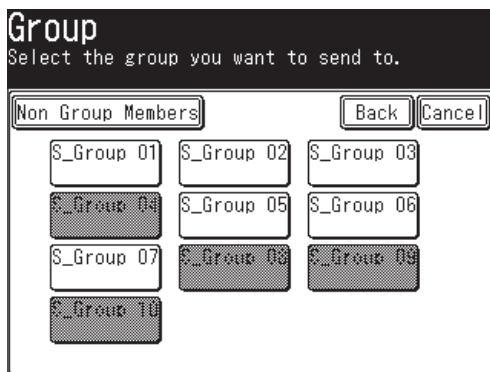

NOTE: When you press [Non Group Members], destinations not included in a call group will be displayed.

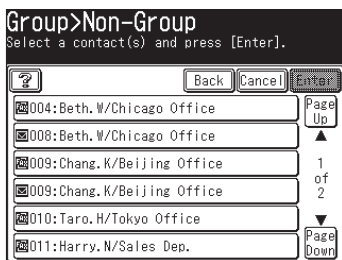

Press the destination you want to add to the group, and press [Enter].

7 Press [Start].

- If you want to cancel the a transmission that is in progress, use the Review Commands feature. See “Chapter 6 Reviewing or canceling commands” on page 6-1.

Making a phone call

Besides entering the destination directly, you can simply search the destination name registered in the address book to make a phone call. There are various searching methods, such as alpha, group or numeric.

How to dial using the address book

NOTE: When using [Monitor], press [FAX] to display to the Fax standby mode.

Connect the optional handset or an external phone to your machine to make a phone call.

- 1 Press [FAX] to display the Fax standby mode.
- 2 Lift the handset. Or press “Fax” tab, [Monitor].
- 3 Specify the destination.
 - A. Numeric keys
Press the numeric keys to enter the destination number.
 - B. Address Book-1
 - (1) Press [Address Book].
 - (2) Use the numeric keys or [▲] [▼] to enter the address book number.

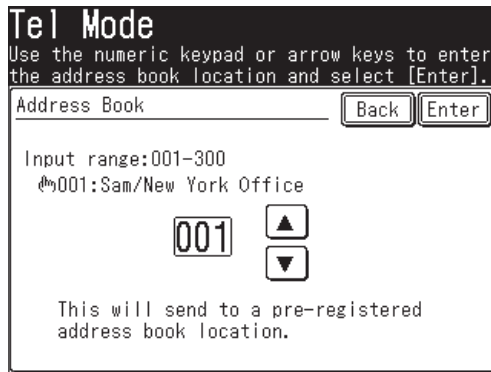

- (3) Press [Enter].

C. Address Book-2

Specify the destination using the address book.

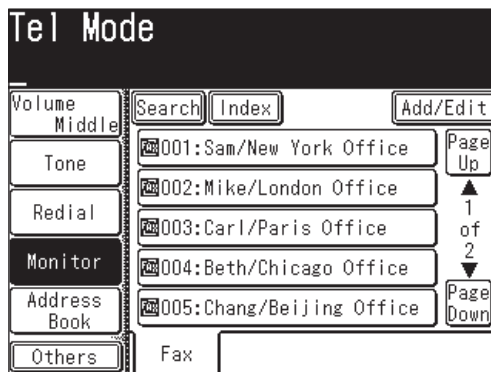

NOTE: For details on how to use the address book, see page 2-12.

If the call fails

If the call fails, the next steps will depend on the type of call it was (fax or phone).

If it was a fax call...

...Your machine will automatically redial the number. It will keep trying until one of the following occurs:

- It successfully reaches the other number.
- The maximum redial attempts has been reached.

If it was a regular phone call...

...You will have to redial manually:

- 1** Lift the handset.
- 2** Press [Redial].
- 3** Your machine can remember the last 10 dialed numbers. Select the number you want to call.
- 4** Press [Start].

How to receive a phone call

- 1** Lift the handset when the machine rings.

NOTE: You can receive a call with the machine's handset even if the power has been turned OFF.

- 2** Answer the phone.

Adjusting the optional handset volume

The small switches on the side of your machine's handset adjusts the ringer and receiver volume.

- Ringer Volume Control.....Adjust the ringer volume to one of three settings : High, Medium or Low.
- Receiver Volume Control....If it is hard to hear the remote person's voice, adjust the receiver volume to one of three settings : High, Medium, or Low.

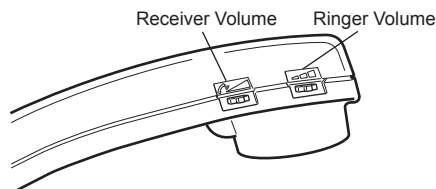

Adjusting the speaker volume

- 1 Press [FAX] to display the Fax standby mode.
- 2 Press “Fax” tab.
- 3 Press [Monitor].

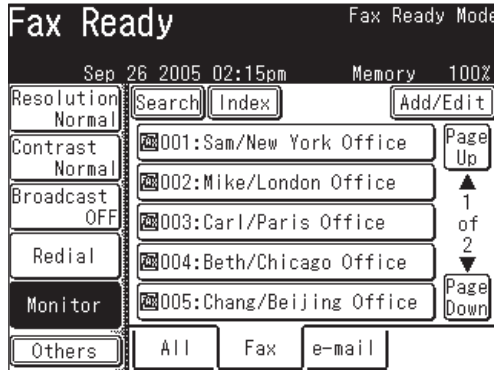

- 4 Press [Volume].

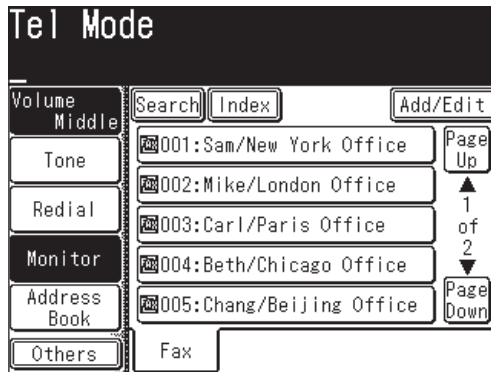

- 5 Select the desired volume and press [Enter].

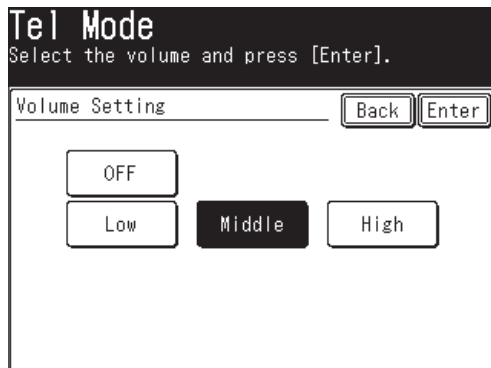

- 6 Press [Monitor] to hang up.

Chapter

3

Faxing

Before sending.....	3-2
Document handling	3-2
Scanning resolution	3-2
Scanning contrast	3-3
Sending method	3-3
Memory overflow message.....	3-4
Sending a fax.....	3-5
Memory transmission	3-5
Real-time transmission (non-memory transmission)	3-8
Manual transmission (non-memory transmission).....	3-9
Changing Document Scan in Mid Scan (Mixed Transmission) ..	3-10
Redialing.....	3-13
Automatic fax redialing	3-13
Manual redialing	3-13
Receiving a fax	3-15
Selecting the reception mode	3-15
Manual reception mode	3-15
Automatic reception mode.....	3-16
Answering calls manually.....	3-17
If paper runs out during fax reception	3-17
Settings for fax reception.....	3-20
Setting the number of rings	3-20
Print settings	3-20
Advanced fax functions.....	3-23
Broadcasting	3-24
Fax & Copy.....	3-28
Sending faxes with TTI information attached	3-30
Cover page.....	3-32
Delayed transmission	3-34
Batch transmission	3-35
Specifying the document scanning size	3-41
Polling transmission	3-42
Overseas transmission	3-43
Using an alternative telephone network service provider (Dial prefix)....	3-44
Block junk fax	3-46
Polling reception	3-50
Fax forwarding.....	3-51
Separator page.....	3-57

Before sending

Document handling

Before you begin please review the acceptable document sizes and proper setting methods on pages 1-24 to 1-25.

Scanning resolution

- **Normal** is suitable for most text documents and simple drawings.
- **Fine** is ideal for maps, moderately complicated drawings, floorplans or handwritten documents.
- **Superfine** (“S-Fine” on the display) reproduces the detail of extremely complicated drawings or line art.
- **Photo** (“Photo” on the display) captures shades in photos and drawings.

To change the scanning resolution:

- 1** Press [FAX] to display the Fax standby mode.
- 2** Press [Resolution].
- 3** Select one of the resolution types.

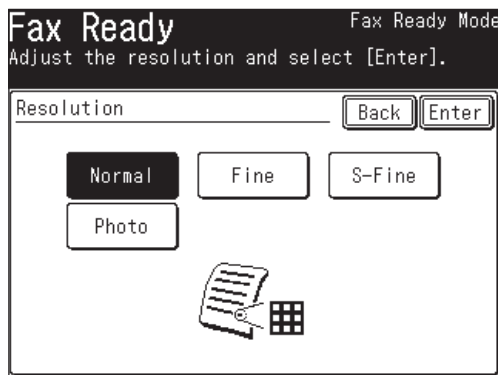

- 4** Press [Enter].

NOTE: You can change the default setting for [Resolution]. See “Accessing the default settings” on page 12-4.

Scanning contrast

Setting the scanning contrast allows you to compensate for any excessive lightness or darkness, as the case may be, of the document pages you are sending.

To change the scanning contrast:

- 1 Press [FAX] to display the Fax standby mode.
- 2 Press [Contrast].
- 3 Select one of the contrast types.

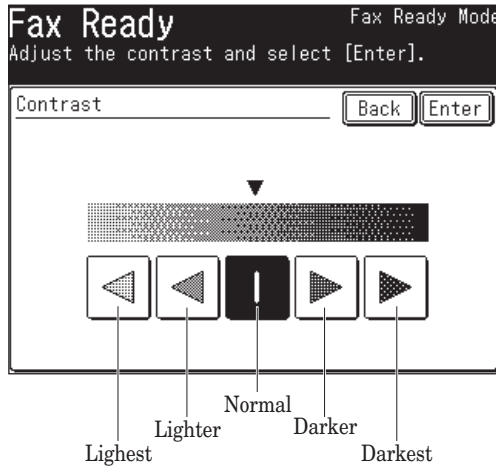

- 4 Press [Enter].

NOTE: You can change the default setting for [Contrast]. See “Accessing the default settings” on page 12-4.

Sending method

The following four sending methods are available on your machine.

Memory transmission:

For a normal memory transmission, your machine: (1) scans the entire document into memory, (2) dials the other fax machine, and (3) transmits the document.

Quick memory transmission:

For a quick memory transmission, your machine doesn't wait to scan all pages into memory before dialing. After it scans the first page of your document, your machine will dial the other fax machine. When it makes contact, your machine transmits the stored document from memory while at the same time scanning the remaining pages of your document into memory.

The quick memory transmission is defaulted to [ON]. However, you can turn the default to [OFF]. (See “Fax settings” on page 12-4.)

Real-time transmission:

In the following cases, the machine doesn't use memory for fax sending.

- When memory transmission is turned off.
- When the machine's memory is full

In Real time transmission, the next page will not scan until the current page has been transmitted.

Notes for real time transmissions:

- The document glass cannot be used for real time transmission.
- You can dial only one destination.

Manual transmission:

Use manual transmission when the other fax machine uses manual reception or when you transmit after finishing a phone conversation.

Notes for manual transmissions:

- You can dial only one destination.

Memory overflow message

In normal memory transmission, if you have stored too much information in your machine's memory, a "Memory overflow." message will appear on the display:

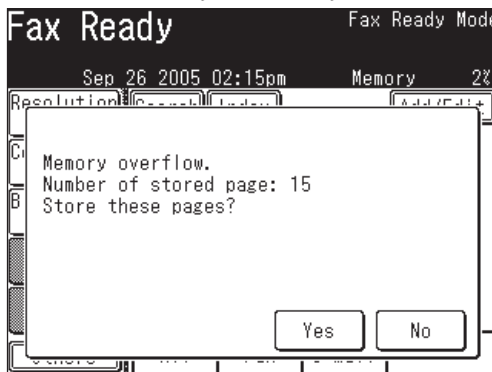

This appears because (1) too many pages have been stored in the memory, or (2) the pages that are stored have too much information on them for your machine to remember.

If this message appears, press [Yes] to tell your machine to keep as many pages in memory as possible, or press [No] to delete all pages stored during the current operation (but not previous operations).

Dividing a large document into smaller batches will help you avoid this error.

Use real time transmissions to avoid these problems. (See "Real-time transmission", page 3-8.)

NOTE: If the machine is idle for 3 minutes, the machine will automatically delete any document stored in memory during the last operation.

You can change the reset time. For details, see "Accessing the management settings" on page 12-11.

Sending a fax

Memory transmission

Sending a fax using the ADF

- 1 Set the document in the ADF. (See page 1-25 for details.)
- 2 Press [FAX] to display the Fax standby mode.
- 3 Adjust the scanning resolution and contrast, if necessary. (See page 3-2.)
- 4 Set the various functions, if necessary.
- 5 Specify the destination.

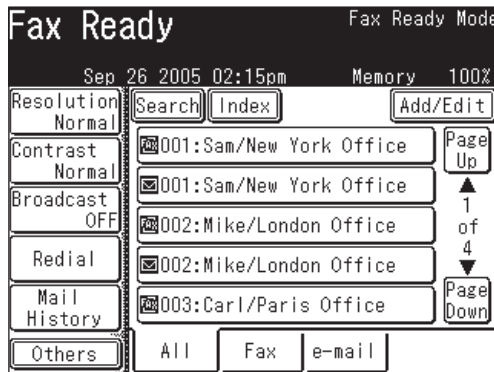

- Use the numeric keys to dial the number.
– or –
- Specify the destination using the address book. (See page 2-12.)
– or –
- When specifying multiple destinations, use broadcast transmission (See page 3-24.) or call group dialing. (See page 2-14.)

Press [Reset] to cancel the settings.

- 6 Press [Start].
(If you specify the destination using the address book, no need to press [Start].)

-
- NOTE:**
- If you want to cancel a transmission while the document is scanning, press [Stop].
If you want to cancel a transmission that is in progress, use the Review Commands feature. See “Chapter 6 Reviewing or canceling commands” on page 6-1.
 - Transmission reservation can be performed while communicating. The reserved transmission will start when the current communication is completed. Transmission can be reserved for up to 100 communications.
 - If the call fails, see “Redialing” on page 3-13.
-

Sending a fax using the document glass

- 1 Set the document on the document glass. (See page 1-25 for details.)
- 2 Press [FAX] to display the Fax standby mode.
- 3 Adjust the scanning resolution and contrast, if necessary. (See page 3-2.)
- 4 Set the various functions, if necessary.
- 5 Specify the destination.

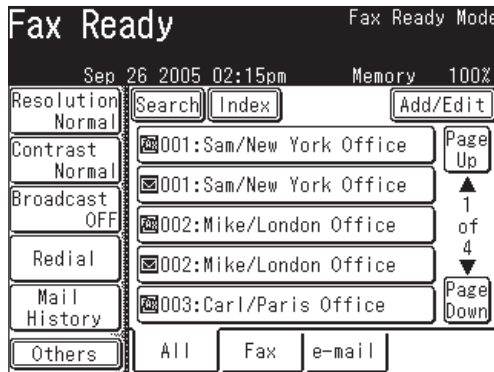

- Use the numeric keys to dial the number.
– or –
- Specify the destination using the address book. (See page 2-12.)
– or –
- When specifying multiple destinations, use broadcast transmission (See page 3-24.) or call group dialing. (See page 2-14.)

Press [Reset] to cancel the settings.

- 6 Press [Start].
(If you specify the destination using the address book, no need to press [Start].)

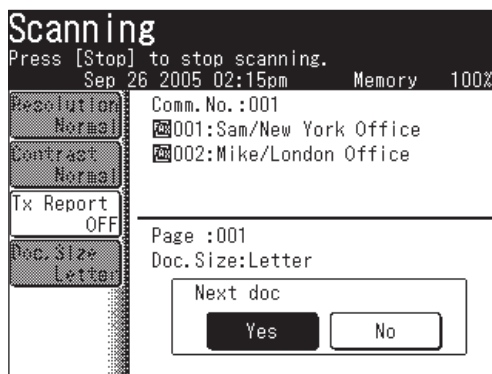

- Pressing [No] during document scanning will start the fax transmission of all documents when the scan has been completed.

- 7 When scanning has been completed, set the next document.

8 Press [Next Doc]. The scanning of the next document will begin.

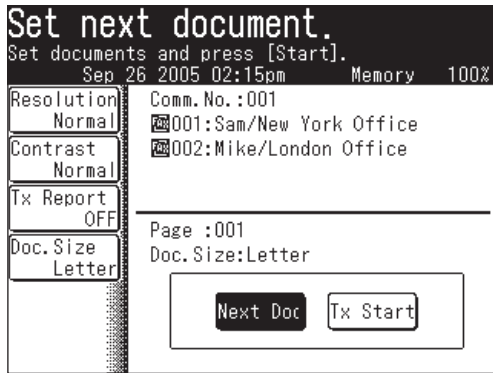

- Press [Tx Start] when all the documents have been scanned.

9 Fax transmission will start.

-
- NOTE:**
- If you want to cancel a transmission while the document is scanning, press [Stop].
If you want to cancel a transmission that is in progress, use the Review Commands feature. See “Chapter 6 Reviewing or canceling commands” on page 6-1.
 - Transmission reservation can be performed while communicating. The reserved transmission will start when the current communication is completed. Transmission can be reserved for up to 100 communications.
 - If the call fails, see “Redialing” on page 3-13.
-

Real-time transmission (non-memory transmission)

Your machine will dial the remote fax machine and once contact is made, scanning and transmitting will proceed in real-time.

- With real time transmission, you can watch each page as it is scanned and sent.

To perform a real time transmission:

- 1 Set the document in the ADF.

NOTE: The document glass cannot be used for real time transmission.

- 2 Press [FAX] to display the Fax standby mode.
- 3 Adjust the scanning resolution and contrast, if necessary. (See page 3-2.)
- 4 Press [Others], [Prev] or [Next], [Memory Tx], then press [Enter].

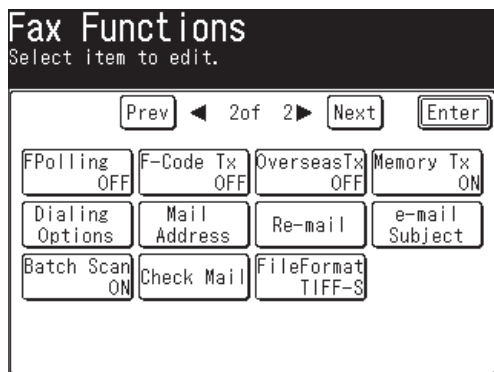

(When "All" tab is selected)

Now the memory transmission is set to [OFF].

NOTE:

- You can assign [Memory Tx] to the soft key. See "Soft keys" on page 10-2.
- You can change the default setting for [Memory Tx]. See "Accessing the default settings" on page 12-4.

- 5 Specify the destination.
 - Use the numeric keys to dial the number.
 - or –
 - Specify the destination using the address book. (See page 2-12.)Press [Reset] to cancel the settings.

NOTE: With real time transmission, you can dial only one destination. When you select multiple destinations, real time transmission will be disabled.

- 6 Press [Start].
 - To cancel the transmission, use Review commands features, see "Chapter 6 Reviewing or canceling commands".

Manual transmission (non-memory transmission)

- 1 Set the document.
- 2 Press [FAX] to display the Fax standby mode.
- 3 Press “Fax” tab.
- 4 Adjust the scanning resolution and contrast, if necessary. (See page 3-2.)
- 5 Press [Monitor].

– or –

Lift the handset if you have connected an optional handset or an external telephone to your machine.

In either case, the following display will appear:

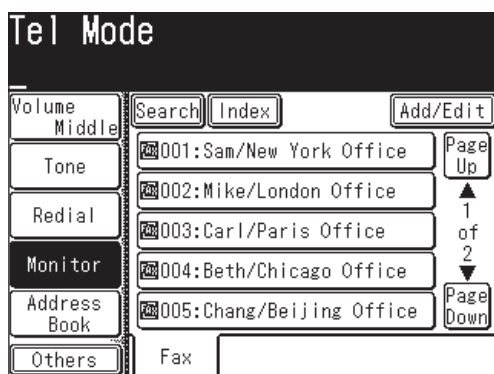

- 6 Specify the destination.
 - Use the numeric keys to dial the number.
 - or –
 - Specify the destination using the address book. (See page 2-12.)Press [Monitor] on hang up the handset to cancel the settings.

NOTE: You can dial only one destination for manual transmission.

- 7 When you hear fax tones from the remote fax machine, press [Start].

If a person answers the phone, use the handset to tell that person that you are trying to send a fax. When you hear fax tones, press [Start].

If the call fails when you use [Monitor] to dial, press [Monitor] to hang up.

If you are using the handset, hang up after pressing [Start].

 - To cancel the transmission, use the Review Commands feature. (See “Chapter 6 Reviewing or canceling commands”)

Changing Document Scan in Mid Scan (Mixed Transmission)

The document glass or the ADF can scan the document. Both scanning devices can be used in combination, such as for a cover page and map, and transmitted at the same time.

NOTE: Basics for scanning the next document

- To scan the next document, set the Next Doc setting to [Yes] while scanning the current document.
 - The ADF's default setting for Next Doc is [No]. To have the next document scanned, press [Yes] while scanning the current document.
 - For the document glass, the default setting for Next Doc is set to [Yes].
 - If you set Next Doc to [No] during scanning, the transmission will begin after scanning is completed.
-

ADF → Document glass

- 1 Set the document in the ADF.
- 2 (1) Press [FAX] to display the Fax standby mode.
(2) Specify the destination.



- Use the numeric keys to dial the number.
– or –
- Specify the destination using the address book. (See page 2-12)
– or –
- When specifying multiple destinations, use broadcast transmission (See page 3-24.) or call group dialing. (See page 2-14.)

Press [Reset] to cancel the settings.

- 3 Press [Start].

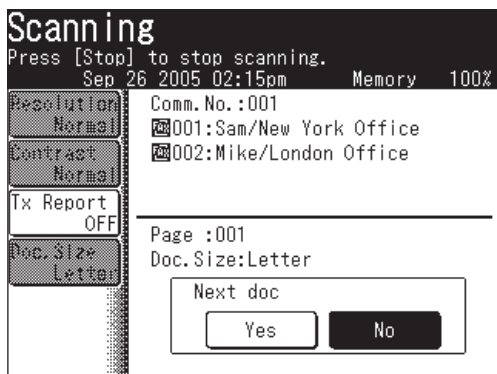

- 4 Press [Yes] while scanning the document.

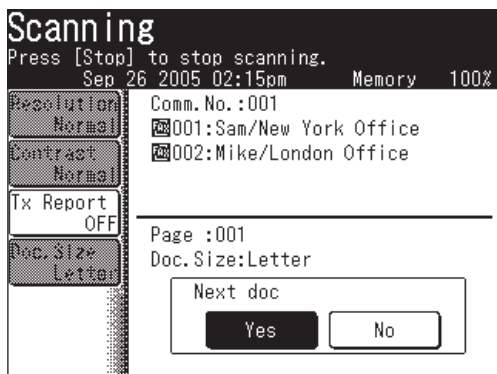

- 5 When scanning is completed, set the next document on the document glass.

- 6 Press [Next Doc]. The next document will be scanned.

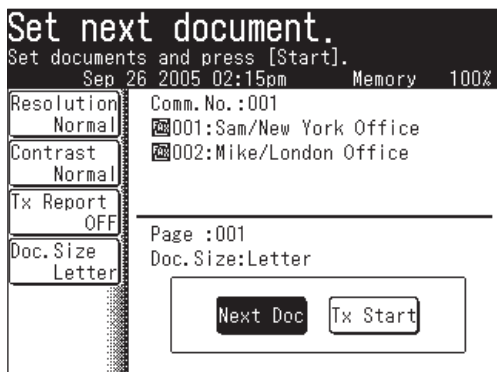

- 7 Press [Tx Start] when all the documents have been scanned.

Transmission will begin.

- Press [Stop] to cancel the scan.
- Transmission will also begin when [Start] is pressed.

Document glass → ADF

- 1 Set the document on the document glass.
- 2 (1) Press [FAX] to display the Fax standby mode.
(2) Specify the destination.

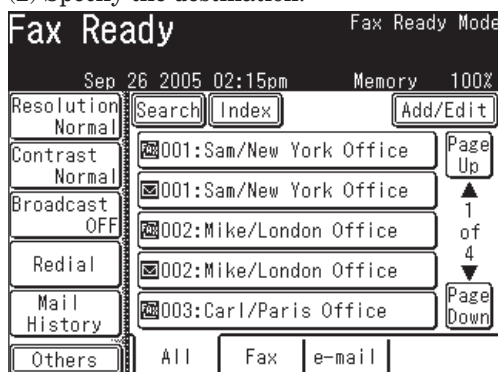

- Use the numeric keys to dial the number.
– or –
- Specify the destination using the address book. (See page 2-12)
– or –
- When specifying multiple destinations, use broadcast transmission (See page 3-24.) or call group dialing. (See page 2-14.)

Press [Reset] to cancel the settings.

- 3 Press [Start].

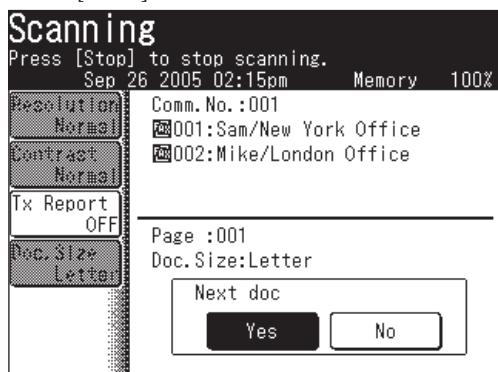

- 4 When scanning is completed, set the next document in the ADF.
- 5 Press [Next Doc]. Document scanning will begin.

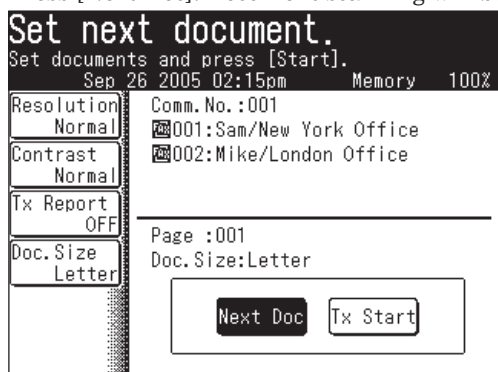

- 6 Transmission will start when scanning has been completed.
 - Press [Stop] to cancel the scan.

Redialing

Automatic fax redialing

If the transmission failed because the line was busy, “Auto Redial” will be displayed and the machine will automatically redial the number up to twice in one minute intervals .

(You can change this setting, see “Fax setting” on page 12-4.)



If the last redial attempt fails, the following message will be displayed and also the error message will automatically print. Check the message and transmit again.

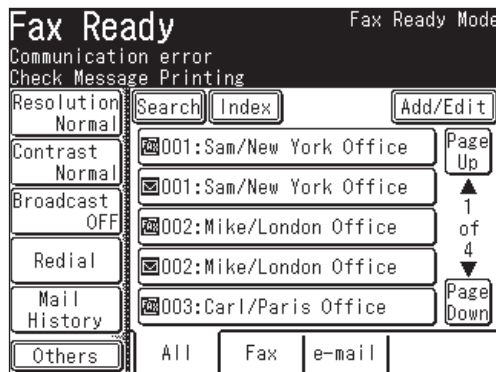

NOTE: If you want to end the redial procedures, delete the redial command of it from the command list. (See “Chapter 6 Reviewing or canceling commands”.)

Manual redialing

The last 10 numbers for fax transmissions/phone calls are kept in memory.

- 1 Set the document.
- 2 Press [FAX] to display the Fax standby mode.

3 Press [Redial].

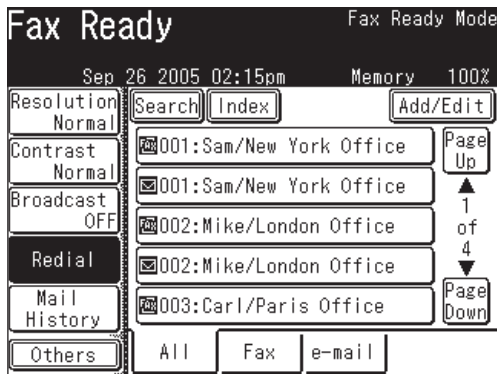

(When "All" tab is selected)

4 Select the fax number you want to redial.

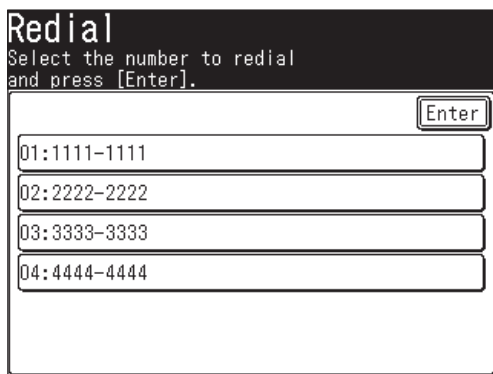

5 The selected fax number will be displayed.

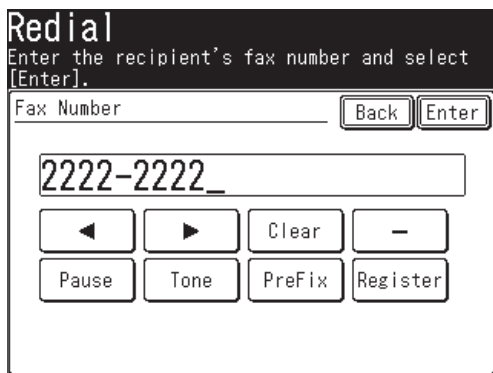

You can edit the number, if necessary.

6 Press [Enter].

7 Press [Start].

NOTE: You can register the destination in the Address Book from the display in step 5.

1 Press [Register].

2 Following the steps from step 4 in "Alternative 2: Registering or editing the fax number using the numeric keys". For details, see page 2-8.

Receiving a fax

Selecting the reception mode

- 1 Press [Setting], [User Install], [Reception Mode].
- 2 Select your desired reception mode.

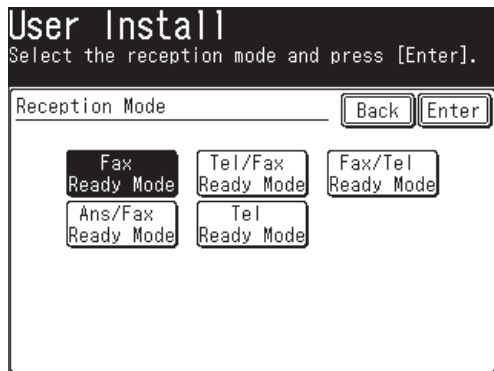

Your machine has five different reception modes:

- Fax Ready Mode (see “Automatic reception mode” on next page)
- Tel/Fax Ready Mode (see “Automatic reception mode” on next page)
- Fax/Tel Ready Mode (see “Automatic reception mode” on next page)
- Ans/Fax Ready Mode (see “Automatic reception mode” on next page)
- Tel Ready Mode (see “Manual reception mode” below)

- 3 Press [Enter] to save the setting.
- 4 Press [Reset] to exit.

Manual reception mode

Tel Ready Mode

Use it if:

- You want to use the same line for both fax and phone calls.
- You mainly receive phone calls.

In this mode:

Your machine never answers the calls automatically. You must answer each call as described in “Answering calls manually” (page 3-17).

You will need:

- An optional handset or an external phone connection.

Automatic reception mode

Fax Ready Mode

Use it if:

Your machine uses its own phone line and doesn't share it with a phone or an answering machine.

In this mode:

Your machine answers each call and attempts to receive a fax.

Tel/Fax Ready Mode

Use it if:

- You want to use the same line for both fax and phone calls.
- You are using the machine as both a fax machine and a telephone but its primary use will be as a telephone.

In this mode:

Your machine will ring the set number of times (the default setting is twice). If you don't answer the call while ringing, your machine will answer the call automatically. If a caller sends a fax, your machine will begin to receive it. If a voice call comes in, your machine will alert you with a special ring prompting you to pick up the handset. (The telephone connected to your machine will not ring.)

You will need:

- An optional handset or an external phone connection.

Fax/Tel Ready Mode

Use it if:

- You want to use the same line for both fax and phone calls.
- You are using the machine as both a fax machine and a telephone, but its primary use will be for faxing.

In this mode:

Your machine receives faxes silently but also alerts you when a regular voice call comes in. (Your machine will beep once at the end of each reception.)

When a voice call comes in, your machine will alert you with a special ring (The telephone connected to your machine will not ring). If you hear the machine ringing, pick up the handset.

You will need:

- An optional handset or an external phone connection.

Ans/Fax Ready Mode

Use it if:

You are connecting an answering machine to your machine.

In this mode:

An answering machine connected to your machine will answer each call. If a voice call comes in, the answering machine will record the incoming message.

If your machine hears a fax tone, it will begin receiving the fax message.

You will need:

- An optional handset or an external phone connection.

Using an answering machine with your machine:

- 1 Set the machine to Ans/Fax Ready Mode (See “Selecting the reception mode” on page 3-15.).
- 2 Set your answering machine to answer calls after no more than two rings.
- 3 Create a new outgoing message on your answering machine.
Your answering machine’s outgoing message should be no longer than 10 seconds.

Answering calls manually

- NOTE:**
- To answer a call manually, you must install an optional handset or an external phone to your machine.
 - Make sure there are no documents in the ADF.

Receiving a call manually with an optional handset or an external phone

In “Tel Ready Mode ” or “Tel/Fax Ready Mode”, when the optional handset or external phone rings, pick up the handset:

- When you hear the fax tones (“beep-beep-beep”), pick up the handset and press [Start]. After pressing [Start], put down the optional handset or the external phone’s handset. Press [Start] as soon as you hear the beeping sound, this will prompt the remote machine to begin transmitting.

If paper runs out during fax reception

When your machine runs out of paper, it will beep, the Alarm lamp will light and the machine will show which paper source is empty — the 1st cassette, 2nd cassette (optional) or the bypass tray.

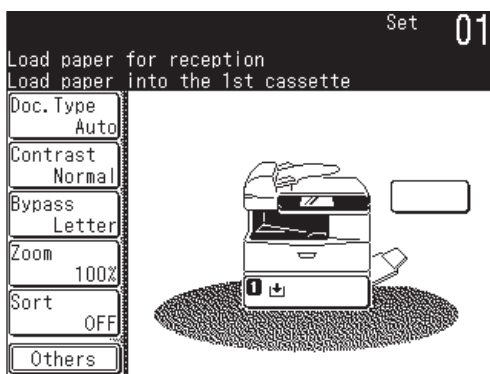

(When paper runs out in the 1st cassette)

Out-of-paper reception

If your machine runs out of paper, it can store up to 250 fax receptions in its memory. This is called “out-of-paper reception.” Once you refill the paper supply, the machine will automatically print the messages stored in memory.

NOTE: The number of pages (not receptions) your fax machine can store for out-of-paper reception will vary. It depends on:

- Your machine’s memory capacity
 - Types of documents sent to your machine
 - Fax resolution of the documents sent to your machine
-

Checking the out-of-paper reception copy print queue

The out-of-paper reception print queue status can be checked.

- 1 Press [Setting].
- 2 Press [Management].
- 3 (1) Press [Next].
(2) Press [Display Jobs in Queue].

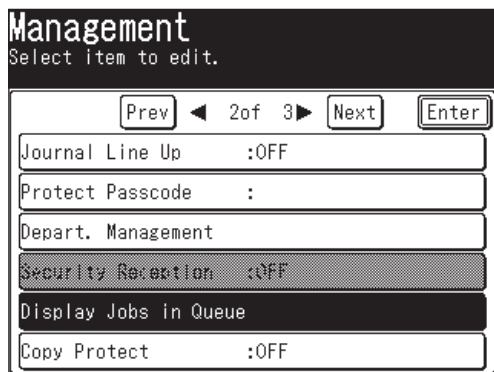

- 4 Press [FaxReceive Document].

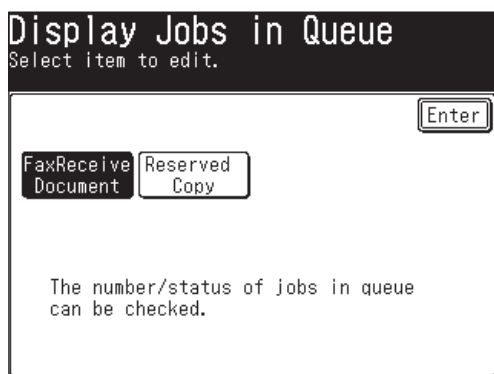

- 5 This displays the intercepted reception print queue status.

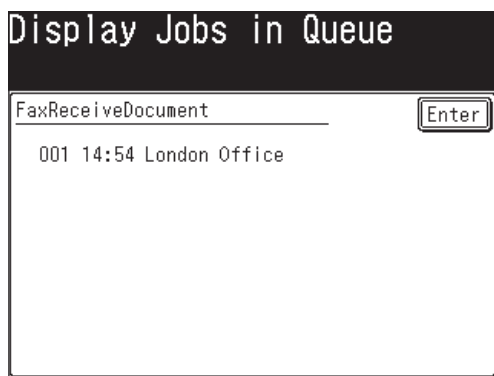

NOTE: Documents stored in memory will automatically print when printing becomes available.

Settings for fax reception

Setting the number of rings

Default setting: Twice

You can set how many times your machine will ring before answering a call. Choose from 2 to 15 rings.

- 1 Press [Setting], [Fax Settings], [Other Settings], [Redial Attempts].
- 2 Use [▲] [▼] or the numeric keys to enter the number of rings.
- 3 Press [Enter] to save the setting.
- 4 Press [Reset] to exit and return to the standby mode.

Print settings

You can set three parameters for printing received fax documents:

- Rx reduction rate
- Reduction margin
- Paper save function

All three can be set in the same procedure, mentioned on next page.

Each description is as follows:

Reception reduction rate:

Reception reduction lets you set the machine to reduce large incoming documents to a size that fits the paper in your machine. (This setting doesn't affect your machine's copying capabilities.)

Below are the options for the print reduction rate for fax reception:

Setting	Description
Auto	Automatically reduces printouts at variable rates down to a minimum of 50%. Tries to reduce printouts to fit on one sheet of the selected paper size. If it cannot reduce the document to fit on one page, the image will print at 100% size on two or more pages.
100%	Does not reduce documents. (Due to the sender's TTI, this may print two pages when receiving a one-page fax document.)

Reduction margin:

Your machine's reduction margin is measured in inches (in). We will define reduction margin by explaining how it is used:

When a fax message enters your machine's memory, the machine measures the message length and compares it to **(a)** the length of your selected paper (not including the print margins) plus **(b)** the reduction margin you set. If the length of the incoming message is shorter than **(a)** plus **(b)**, your machine will print the message on one sheet.

If it is longer, your machine will print the message on two or more sheets.

An Auto reduction setting and a reduction margin setting of 1.5 in. will print most incoming faxes as single pages. Try this combination first and if it does not work select a different setting.

Paper save function:

□ Half-page reception

Half-page reception can conserve paper if some of the faxes you receive are half-page, “Memo-sized” messages. When activated, this feature tells the machine to combine two of these half-page receptions onto a single sheet.

Half-page reception only combines half-page messages sent back-to-back during the same transmission. It won’t combine two half-page faxes from separate transmissions.

□ Duplex reception*

Duplex reception can save paper by duplexing received faxes.

When activated, this feature tells the machine to combine and print inbound documents two-up.

*The duplex printing unit is required.

To adjust the print settings

- 1 Press [Setting], [Fax Settings], [Other Settings], [Next].

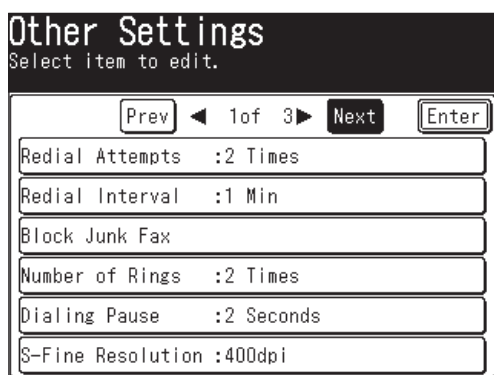

□ When you set the reception reduction rate

Default setting: Auto

- 2 Press [Rx Reduction Rate].
- 3 Select the reduction rate.

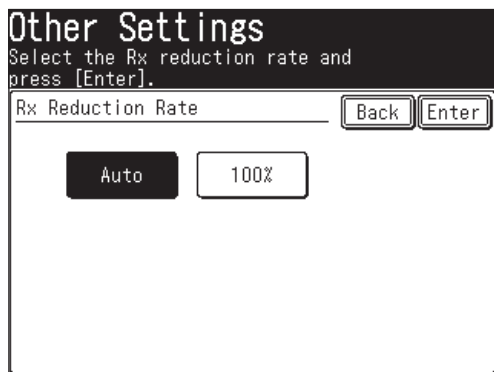

- 4 Press [Enter].

□ When you set the reduction margin

Default setting: 1.5 in.

2 Press [Reduction Margin].

3 Use [▲] [▼] or the numeric keys to enter the reduction margin.

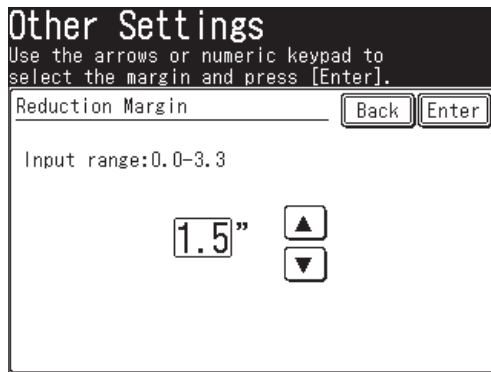

4 Press [Enter].

□ When you set the paper save function

Default setting: OFF

2 Press [Paper Saving].

3 Select the paper save function.

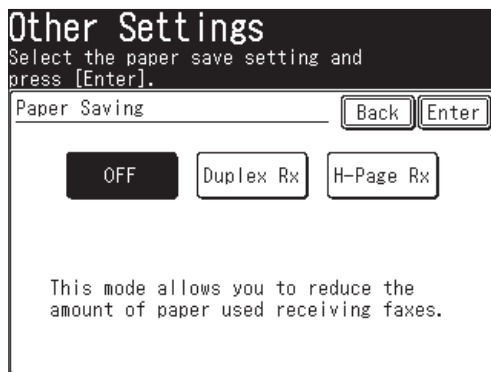

*The duplex printing unit is required to use the [Duplex Rx] function.

4 Press [Enter].

5 Press [Reset] to return to the standby mode.

Advanced fax functions

The table below lists the advanced functions that can be used in the Fax mode.

To select the advanced fax functions:

- 1 Press [FAX] to display the Fax standby mode.
- 2 Press [Others].
- 3 Press [Prev] or [Next] and select the desired function.
See the pages indicated for detailed information.

NOTE: You can assign a function that you frequently use to a soft key for instant recall. (See page 10-2.)

Advanced function	Descriptions	Reference
Broadcast	Use this to send a fax to multiple destinations.	p. 3-24
Redial	Specify the destination to resend a fax.	p. 3-13
Monitor	Obtains a dial tone for on-hook dialing.	p. 2-19
Address Book	Use this when specifying the destination by address book number.	p. 2-1
Fax Forward	Enable or disable fax forwarding.	p. 3-51
Fax&Copy	Enable or disable Fax&Copy.	p. 3-28
Group Tx	Select the group to make a group transmission.	p. 2-14
Security Rx	Enable or disable secure reception.	p. 11-3
TTI	Enable or disable TTI sending.	p. 3-31
TTI Select	Select the TTI to use.	p. 3-30
Cover Page	Select whether or not to attach a cover page.	p. 3-32
Tx Report	Prints the transmit confirmation report for the next transmission.	p. 13-8
Delayed Tx	Use this to make a delayed transmission.	p. 3-34
Batch Tx	Stores a document for batch transmission.	p. 3-35
Scan Size	Specify the scanning size for documents.	p. 3-41
Polling	Use this for polling reception.	p. 3-50
F-Code Polling	Use this for F-code polling.	p. 10-38
F-Code Tx	Use this to make an F-code transmission.	p. 10-37
Overseas Tx	Enable or disable overseas transmission.	p. 3-43
Memory Tx	Enable or disable memory transmission.	p. 3-5
Dialing Options	Use this to enter the “N” symbol.	p. 2-3

Broadcasting

The fastest way to fax one document to many destinations is to broadcast it.

In an ordinary broadcast, you can send faxes and e-mails as you normally would, except you just add more fax numbers and e-mail addresses.

You can enter up to 330 numbers:

- Address book numbers: Up to 300 destinations
- Manually-dialed numbers: Up to 30 destinations

You can broadcast using any function that requires a fax number and e-mail address to be registered.

To perform a broadcast transmission:

- 1 Set the document.
- 2 Press [FAX] to display the Fax standby mode.
- 3 Adjust the scanning resolution and contrast, if necessary. (See page 3-2)
- 4 Press [Broadcast].

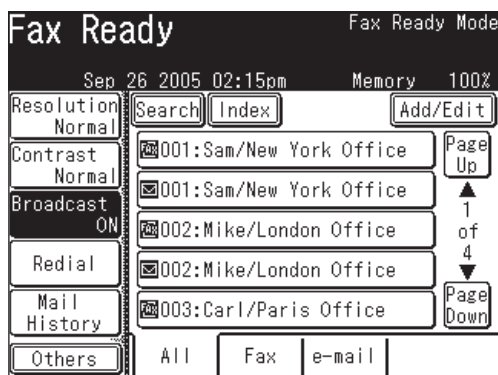

5 Specify the destination.



- Use the numeric keys to dial the number.
– or –
- Enter the e-mail address manually. (See page 4-2.)
– or –
- Specify the destination using the address book. (See page 2-12.)
– or –
- Use the call group dialing. (See page 2-14.)

NOTE: Press [Location] to review or delete the selected destinations. For details, see “Reviewing or deleting selected destinations” on next page.

6 Press [Start].

-
- NOTE:**
- To cancel the broadcast transmission, press [Fax Cancel/Job Confirm.]. (For details of fax canceling, see “Chapter 6 Reviewing or canceling commands”.)
 - If you frequently broadcast documents to the same destinations, use the call group dialing for added convenience. (See page 2-14.)
-

Reviewing or deleting selected destinations

Before pressing [Start], you can review the broadcast destinations or delete a specified destination(s).

□ Location display

[Location] is displayed when you send fax or e-mail using the following methods.

- Broadcast transmissions
- After entering fax numbers manually
- After entering e-mail addresses manually
- After selecting an address book number

Help
Displays the description of keys in the Location display.

Sort
When you press this key after selecting the sending method: [To], [Cc] and [Bcc] for e-mail address, it sorts in the order of [To], [Cc], [Bcc].

Switching key for [To], [Cc], [Bcc]
Press this key to switch the sending method from [To], [Cc], [Bcc], [To].

Location
Confirm the locations and select [Enter], or press [Start] to begin the transmission.

?	Sort	Back	Enter
To	cjones@minc.com	Page Up	▲
To	☑001:Sam/New York Office	1	▼
To	☑002:Mike/London Office	2	▼
	0123456789	Page Down	▼
	5566778899		
	☑003:Carl/Paris Office		

Delete
Press this key after selecting the destination to delete.

Specified destinations
This displays the selected destinations. The displayed order from the top is as follows:
(1) manually entered e-mail address,
(2) e-mail address ([To], [Cc], [Bcc]) specified by address book,
(3) manually entered fax number,
(4) fax number specified by address book.

- 1 Specify the destinations for the broadcast transmission, and press [Location].

Fax Ready Fax Ready Mode
 Select [Location] to confirm/delete recipient
 To: jwhite@aol.com

Resolution Normal	Search	Index	Location	Add/Edit
Contrast Normal	☑ 001:Sam/New York Office			Page Up
Broadcast ON	☑ 001:Sam/New York Office			▲ 1 of 4 ▼
Redial	☑ 002:Mike/London Office			Page Down
Mail History	☑ 002:Mike/London Office			
Others	☑ 003:Carl/Paris Office			
	All	Fax	e-mail	

- 2 The selected destinations will be displayed.

Location
 Confirm the locations and select [Enter],
 or press [Start] to begin the transmission.

?	Sort	Back	Enter
To	jwhite@aol.com		
To	☑ 001:Sam/New York Office		
To	☑ 004:Beth/Chicago Office		
	0123456789		
	☑ 002:Mike/London Office		

- 3 Follow the steps below to delete the selected destinations.
 - You can also change the sending method: [To], [Cc] and [Bcc] for e-mail addresses. (See “Location display” on page 3-26.)

- (1) Select the destination you want to delete.
You can select multiple destinations.
- (2) Press [Delete] to delete the selected destination.

Location
 Confirm the locations and select [Enter],
 or press [Start] to begin the transmission.

?	Sort	Delete	Back	Enter
To	jwhite@aol.com			
To	☑ 001:Sam/New York Office			
To	☑ 004:Beth/Chicago Office			
	0123456789			
	☑ 002:Mike/London Office			

- (3) Press [Enter].

- 4 To start the transmission, press [Start].

Fax & Copy

Documents can be faxed and copied simultaneously with just one scanning operation. This function is useful for internal communications when copies need to be made after sending a fax.

-
- NOTE:**
- If the copy protect is set to [ON], Fax&Copy cannot be used. (See page 11-22.)
 - Resolution for Fax & Copy will be either Fine or S-Fine. (No other selections are available.)
-

- 1 Set the document.
 - 2 Press [FAX] to display the Fax standby mode.
 - 3 Press [Others], [Fax&Copy].
-

NOTE: You can assign [Fax&Copy] to the soft key. See “Soft keys” on page 10-2.

- 4 Press [ON], and then [Enter].

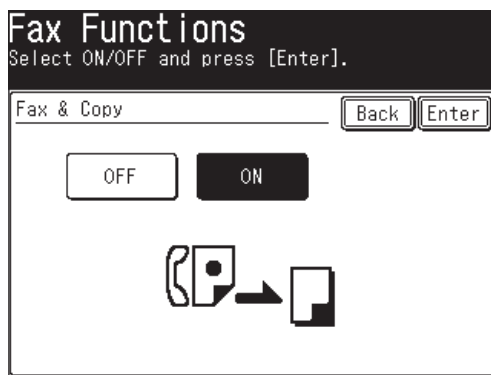

- 5 Fax&Copy is now set. Press [Enter] again.

6 Specify the destination.

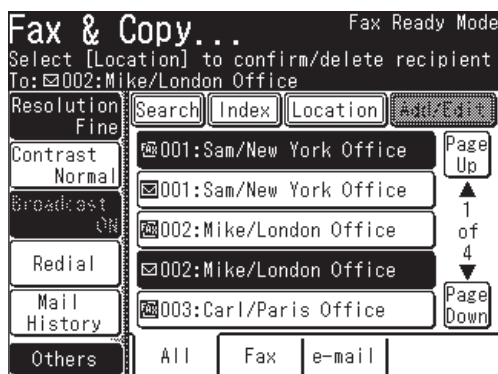

- Use the numeric keys to dial the number.
 - or –
- Enter the e-mail address manually. (See page 4-2.)
 - or –
- Specify the destination using the address book. (See page 2-12.)
 - or –
- When specifying multiple destinations, use broadcast transmission (See page 3-24.) or call group dialing. (See page 2-14.)

If you specify the destination using the address book, proceed to step 8.
If you specify it by another method, proceed to step 7.

7 Press [Start].

8 The Copy standby mode will be displayed.

NOTE: After the Copy standby mode displays, you cannot switch to the Fax standby mode (by pressing [FAX]).

9 Perform copy setting adjustments as needed.

- Press [Stop] to cancel Fax&Copy.

10 Press [Start].

Sending faxes with TTI information attached

The default setting is “TTI 1”.

Every fax and Internet fax page you send arrives at the receiving machine with a single line of text at the top of the page. This text lists your name, fax number, date & time of transmission and page number as shown below.

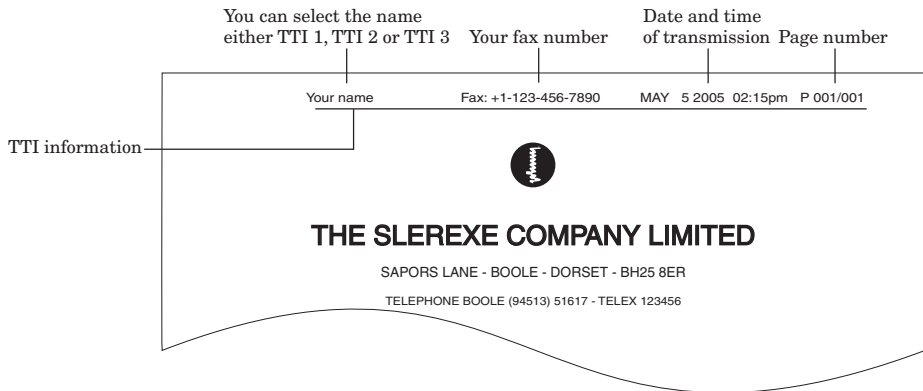

You can select the three types of TTI (your name) stored in the “Specifying the initial settings” (See pages 1-16 to 1-22) for each transmission. Also, you can tell the machine whether or not to send the TTI information (See page 3-31).

IMPORTANT: In some countries you are required by law to indicate your name and fax number on every fax you send.

Selecting TTI

NOTE: Register the TTI in advance. For details on registering the TTI, see page 1-20.

- 1 Press [FAX] to display the Fax standby mode.
- 2 Press [Others], [TTI Select].
- 3 (1) Select the TTI.

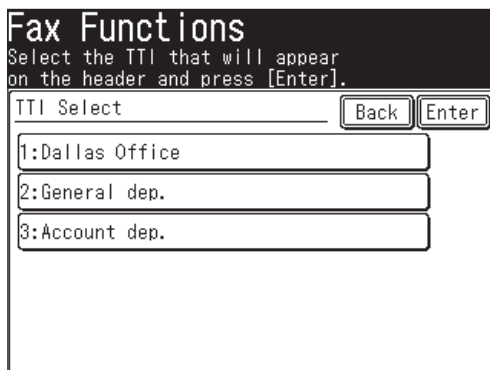

- “**TTI 1:** (your entered name)” — The machine will send TTI 1.
- “**TTI 2:** (your entered name)” — The machine will send TTI 2.
- “**TTI 3:** (your entered name)” — The machine will send TTI 3.

(2) Press [Enter] to save the setting.

NOTE: You can assign [TTI Select] to the soft key. See “Soft keys” on page 10-2.

Sending faxes with TTI information attached

- 1 Press [FAX] to display to the Fax standby mode.
- 2 Press [Others].
- 3 Press [TTI].
 - [ON] and [OFF] toggle every time you press [TTI].

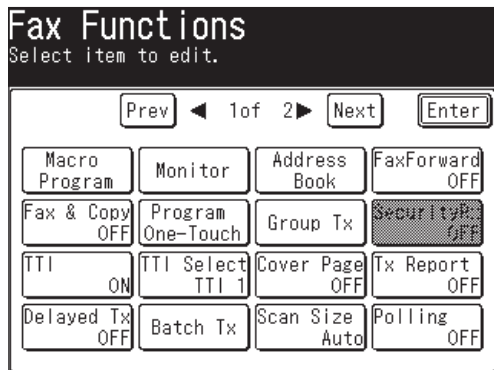

Set it to [ON] when you send a fax with TTI information.

Set it to [OFF] when you send a fax without TTI information.

NOTE: • You can assign [TTI] to the soft key. See “Soft keys” on page 10-2.
• You can change the default setting for [TTI]. See “Accessing the default settings” on page 12-4.

- 4 Press [Enter].
- 5 Specify the destination.
 - Use the numeric keys to dial the number.
 - or –
 - Enter the e-mail address manually. (See page 4-2.)
 - or –
 - Specify the destination using the address book. (See page 2-12.)
 - or –
 - When specifying multiple destinations, use broadcast transmission (See page 3-24.) or call group dialing. (See page 2-14.)

If you specify the destination using the address book, the transmission will begin.

If you specify it by another method, proceed to step 6.

- 6 Press [Start].

Cover page

Your machine can store a cover page and send it prior to each outgoing fax and Internet fax.

The default setting is OFF.

**** MESSAGE ****

[RECEIVER]*
(Destination's name)
(Destination's fax number)
(Destination's e-mail address)

[SENDER]
(Your name)
(Your fax number)
(Your e-mail address)

[MESSAGE]
(Enter your message)

* When you directly enter the destination's fax number and/or e-mail address, only the fax number or e-mail address will be printed. When you specify the destination from the address book, the name, fax number and e-mail address registered in the address book will be printed.

Turning the cover page on

- 1** Press [FAX] to display the Fax standby mode.
- 2** Press [Others].
- 3** Press [Cover Page].
 - [ON] and [OFF] toggle every time you press [Cover Page].
- 4** Press [Enter].

Now the cover page feature is working but your message line is blank. To enter a message, see "Entering the cover page message" on the next page. The usual TTI and the fax number you have entered in the Initial settings (page 1-16 to 1-22) and the e-mail address assigned to your machine will be pre-populated in the cover page automatically.

-
- NOTE:**
- For details on assigning an e-mail address to your machine, see the "Network Guide" contained in this product.
 - You can assign [Cover Page] to the soft key. See "Soft keys" on page 10-2.
 - You can change the default setting for [Cover Page]. See "Accessing the default settings" on page 12-4.
-

Entering the cover page message

Up to 120 characters can be entered for the message.

When you enter over 60 characters, the line will be automatically broken to the next line. You can also insert up to 2 additional line breaks. 1 line break is counted as 2 characters. That means the number of characters you can enter will be up to 116 when you insert 2 line breaks.

- 1 Press [Setting].
- 2 Press [Fax Settings].
- 3 Press [Cover Page].

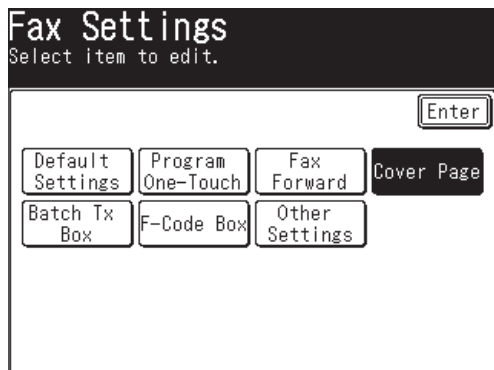

- 4 Enter the cover page message.

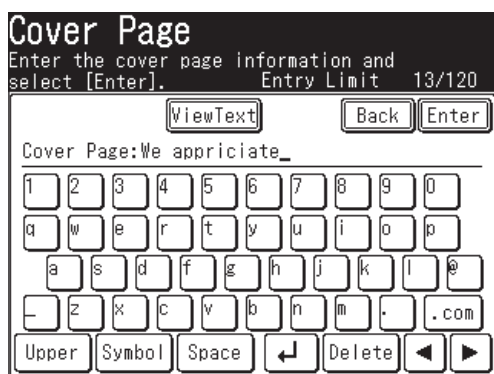

NOTE: You can check the entered text by pressing [ViewText]. You cannot edit the text in this display. To return to the text editing display, press [Enter].

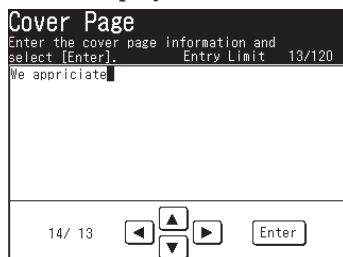

- 5 After you entered the cover page message, press [Enter].

Printing the cover page

To confirm that the cover page is set correctly, print a sample cover page from your machine. Press [Setting], [List], [Other Lists], [Cover Page], then [Yes].

Delayed transmission

Setting up a delayed transmission

Your machine can store up to 100 delayed commands, each of which you can program up to 31 days in advance.

Your machine only remembers the day of the month that it is supposed to send a delayed transmission. It does not remember the month itself. So if you want to send a transmission at 2:15 pm on 5 May, do not program the transmission sooner than 2:16 pm on 5 April.

NOTE: If a real time transmission is specified, the document will remain set until the specified time, so you will not be able to send any other faxes.

To set up a delayed transmission:

- 1 Set the document.
- 2 Press [FAX] to display the Fax standby mode.
- 3 Press [Others], [Delayed Tx].

NOTE: You can assign [Delayed Tx] to the soft key. See “Soft keys” on page 10-2.

- 4 Enter the sending day and time.

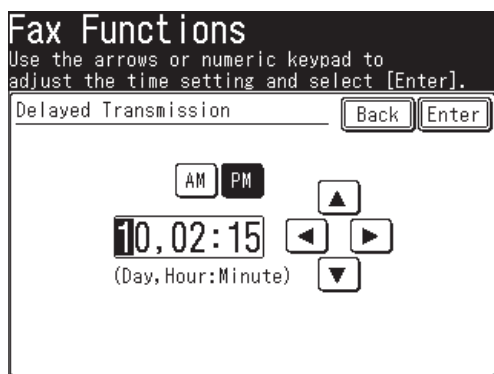

- Use [▲] [▼] [◀] [▶] or the numeric keys to enter the sending day and time.
- 5 Press [Enter] twice.
 - 6 Specify the destination.
 - Use the numeric keys to dial the number.
– or –
 - Enter the e-mail address manually. (See page 4-2.)
– or –
 - Specify the destination using the address book. (See page 2-12.)
– or –
 - When specifying multiple destinations, use broadcast transmission (See page 3-24.) or call group dialing. (See page 2-14.)
 - 7 Press [Start].

NOTE:

- To change the sending time after it has been set, you need to cancel the delayed transmission command and start over.
- To cancel the delayed command, press [Fax Cancel/Job Confirm.]. (For details of fax canceling, see “Chapter 6 Reviewing or canceling commands”.)

Batch transmission

Batch transmission allows you to store multiple documents in an electronic “basket” throughout the day and then fax that entire basket to one destination.

To do this, just tell the machine when and where the transmission should go. When that date and time arrives, your machine will transmit each document in the batch box to the remote fax machine. You can store up to 40 documents (each document can include one or more pages) into your machine’s five electronic batch boxes.

Registering a batch box

Before sending a batch transmission, you have to register batch boxes in your machine.

- 1 Press [Setting].
- 2 Press [Fax Settings], [Batch Tx Box], [Enter/Edit].
- 3 Select the batch transmission box you want to register.

The screenshot shows a screen titled "Enter/Edit" with the instruction "Select the box number to enter/edit." Below the instruction are five input fields labeled "1:", "2:", "3:", "4:", and "5:". An "Enter" button is located in the top right corner of the input area.

- 4 Specify the destination using the numeric keys or the address book. Then press [Enter].

NOTE:

- Only one destination can be set for each box.
- Press [Location] to review or delete a destination that has been specified. (See page 3-26)

- 5 Press [Tx Time].

The screenshot shows the screen after selecting box 1. The title is "1: ☎001:Sam/New York Office" and the instruction is "Select item to edit. Press [Enter] to continue." Below the instruction are three input fields: "Fax No. : ☎001:Sam/New York Office", "Tx Time : 01, 12:00am", and "Box Name:". An "Enter" button is in the top right corner.

6 Enter the sending day and time.

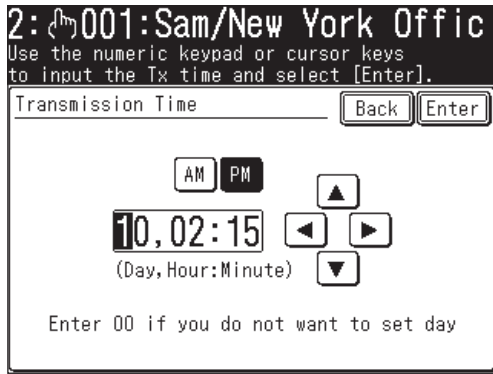

-
- NOTE:**
- Use [▲] [▼] [◀] [▶] or the numeric keys to enter the sending time.
 - Add “0” in front of one-digit numbers. (E.g.: 9 → 09)
 - Enter “00” for the day to send the stored documents at the same time every day.
-

7 Press [Enter].

8 Enter the batch box name.

(1) Press [Box Name].

-
- NOTE:**
- Up to 24 characters can be entered.
 - For details on character entry, see page 1-10.
-

(2) Enter the box name.



(3) After you entered the name, press [Enter].

9 A list of the entered information is displayed.

10 To register another batch transmission box, press [Enter], then repeat from step 3.

NOTE: The contents (settings) for batch transmission boxes that contain any documents cannot be changed.

To edit the settings of a batch transmission box you have registered....

Select the box you want to edit, and then edit the contents by overwriting or deleting the existing information in each step.

NOTE: To print a list of batch boxes, press [Setting], [List], [Other Lists], [Batch Tx Box], then [Yes]. (See page 13-3.)

Storing a document for batch transmission

Your machine can store up to 40 documents (each document can include one page or many pages). Once the batch documents are transmitted, they are automatically erased from the batch box.

NOTE: During transmission, a batch number for each document in the specified batch transmission box will be displayed. We recommend you should make a record of these batch numbers, which will control the documents and are required for reviewing and deleting documents.

To store a document in a batch box for batch transmission:

- 1 Set the document.
- 2 Press [FAX] to display the Fax standby mode.
- 3 Press [Others].
- 4 Press [Batch Tx].

NOTE: You can assign [Batch Tx] to the soft key. See “Soft keys” on page 10-2.

5 Select the batch transmission box.

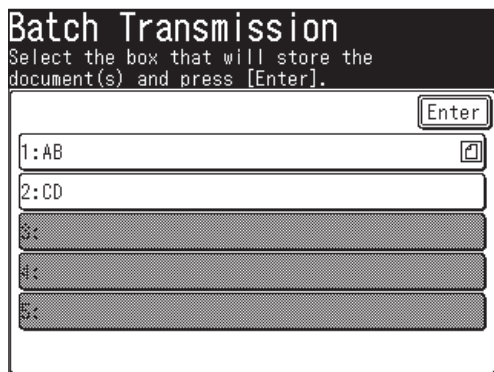

- 6 Press [Yes].

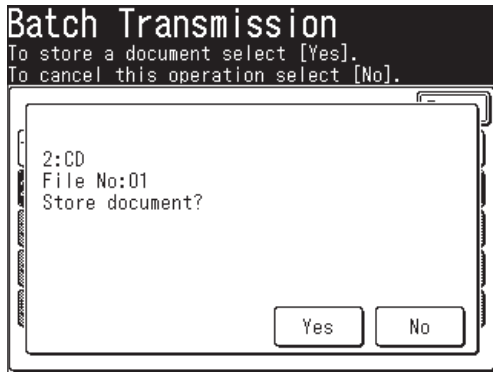

NOTE: To print a list of the documents stored in batch boxes, press [Setting], [List], [Other Lists], [Batch Tx Doc.], then [Yes].

Printing a document stored in a batch box

- 1 Press [Setting], [Store Doc Settings], [Print].
- 2 Press [Batch Tx Doc.].
- 3 Select the batch transmission box in which the documents you want to print are stored.

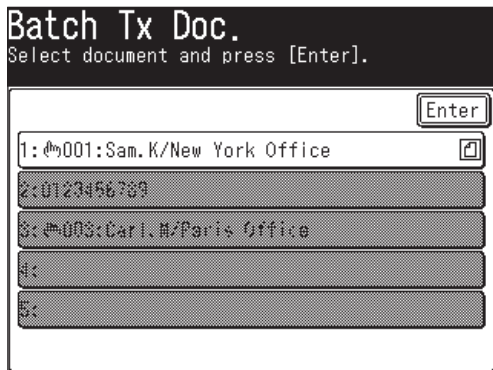

NOTE: Empty batch transmission boxes cannot be selected.

- 4 Select the file number you want to print.

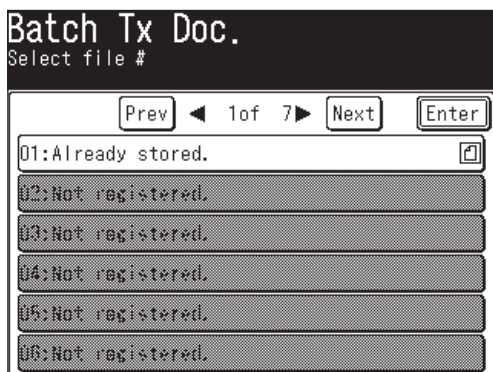

- 5 Press [Yes] to print stored document.

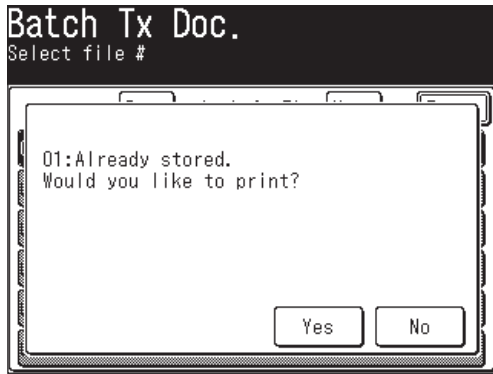

Deleting a document stored in a batch box

- 1 Press [Setting], [Stored Doc Settings], [Delete].
- 2 Press [Batch Tx Doc.].

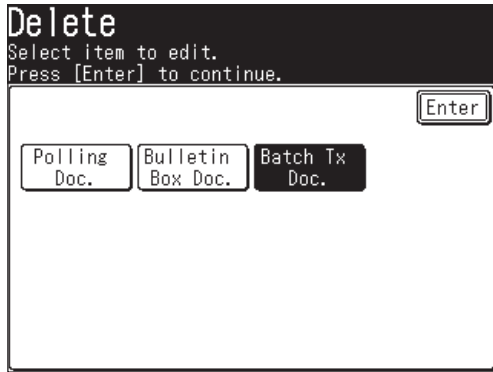

- 3 Select the batch transmission box that contains the documents you want to delete.

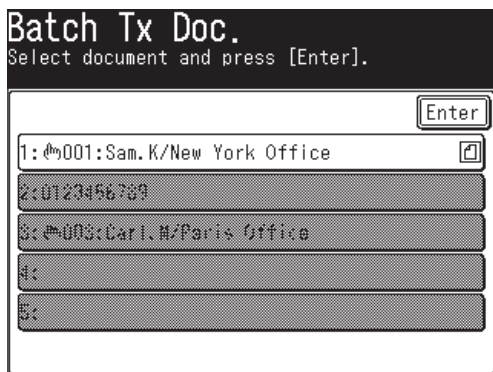

NOTE: Empty batch transmission boxes cannot be selected.

- 4 Select the file number you want to delete.

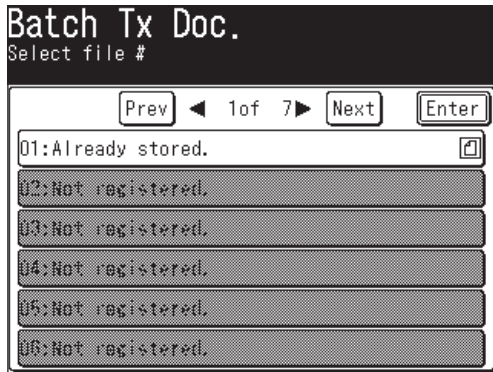

- 5 Press [Yes] to delete the stored document.



Erasing an empty batch box

Batch boxes must be empty in order to be erased. If a box has documents stored in it, you must delete those before proceeding. (See "Deleting a document stored in a batch box" on page 3-39.)

To erase an empty batch box:

- 1 Press [Setting], [Fax Settings], [Batch Tx Box], [Delete].
- 2 Press the batch transmission box you want to delete.
- 3 When the confirmation message appears, press [Yes] to delete.

Specifying the document scanning size

If the document is longer than the set width, only the scanned area will be sent.

- 1 Set the document.
- 2 Press [FAX] to display the Fax standby mode.
- 3 Press [Others], [Scan Size].

NOTE: You can assign [Scan Size] to the soft key. See “Soft keys” on page 10-2.

- 4 Select the scan size.

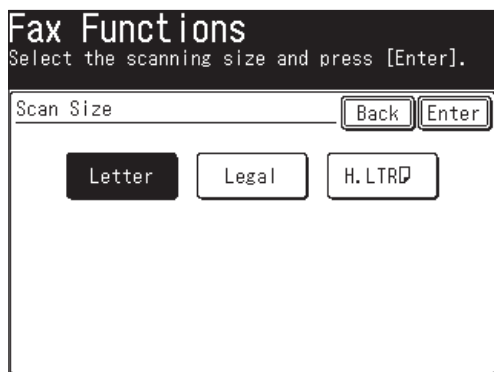

- 5 Press [Enter] twice.
- 6 Specify the destination.
 - Use the numeric keys to dial the number.
 - or –
 - Enter the e-mail address manually. (See page 4-2.)
 - or –
 - Specify the destination using the address book. (See page 2-12.)
 - or –
 - When specifying multiple destinations, use broadcast transmission (See page 3-24.) or call group dialing. (See page 2-14.)

If you specify the destination using the address book, the transmission will begin.

If you specify it by another method, proceed to step 7.

To clear this setting, press [Reset].

- 7 Press [Start].

Polling transmission

Polling transmission allows someone to retrieve a document stored in your machine's memory. The stored document will be sent when the other party calls you.

Storing a document for polling

- 1 Set the document.
- 2 Press [Setting], [Store Doc Settings].
- 3 Press [Store].



- 4 Press [Polling Doc.]



- 5 Press [Yes].

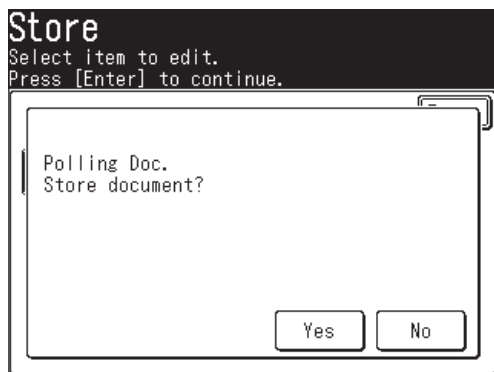

NOTE: Once the remote fax machine polls the document you stored, your machine will automatically erase the document from memory.

Printing a stored polling document

To print a polling document without deleting it, press [Setting], [Store Doc Settings], [Print], [Polling Doc.], then [Yes].

Deleting a stored polling document

To delete a polling document from your machine's memory.

- 1 Press [Setting], [Store Doc Settings], [Delete], [Polling Doc.], then [Yes].
If you want to quit the operation without deleting, press [No].

Overseas transmission

When transmitting overseas, the transmission reliability can be improved.

This function is available only when sending faxes.

- 1 Press [FAX] to display the Fax standby mode.
- 2 Press [Others].
- 3 Press [Prev] or [Next], then press [OverseasTx].
 - [ON] and [OFF] toggle every time you press [OverseasTx].

NOTE: • You can assign [OverseasTx] to the soft key. See “Soft keys” on page 10-2.
• You can change the default setting for [OverseasTx]. See “Accessing the default settings” on page 12-4.

- 4 Press [Enter].
- 5 Enter the fax number, and send the fax.

Using an alternative telephone network service provider (Dial prefix)

When you make a call, you may want to use an alternative telephone network service provider to take advantage of lower rates. You can store the access codes in the “Dial Prefix” key.

The following information describes how to program the access number.

- 1 Press [Setting].
- 2 Press [Fax Settings].
- 3 Press [Other Settings].
- 4 (1) Press [Prev].
(2) Press [PreFix].



- 5 (1) Enter the dial prefix number using the numeric keys.

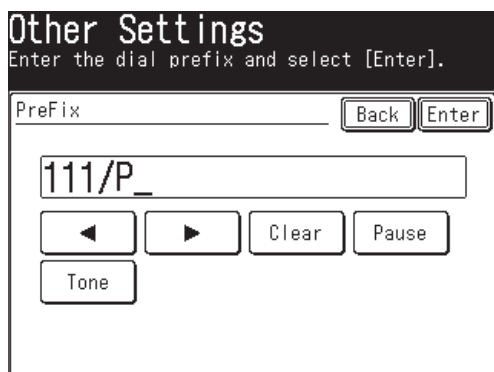

NOTE:

- You can enter numbers up to 40 digits including numbers, Pause and Tone. Note that Pause and Tone will be counted as 2 characters each.
- If you must wait for another dial tone at dialing, press [Pause] to insert a pause (/P) at the end of the access number.

- (2) Press [Enter].

- 6 Press [Reset] to return to the standby mode.

Sending faxes using the Dial prefix feature

To dial using the numeric keys

- 1** Set the document.
- 2** Press [FAX] to display the Fax standby mode.
- 3** Press [Others].
- 4** (1) Press [Prev] or [Next].
(2) Press [Dialing Options].

NOTE: You can assign [Dialing Options] to the soft key. See “Soft keys” on page 10-2.

- 5** (1) Press [PreFix], then enter the fax number using the numeric keys.

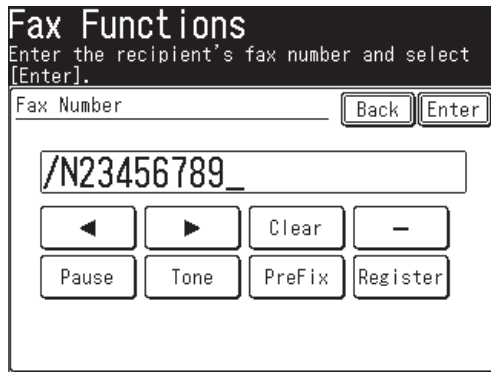

- (2) Press [Enter].

- 6** Press [Start].

Block junk fax

Your machine's Block Junk Fax feature lets you bar the gates against unauthorized incoming faxes ("Junk fax"). But before you block junk fax, first understand how this feature works, to determine if it is right for you.

There are four possible settings for Block Junk Fax:

- **Off** — The feature is not activated.
- **Mode1** — Your machine checks whether the last four digits of any phone number in your address book match the last four digits of the remote fax's phone number. If it does not find a match, your machine will disconnect the call.
- **Mode2** — This mode rejects any call from a number whose last four digits match any number in the blocked numbers list. Your machine can hold up to 50 blocked numbers.
- **Mode3** — This mode rejects numbers that are not in the address book and also rejects numbers that are in the blocked numbers list. This mode lets you keep a number on your address book for transmitting, while still blocking incoming calls by putting it on the blocked numbers list.

But before you activate the Block Junk Fax feature, please consider:

- *Not all fax machine owners enter their phone numbers on their machine.* — With Block Junk Fax activated, your machine would reject faxes from these machines.
- *Access codes can cause confusion.* — If an address book entry ends with an extra code, such as long-distance codes, Block Junk Fax will block out calls from those faxes.

To set the mode for block junk fax

1 Press [Setting], [Fax Settings], [Other Settings].

2 Press [Block Junk Fax].

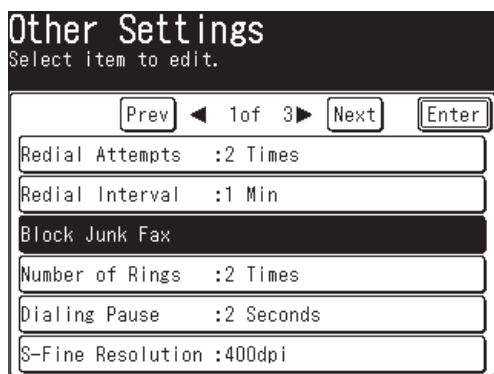

3 Press [Setting].



- 4 (1) Select the mode.

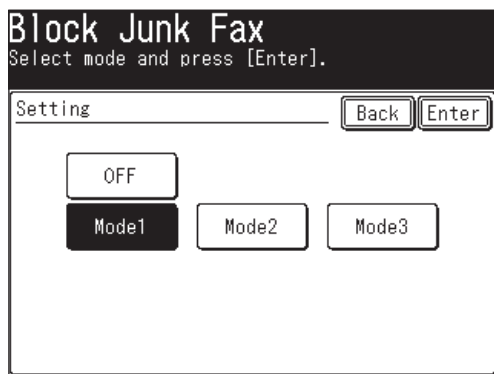

- (2) Press [Enter].

The procedure will end if you select [OFF] or [Mode 1].

If you selected either [Mode 2] or [Mode 3], proceed to step 5.

- 5 Press [Enter/Edit].

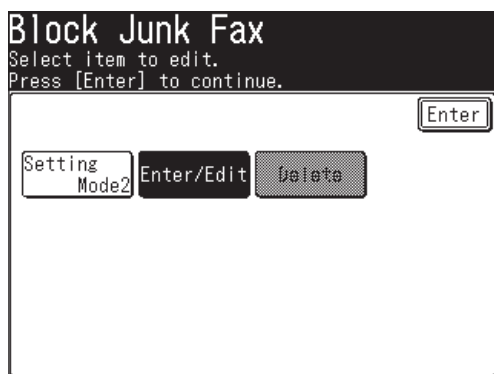

- 6 Select a box to edit.



NOTE: To change numbers already registered, select the box containing the number you want to edit.

- Using the numeric keys, enter the last four digits of the fax number you want to block. You can enter the last eight-digit number to identify each fax number, but only the last four-digit number will be used for blocked number. For example, if you want to block a fax from someone with a number of 123-456-7890, you should enter 7, 8, 9, 0:

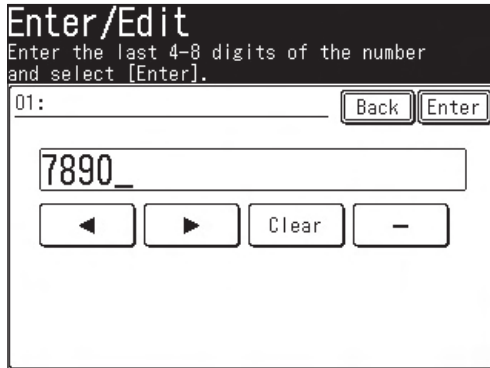

(2) Press [Enter].

- To enter another number, repeat from step 6. Press [Reset] to return to the standby mode.

Deleting a number from the blocked numbers list

To delete a number from the list:

- Press [Setting], [Fax Settings], [Other Settings], [Block Junk Fax].
- Press [Delete].

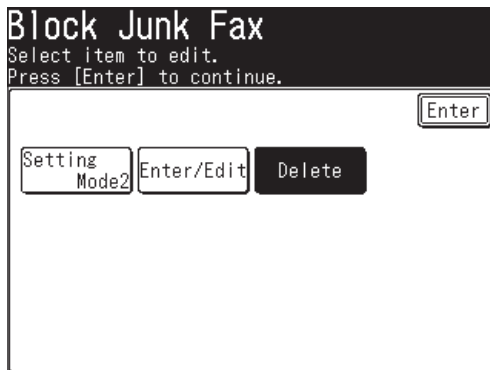

- Select the number you want to delete.

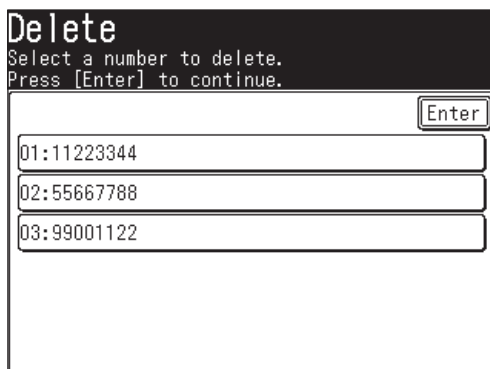

- 4 Press [Yes] to delete.



NOTE: Press [No] to return to step 3 without deleting the number.

- 5 The selected number will be deleted. To delete another number, repeat from step 3.
Press [Reset] to return to the standby mode.

Printing a list of the blocked numbers

To print a list of blocked numbers, press [Setting], [List], [Other Lists], [Block Junk Fax] then [Yes].

Polling reception

Polling allows someone to fax a document to you without having to make the call or pay for it. There are two kinds of polling:

- Regular polling — Your machine retrieves a document from a remote fax machine.
- F-Code polling — Your machine retrieves a document stored in a F-code boxes on the remote fax machine. To do this, you must be communicating with another F-code-compliant machine. For more information on F-code communication, see “F-code box feature,” on page 10-21.

NOTE: For polling to work, the remote machine must be set up to be polled.

Regular polling

To set up your machine for regular polling:

- 1** Make sure the document is loaded in the remote fax machine.
- 2** Press [FAX] to display the Fax standby mode.
- 3** Press [Others].
- 4** Press [Polling].

NOTE: You can assign [Polling] to the soft key. See “Soft keys” on page 10-2.

- 5** (1) Select [ON] to perform polling.

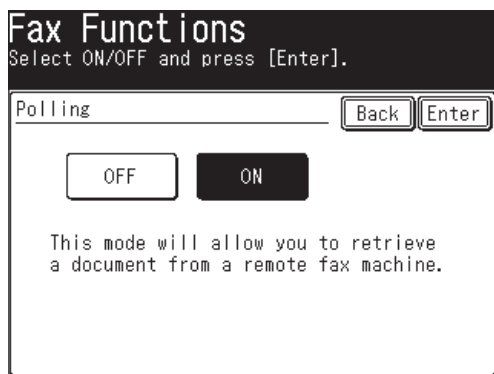

- (2) Press [Enter].

- 6** Press [Enter] to return to the standby display.
- 7** Specify the destination and press [Start].

NOTE: After pressing [Start], you can stop the communication using the Review Commands feature. (See page 6-1)

Fax forwarding

This feature tells the machine to forward the received document automatically to another destination. You can set the time period for the machine to perform this procedure.

- NOTE:**
- Fax forwarding is not compatible with polling documents.
 - Fax forwarding is not available with the “Tel Ready” reception mode.

The fax forwarding settings are different depending on your network connection.

- When your machine is connected to the network:
The fax forwarding settings must be configured using a web browser. You can configure the detailed transfer rule. From the control panel on your machine, you can toggle [ON] or [OFF] for fax forwarding when the transfer rule has been configured.
- When your machine is not connected to the network:
You can set the simply fax forwarding rule from the control panel.

The following are descriptions when the machine is not connected to the network. For details of configuring fax forwarding setting using a web browser, refer to the “Using a web browser” of the “Network Guide”.

Turning fax forwarding ON or OFF

NOTE: To turn [ON] fax forwarding, you must register at least one transfer rule.

Select [ON] in the fax forwarding setting to switch the individual transfer rules to [ON]. Faxes will be forwarded according to the registered rules.

- 1 Press [Setting], [Fax Settings], [Fax Forward], [Setting].



(When your machine is connected to the network)

- 2 (1) Select [ON] to perform fax forwarding.

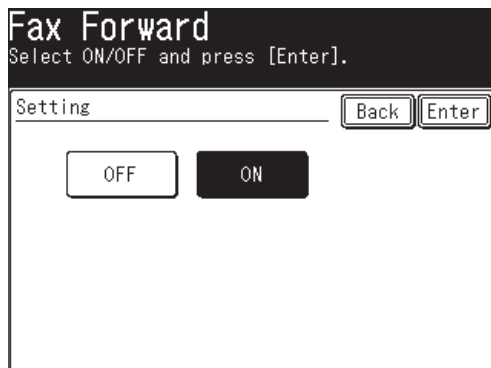

(2) Press [Enter].

- 3 Fax forwarding is now set.
Press [Reset] to return to the standby mode.

Alternative

There is another useful method to turn fax forwarding [ON] and [OFF] . This setting links to the setting for “Turning fax forwarding ON or OFF”.

NOTE: To turn fax forwarding [ON], you must register at least one transfer rule.

- 1 Press [FAX] to display the Fax standby mode.
- 2 Press [Others].
- 3 Press [FaxForward] to set the fax forwarding to [ON].

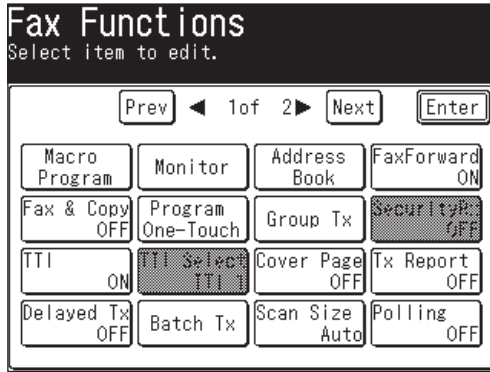

(When “All” tab is selected)

NOTE: You can assign [FaxForward] to the soft key. See “Soft keys” on page 10-2.

- 4 Fax forwarding is now set.
Press [Reset] to return to the standby mode.

Registering or editing a transfer rule

You can create up to 5 transfer rules.

NOTE: When your machine is connected to the network, you cannot register, edit or delete the transfer rules from the machines control panel. Use a web browser to register, edit or delete the transfer rules. For details on registering and editing the transfer rules using the Browser, see the “Network Guide”.

- 1 Press [Setting], [Fax Settings], [Fax Forward].
- 2 Press [Enter/Edit].



- 3 Select a number to register a forwarding rule.

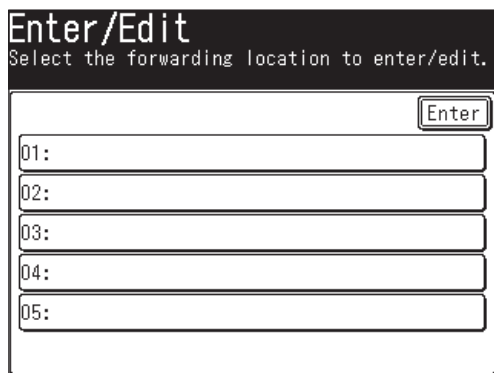

- Press [01:] when registering for the first time.
- To change a transfer rule already registered, select the number you want to edit.

- 4 (1) Enter the forwarding destination.

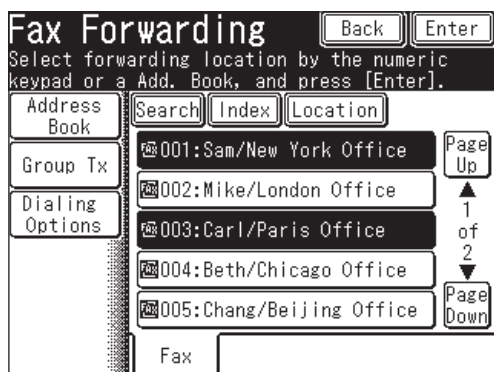

-
- NOTE:**
- You can specify using the numeric keys, the address book, the call group.
 - You can register multiple destinations. (up to 303 destinations: 300 address book numbers and 3 specified using the numeric keys)
 - Press [Location] to review or delete the specified destinations. (See page 3-26)
-

(2) Press [Enter].

□ Individual settings

5 (1) Press [Individual].

01:
Select item to edit.
Press [Enter] to continue.

Enter

Fax No. : 001, 003

Individual: ON

Time : Always

Auto Print: OFF

(2) Press [ON] to forward faxes using these transfer rules.

01:
Select ON/OFF and press [Enter].

Individual Back Enter

OFF ON

(3) Press [Enter].

NOTE: The default setting is [ON]. However, even if [ON] is selected for the individual setting, faxes will not be forwarded until the overall fax forwarding is set to [ON].

❑ Specified time

Specify the time fax forwarding is to be performed. If no time is registered, faxes will always be forwarded.

6 (1) Press [Time].

(2) Use the numeric keys to enter the time and date. Use the 12-hour format to enter the time. Press [Week day] to insert the day of the week.

(3) Press [Enter].

NOTE:

- Press [Always] to delete the specified time.
- You can also register either the day or time.

❑ Auto print

Set Auto print to [ON] if you want to print the received document before forwarding it.

7 (1) Press [Auto Print].

(2) Select [ON] if you want to print the received document in addition to forwarding it.

(3) Press [Enter].

8 After registering all the settings, press [Enter].

9 To register another transfer rule, repeat from step 3. Press [Reset] to return to the standby mode.

Deleting a transfer rule

NOTE: When your machine is connected to the network, you cannot register, edit or delete the transfer rule from the machine's control panel. Use the Browser to register, edit or delete the transfer rules. For details on registering and editing the transfer rules using the Browser, see "Network Guide".

- 1 Press [Setting], [Fax Settings], [Fax Forward], [Delete].
- 2 Select the transfer rule you want to delete.

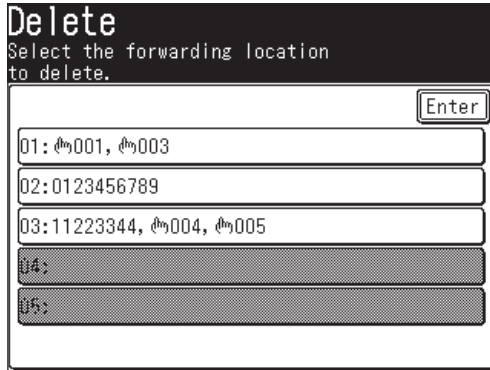

- 3 Press [Yes] to delete.



- 4 To delete another transfer rule, repeat from step 2.
Press [Reset] to return to the standby mode.

NOTE: To print a list of transfer rules, press [Setting], [List], [Other Lists], [Fax Forward], then [Yes]. (See page 13-3.)

Separator page

The separator page function can separate each received document by inserting blank paper between received fax jobs. For example, if you use the colored paper for the separator page, it is easy to identify each individual fax job.

Setting the Separator page

- 1 Press [Setting], [Paper Settings], [Separate Rx Page].

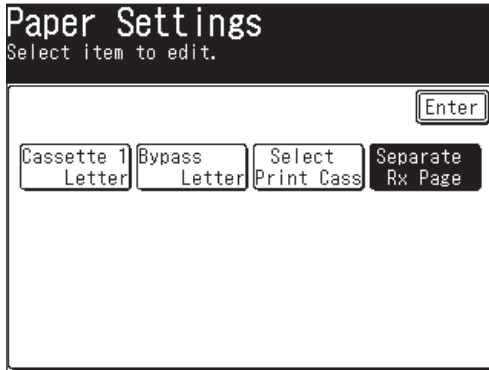

- 2 Press [Setting].

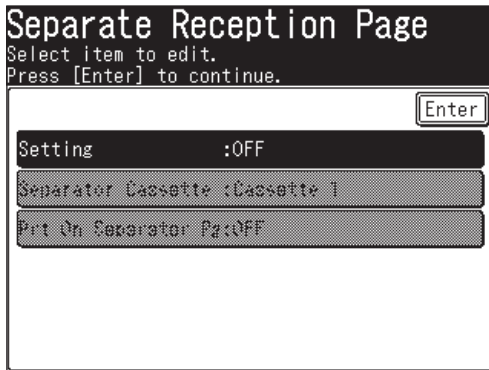

- 3 Select the mode.
To set the separator page ON, select [ON] and proceed to step 4.
To set it OFF, select [OFF] and skip to step 7.



4 Press [Enter].

5 (1) Press [Separator Cassette].

NOTE: Paper sources will only appear on the control panel if they have been installed.

(2) Select the separator page paper source.

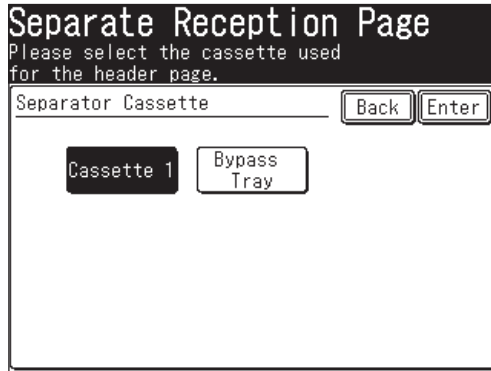

(3) Press [Enter].

6 (1) Press [Prt On Separator Pgl].

(2) Determine if the separator page will have the first page printed on it or whether it should be left blank.

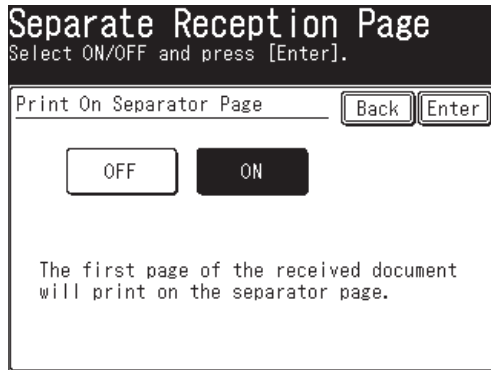

If you want the separator page to be left blank, select [OFF].

If you want to print the first page of the received document on the separator page, select [ON].

Separator page separates each received document.

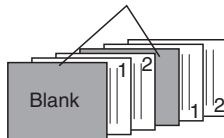

Print on the separator page: [OFF]

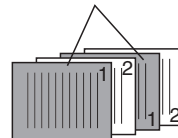

Print on the separator page: [ON]

7 Press [Enter] to save the settings.

To return to the standby mode, press [Reset].

Internet Fax functions

Before sending	4-2
Sending an e-mail	4-2
Entering an e-mail address using the QWERTY keypad	4-2
Re-mail	4-3
Mail History	4-4
Reviewing or canceling commands	4-6
Advanced mail functions	4-6
Adding a text message to your e-mail.....	4-7
Batch scanning.....	4-11
Checking for new e-mail.....	4-12
Specifying the attachment file format	4-13

Before sending

- For details on available document types and how to set documents, see “Document handling” on page 1-24 to 1-25.
- For details on scanning resolution and contrast, see “Scanning resolution” on page 3-2 and “Scanning contrast” on page 3-3.
- For details on memory overflow messages, see “Memory overflow message” on page 3-4.

Sending an e-mail

- For details on the address book, see “The address book display” on page 2-2.
- For details on registering or editing an e-mail address, see the following methods.
 - “Registering or editing a destination” on page 2-4.
 - “Alternative 1: Registering or editing directory into the address book” on page 2-7.
 - “Entering an e-mail address using the QWERTY keypad” on page 4-2.
- For details on deleting an address book number, see page 2-10 to 2-11.
- For details on dialing using the address book, see “How to dial using address book” on page 2-12.
- For details on call group dialing, see “Call group dialing” on page 2-14.

Entering an e-mail address using the QWERTY keypad

Enter the e-mail address using the QWERTY keypad.

- 1** Set the document.
- 2** Press [FAX] to display the Fax standby mode.
- 3** Adjust the scanning resolution and contrast, if necessary. (See page 3-2)
- 4** Press “e-mail” tab, [Mail Address].

- 5 (1) Enter the e-mail address using the numeric keys and/or the QWERTY keypad.



NOTE: • Up to 50 characters can be entered for each e-mail address.
• For details on character entry, see “Entering characters” on page 1-10.

(2) Press [Enter].

- 6 Press [Start].

Re-mail

Press [Re-mail] to display the last e-mail address you sent to.

- 1 Set the document.
- 2 Press [FAX] to display the Fax standby mode.
- 3 Adjust the scanning resolution and contrast, if necessary. (See page 3-2)
- 4 Press [Others], [Prev] or [Next], [Re-mail].

NOTE: You can assign [Re-mail] to the soft key. See “Soft keys” on page 10-2.

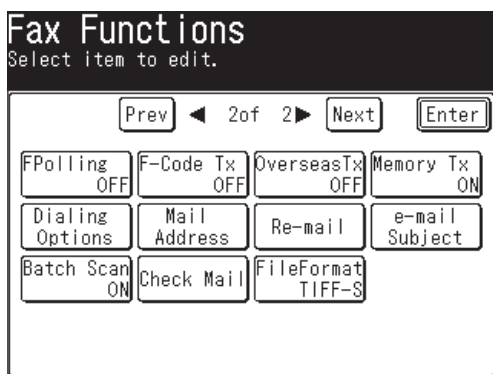

(When “All” tab is selected)

The last destination that you sent to will be displayed.

NOTE: • Press [Location] to review or delete the specified destinations.
• Press [To] to toggle between [To], [Cc] and [Bcc].

- 5 Press [Start].

Mail History

The latest 20 e-mail addresses that you manually entered and sent to will be displayed. You may select a number to send to.

*E-mail addresses will not repeat on the list, even if the address has been sent to multiple times.

- 1 Set the document.
- 2 Press [FAX] to display the Fax standby mode.
- 3 Adjust the scanning resolution and contrast, if necessary. (See page 3-2)
- 4 Press [Mail History].

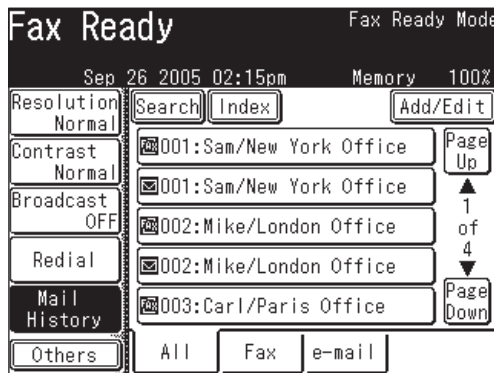

(When "All" tab is selected)

- 5 (1) Select the e-mail address you want to send to.

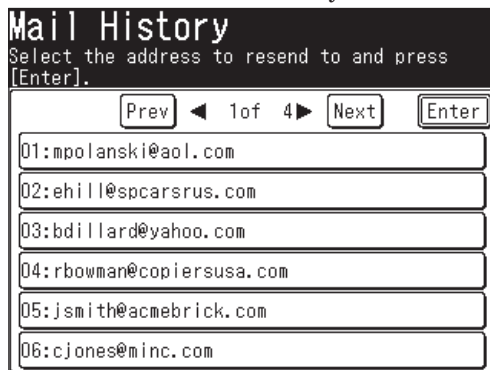

NOTE: Up to 20 e-mail addresses will be listed, with the most recent communication listed first.

The selected destination will be displayed.

The screenshot shows a screen titled "Mail Address" with the instruction "Enter the recipient's e-mail address and select [Enter]." and "Entry Limit 17/ 50". At the top right are buttons for "Register", "Back", and "Enter". Below these is a text field containing "e-mail:mpolanski@aol.com". A QWERTY keypad is displayed below the text field, with the "Delete" key highlighted. The keypad includes keys for numbers 1-0, letters q-z, symbols, space, and navigation arrows.

NOTE: After you edit the e-mail address, go to step (2). For details on character entry, see “Entering characters” on page 1-10.

(2) Press [Enter].

NOTE: Press [Location] to review or delete the entered destinations.

- Press [To] to toggle between [To], [Cc] and [Bcc].
-

6 Press [Start].

NOTE: You can register the destination in the address book from the display in step 5 (1).

- 1 Press [Register].
 - 2 Following the steps from step 6 in “Registering an e-mail address using the QWERTY keypad”. For details, see page 2-9.
-

Reviewing or canceling commands

For details on the Reviewing Commands feature, see “Chapter 6 Reviewing or canceling commands”.

Advanced mail functions

The table below lists the advanced functions that can be used in the Fax mode.

To select an advanced mail function:

- 1 Press [FAX] to display the Fax standby mode.
- 2 Press [Others].
- 3 Press [Prev] or [Next] and select the advanced function.

See the page numbers indicated for detailed information.

NOTE: If you regularly use an advanced function you can register that function as a default soft key, providing instant recall. (See page 10-2.)

Advanced function	Descriptions	Reference
Mail Address	Use this to manually enter an e-mail address.	p. 4-2
Mail History	Displays a history of manually entered e-mail addresses (up to 20).	p. 4-4
Re-mail	Displays the last e-mail address that you sent to.	p. 4-3
e-mail Subject	Add a subject line and text message to your e-mail transmission.	p. 4-7
Batch Scan	Enable or disable batch scanning.	p. 4-11
Check Mail	Check for new e-mail documents that have arrived.	p. 4-12
File Format	Select the file format of your attachment.	p. 4-13

NOTE: You can select the following functions when sending an Internet fax. (For details on the following functions, see “Advanced fax functions” on page 3-23.)

- Broadcast transmission
 - Fax&Copy
 - Security reception
 - Cover page
 - Delayed transmission
 - Address book
 - Group transmission
 - TTI select
 - Transmission report
 - Scan size
-

Adding a text message to your e-mail

When you send a document to an e-mail address, a fixed subject and text are entered automatically. However you can manually enter an e-mail subject line and text to the transmission.

Editing the subject line and text message

- 1 Set the document.
- 2 Press [FAX] to display the Fax standby mode.
- 3 Press [Others], [Prew] or [Next].
- 4 Press [e-mail Subject].

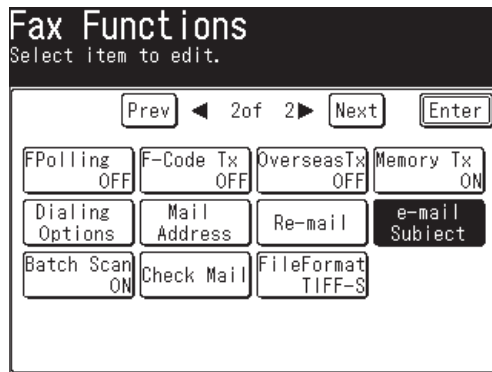

(When "All" tab is selected)

NOTE: You can assign [e-mail Subject] to the soft key. See "Soft keys" on page 10-2.

- 6 Press [Subject].

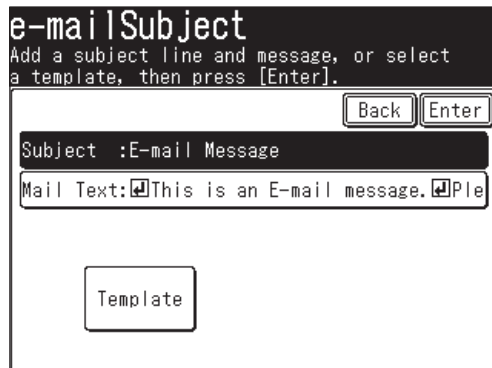

- 6 Enter the subject. The subject can contain up to 80 characters.

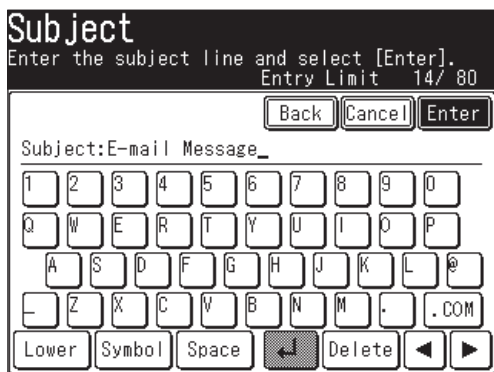

- 7 Press [Enter].

- 8 Press [Mail Text].

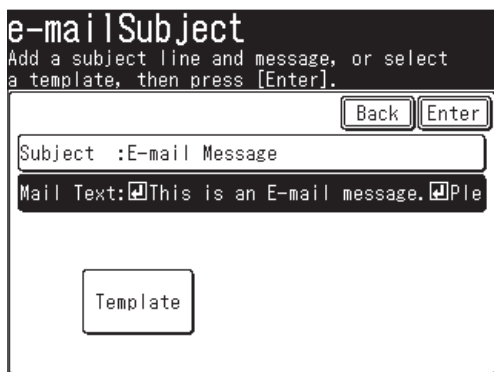

- 9 Enter the text message.

NOTE: The mail text can contain up to 1024 characters. “Return” is counted as two characters and can be used twice.

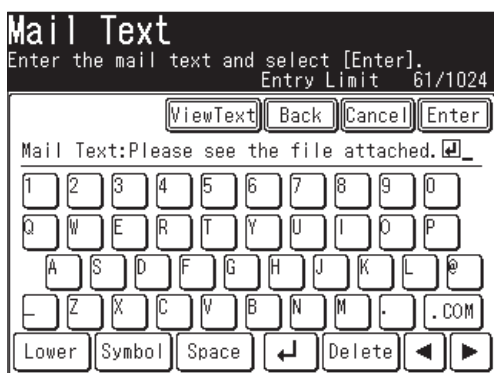

- 10 To view the entire text message, press [View Text].
Use the arrows to view all the text. Press [Enter] to close to return to the QWERTY keypad.



- 11 Press [Enter] until address book appears.
- 12 Select a destination(s).
- 13 Press [Start].

Using a registered template

You can select a registered template to simplify the entry process. You can register up to ten templates.

NOTE: The template should be registered in advance. (See the “Network Guide” for instruction.)

- 1 Set the document.
- 2 Press [FAX] to display the Fax standby mode.
- 3 Press [Others], [Prev] or [Next].
- 4 Press [e-mail Subject].
- 5 Press [Template].

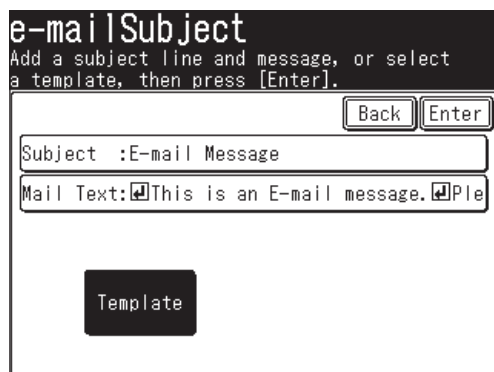

- 6** Select the desired template.
If the desired template is not shown on the display, press [Page Up] or [Page Down] to go to the next page.

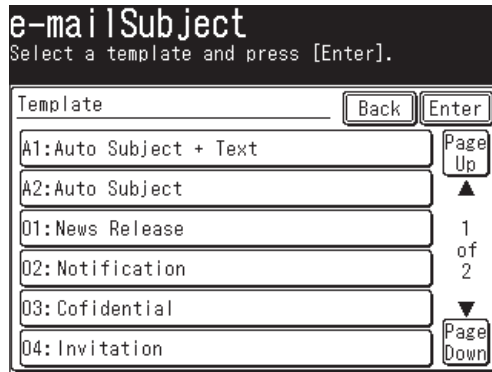

- 7** Press [Enter].
- 8** If you want to edit the subject or the text message, select either [Subject] or [Mail Text] and edit it. Refer steps 6 to 11 on page 4-8 for instructions.
- 9** Specify the destination(s).
- 10** Press [Start].

Changing the default text message

You can change the default template setting for the subject line and text message. See "Mail Settings" on page 12-9.
For details, see "Adding a text message to your e-mail" on page 4-7, 5-24.

Batch scanning

When you select [OFF], each page in the transmission will be sent as an individual file (each page will also be a separate transmission). The default setting is [ON].

NOTE: You can change the default setting for batch scan. See “Mail Settings” on page 12-9.

- 1 Set the document.
- 2 Press [FAX] to display the Fax standby mode.
- 3 Adjust the scanning resolution and contrast, if necessary. (See page 3-2)
- 4 Press [Others], [Prev] or [Next], [Batch Scan].

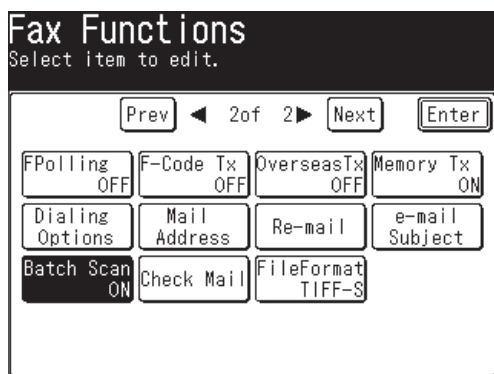

(When “All” tab is selected)

NOTE: You can assign [Batch Scan] to the soft key. See “Soft keys” on page 10-2.

- 5 (1) Press [OFF].

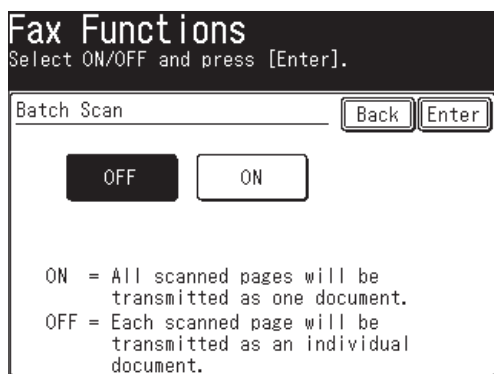

- (2) Press [Enter] twice.

- 6** Enter the e-mail address.
 You can specify it selecting an address book entry, address book number or by entering it manually.
- When specifying multiple destinations, use broadcast transmission (See page 3-24) or call group dialing (See page 2-14).

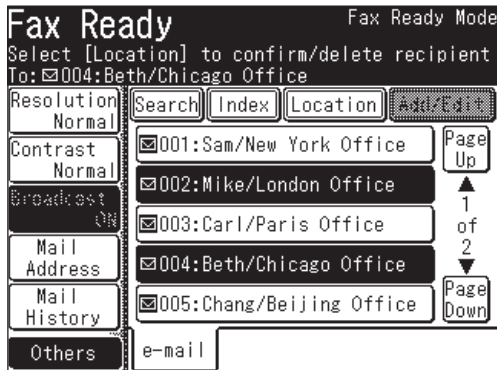

Press [Reset] to cancel the settings.

- 7** Press [Start].
 (If you specify the destination using the address book, no need to press [Start].)

Checking for new e-mail

- There are two methods for receiving internet faxes using POP, as described below.
 1. At specified time intervals
 2. Real-time
 - If you receive only a few documents each day, or you want to check the reception immediately, use the real-time method.
 - This manual describes the real-time only.
- 1** Press [FAX] to display the Fax standby mode.
 - 2** Press [Others], [Prev] or [Next], [Check Mail].

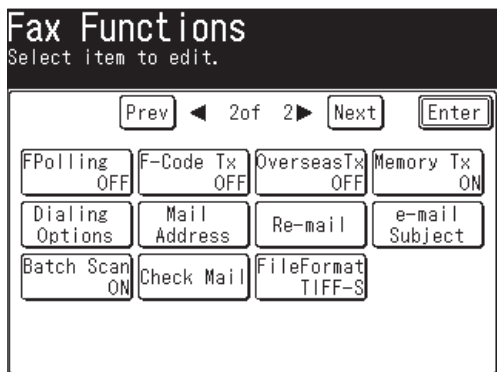

(When “All” tab is selected)

NOTE: You can assign [Check Mail] to the soft key. See “Soft keys” on page 10-2.

Specifying the attachment file format

- When sending to a PC, the scanned document will be sent as e-mail attachment file.
- Select the attachment format from the following: [TIFF-S], [TIFF] or [PDF].
- [TIFF-S] This form is for ITU-T T.37 simple mode. The scanned document is converted into A4 size at 200 dpi. Select TIFF-S when the remote Internet fax machine cannot receive a TIFF.
- [TIFF]..... This form is for ITU-T T.37 full mode. The scanned document is transmitted in its original scanned parameter. TIFF file format is the approved standard for Internet Faxing.
- [PDF]..... PDF is only available when sending to a PC.

NOTE: You can change the default setting for file format. See “Mail Settings” on page 12-9.

- 1 Set the document.
- 2 Press [FAX] to display the Fax standby mode.
- 3 Press [Others], [Prev] or [Next], [FileFormat].
- 4 (1) Select the file format.

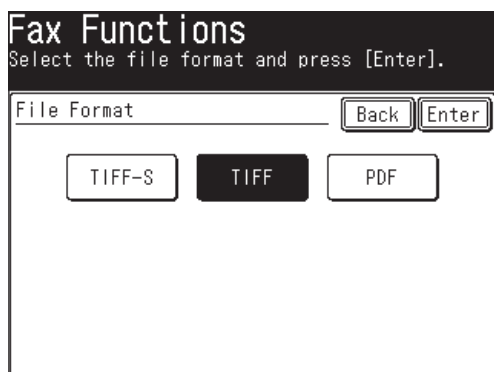

NOTE: Color scanning is not compatible with Internet faxing. For details on color scanning, see “Scan to e-mail” on page 5-9.

- (2) Press [Enter] twice.

5 Enter the e-mail address.

You can specify it using the address book or by entering it manually.

- When specifying multiple destinations, use broadcast transmission (See page 3-24.) or call group dialing. (See page 2-14.)

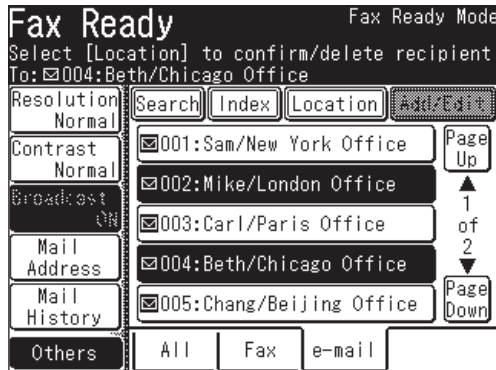

Press [Reset] to cancel the settings.

6 Press [Start].

(If you specify the destination using the address book, no need to press [Start].)

Chapter

5

Scanning

Before scanning.....	5-2
Resolution.....	5-2
Contrast.....	5-3
Document type	5-4
Scan size	5-5
Entering the file name.....	5-6
Scan to e-mail.....	5-9
Sending a document by e-mail	5-9
Selecting a destination from the Address Book	5-11
Searching for an e-mail address	5-15
Sending a document using the mail history.....	5-21
Re-mail	5-22
Reviewing or changing your selected destinations	5-23
Adding a text message to your e-mail.....	5-24
Scan to folder.....	5-28
Scanning documents into a folder.....	5-28
Scanning documents using a folder shortcut	5-33
Reviewing or canceling selected folders	5-34
Registering or editing a folder shortcut.....	5-35
Scan to FTP	5-42
Scanning documents to an FTP server	5-42
Registering an FTP server to a shortcut	5-45
Scanning documents using an FTP shortcut	5-47
Reviewing or canceling selected FTP servers	5-48
Registering or editing an FTP server shortcut	5-49
Advanced functions.....	5-56
Color	5-56
Zoom	5-57
Batch scanning.....	5-59
Selecting the file format	5-60
Duplex scanning	5-61
Broadcasting	5-63
Attaching additional files to the scanned document.....	5-64

Before scanning

You can customize your job prior to scanning.

Resolution

You can select either 200 dpi, 300 dpi or 600 dpi scan resolutions for monochrome scanning, or 100dpi, 200dpi, 300dpi or 600 dpi scan resolution for color scanning. Scanning at 600 dpi provides greater detail in scanned images, but creates large files and uses more PC and machine-based memory. Color documents scanned at 600 dpi data may not appear correctly in your application software.

- 1 Press [SCAN] on the control panel.
- 2 Press [e-mail], [Folder] or [FTP].
- 3 Press [Resolution].

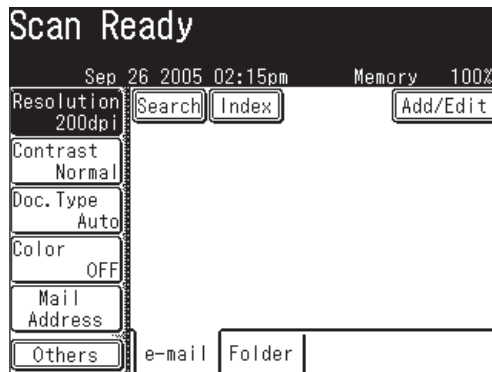

- 4 Select the desired resolution.

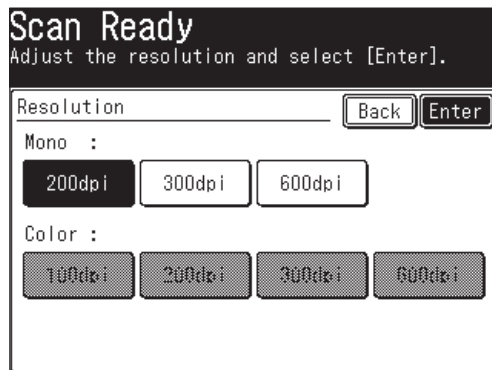

- 5 Press [Enter].

-
- NOTE:**
- When you are scanning monochrome documents, the color resolutions are grayed out. To scan a color document, first toggle [Color] to [ON], and the color resolution setting will become available.
 - You can change the default setting for [Resolution]. See “Accessing the default scan settings” on page 12-7.
-

Contrast

Adjusting the scan contrast allows you to compensate for any excessive lightness or darkness of the documents you are scanning.

NOTE: This function is not available when scanning a color document.

- 1 Press [SCAN] on the control panel.
- 2 Press [e-mail], [Folder] or [FTP].
- 3 Press [Contrast].

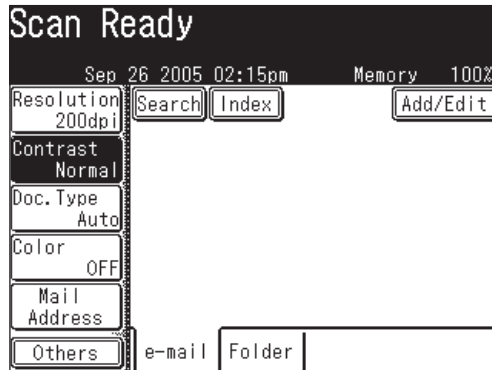

- 4 Press to left to lighten, press to right to darken.

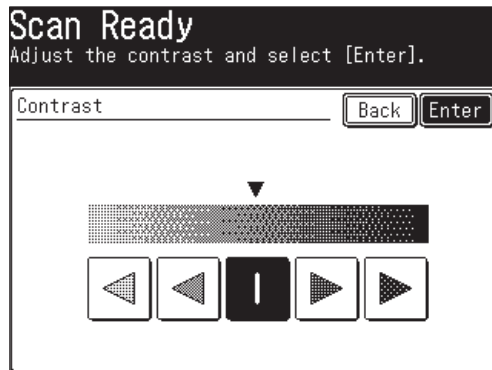

- 5 Press [Enter].

To avoid confusing the Light and Dark settings, just remember, — “Light lightens” and “Dark darkens” — to keep it straight.

NOTE: You can change the default setting for [Contrast]. See “Accessing the default scan settings” on page 12-7.

Document type

Select the document type you want to scan.

NOTE: This function is not available when scanning a color document.

Text.....Select this when scanning text documents.

AutoSelect this when scanning documents containing photographs or drawings with text.

PhotoSelect this when scanning photographs or drawings.

- 1 Press [SCAN] on the control panel.
- 2 Press [e-mail], [Folder] or [FTP].
- 3 Press [Doc. Type].

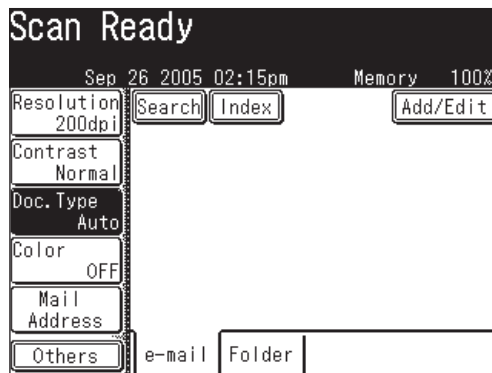

- 4 Select the desired document type.

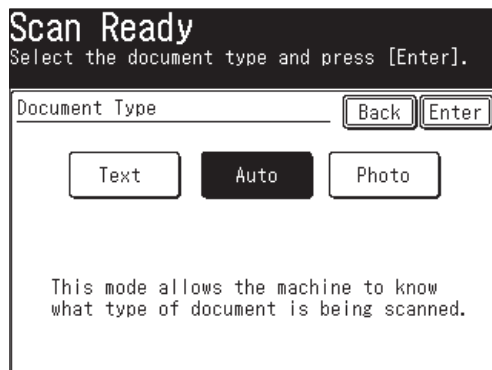

- 5 Press [Enter].

NOTE: You can change the default setting for [Doc.Type]. See “Accessing the default scan settings” on page 12-7.

Scan size

You can change the document scan size prior to scanning. The machine scans the range of the document according to the selected size. It will start scanning at the front side of the document which may eliminate or cut off the backside of the scanned document.

- 1 Press [SCAN] on the control panel.
- 2 Press [e-mail], [Folder] or [FTP].
- 3 Press [Others].
- 4 Press [Scan Size].

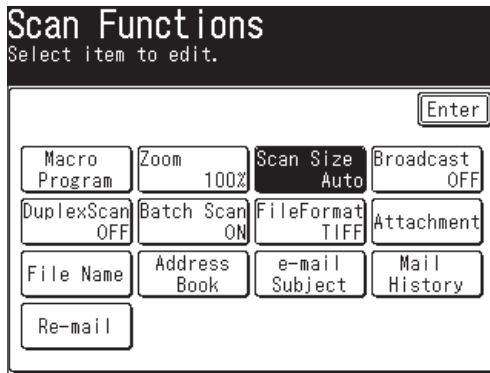

NOTE: You can assign [Scan Size] to the soft key. See “Soft keys” on page 10-4.

- 5 Select the desired scan size.

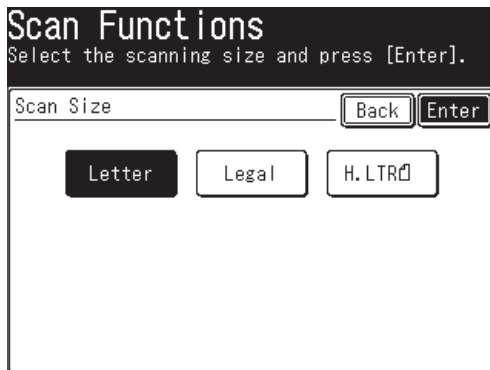

- 6 Press [Enter].

Entering the file name

You can add a file name to the document prior to scanning. The name can contain up to 20 characters. You can also register up to 10 file names in advance, allowing for quick access.

If you do not enter a file name prior to scanning, the scanned date and time will be used as the file name. For example, if the document is scanned on 26 September 2005 on 2:15 p.m.30 second, the file will be named 20050926141530. Also, if the name you use for the file already exists, the scan date and time will be added to the end of the file name to give it differentiation.

- 1 Press [SCAN] on the control panel.
- 2 Press [e-mail], [Folder] or [FTP].
- 3 Press [File Name].

If you have chosen [Folder] or [FTP], [File Name] is located on the default screen. If you have chosen [e-mail], press [Others] to locate [File Name].

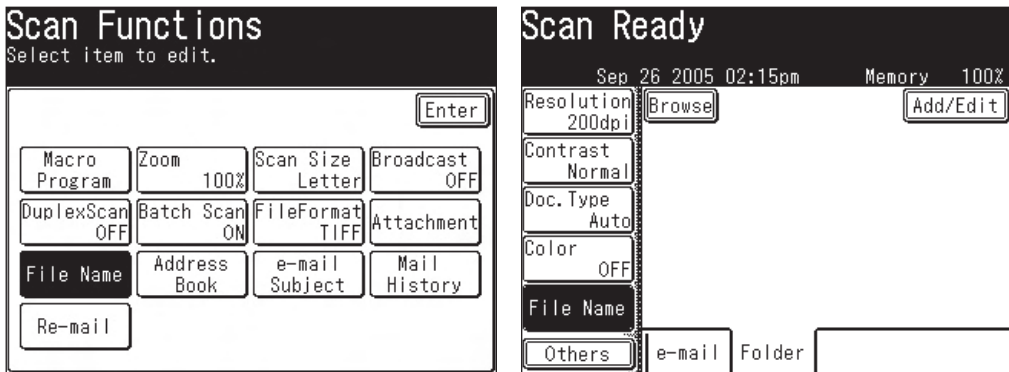

NOTE: You can assign [File Name] to the soft key. See “Soft keys” on page 10-4.

- 4 Enter the file name.

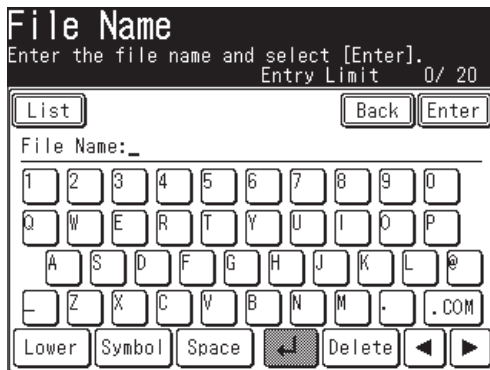

To use a pre-registered file name, proceed to step 5. Otherwise skip to step 8.

- NOTE:**
- You cannot enter a space as the first letter of the file name.
 - The characters available for the file name are alphabetical, numeral and special characters listed as below.
 - Available special characters:

	_	.	@	-	,	&	'	!	#	\$	%
))	+	;	=	[]	^	'	{	}	~

5 Press [List].

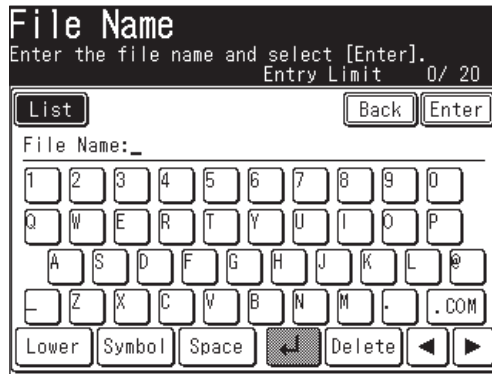

6 Select a name.

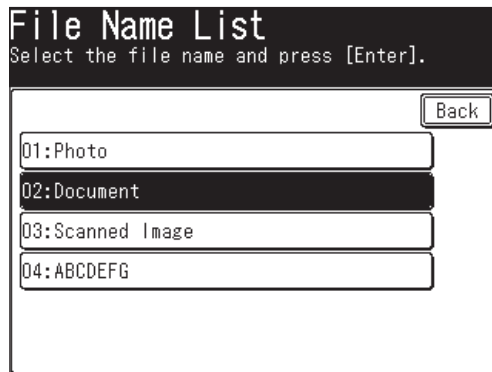

7 Edit the name, if needed.

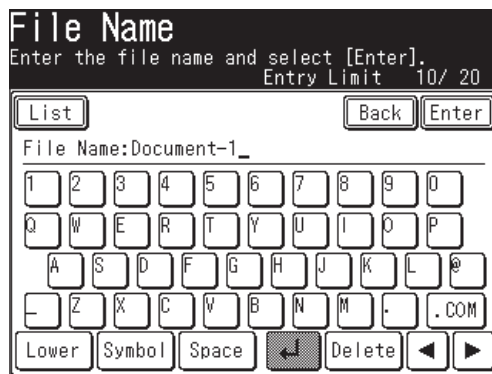

8 Press [Enter].

NOTE: To use the pre-registered file names, the names should be entered in advance. See “Registering or editing file names” next page how to register file names.

Registering or editing file names

NOTE: You can register up to 10 file names.

- 1 Press [Setting].
- 2 Press [Scanner Settings].

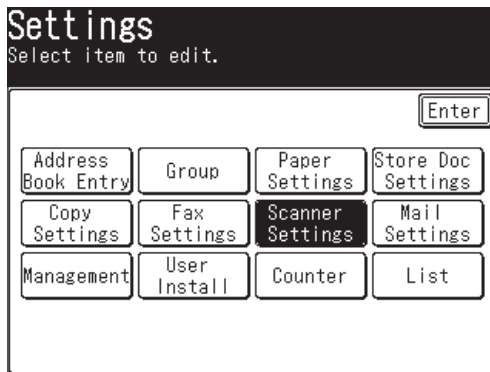

- 3 Press [File Name].
- 4 To register a new file name, select an empty key. To edit a file name, select the desired file name to edit.

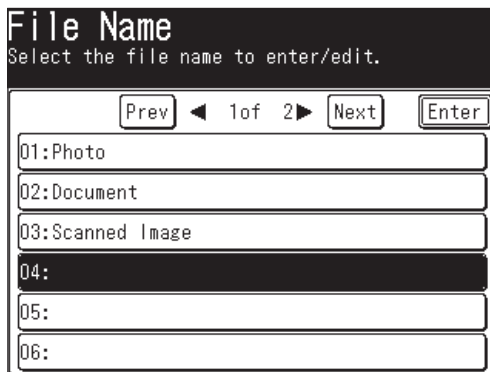

- 5 Enter or edit the file name, then press [Enter].

The name can contain up to 20 characters. Refer to page 5-6 for available characters.



- 6 To return to the Standby mode, press [Reset].

Scan to e-mail

Sending a document by e-mail

You can send a hardcopy document to an e-mail inbox.

- 1 Set the document.
- 2 Press [SCAN] on the control panel.
- 3 Press [e-mail].

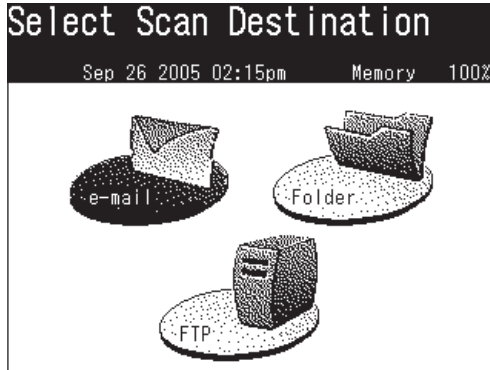

- 4 Adjust any scan settings or set any advanced functions.

For more information about those functions, see "Before scanning" on pages 5-2 to 5-8 and "Advanced functions" on pages 5-56 to 5-66.

- 5 To insert a text message into your e-mail, see pages 5-24 to 5-27.
- 6 Press [Mail Address].

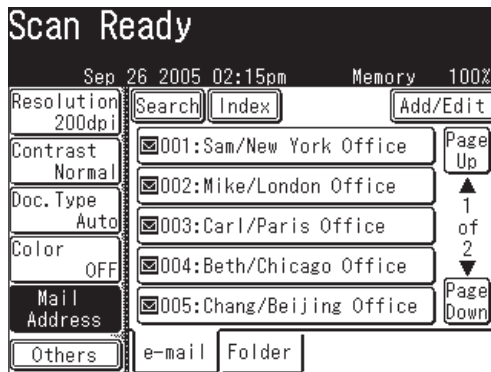

- 7 Use the QWERTY keypad or numeric keys to enter the e-mail address. The address may contain up to 50 characters.



To enter symbols, press [Symbol].

To delete a character, press [◀] [▶] to move the cursor to the character you want to delete and press [Delete].

For more information on entering characters, refer to pages 1-10 to 1-13 “Entering characters”.

There are several other ways in which to enter an e-mail address:

- Select an Address Book entry (See page 5-11 to 5-15)
- LDAP directory search (See pages 5-15 to 5-19)
- E-mail history (See pages 5-21 to 5-22)
- Re-mail (See page 5-22)

If you select a destination from the Address Book, the machine will begin scanning as soon as the destination is selected. Otherwise proceed to step 8.

If you have selected multiple destinations and would like to review them, see page 5-23. Otherwise proceed to step 8.

8 Press [Start].

Registering the entered e-mail address to the address book

If you entered an e-mail address and wish to register it into your machine-side address book, please follow these steps:

1 After you have entered the e-mail address, press [Register].



2 Select an address book entry number using [▲] [▼] or the numeric keys. You cannot select a number that has been registered.

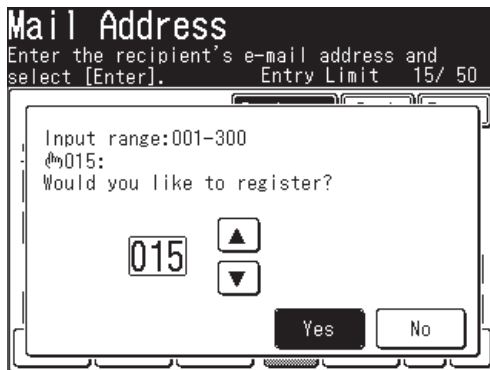

3 Press [Yes].

- 4 Enter the [Name], [Fax No] or [Group] information as needed. The [Name] field must be registered.

For more information how to enter them, see “Registering or editing an address book number” from page 2-4.

015:
Select the address book item to enter/edit.

Back Enter

Name : KEN

Fax No. : 1234567899

Group :

e-mail : ken@muratec.com

Group :

- 5 Press [Enter].

Selecting a destination from the Address Book

You can register 300 frequently used e-mail and fax numbers in advance. Once the numbers/addresses are registered, they will be displayed on the display for instant recall.

NOTE: The e-mail destination or the group information should be registered in advance. For more information, see chapter 2 “Resitering destinations in Address Book” on pages 2-4 to 2-11.

NOTE: If you select a destination from the default mode screen, the machine will automatically start scanning. If you want to select multiple destinations, press [Broadcast] prior to selecting destinations.

- 1 Set the document.
- 2 Press [SCAN] on the control panel.
- 3 Press [e-mail].
- 4 Select the desired destination(s) from the display.

Scan Ready
Select [Location] to confirm/delete recipient
To: 001:Sam. K./New York Office

Resolution 200dpi Search Index Location Add/Edit

Contrast Normal

Doc. Type Auto

Color OFF

Mail Address

Others e-mail Folder

001:Sam. K./New York Office Page Up

002:Mike. M./London Office ▲ 1 of 3

003:Carl. M./Paris Office

004:Beth. W./Chicago Office ▼

005:Chang. K./Beijing Offic Page Down

- 5 If the registered destination is not shown on the display, press [Page Up] or [Page Down] to toggle through the directory.

Go to the next section to learn how to use these functions.

Using [Index]

If you have numerous contacts registered in your address book, you may find the [Index] a useful tool in finding them.

- 1 Set the document.
- 2 Press [SCAN] on the control panel.
- 3 Press [e-mail].
- 4 Press [Index].

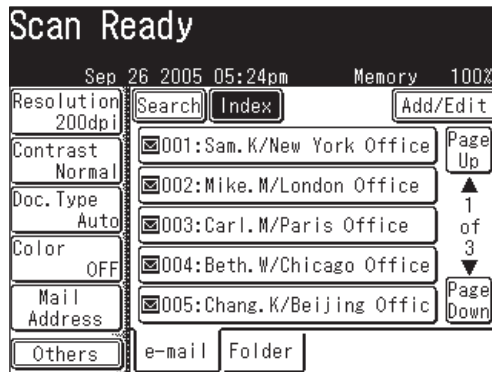

- 5 Select the corresponding button that contains the first letter of the name. If the destination begins with a symbol, select [Symbol]. To view the contacts by their Address Book number, select [Numeric].

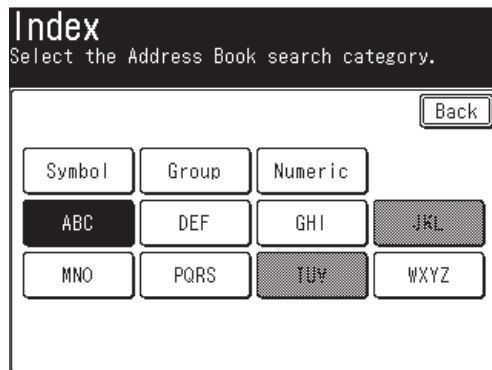

- 6 The entries will now be displayed based on your selection. If you have multiple contacts registered, use the [Page Up] and [Page Down] to toggle through the directory.

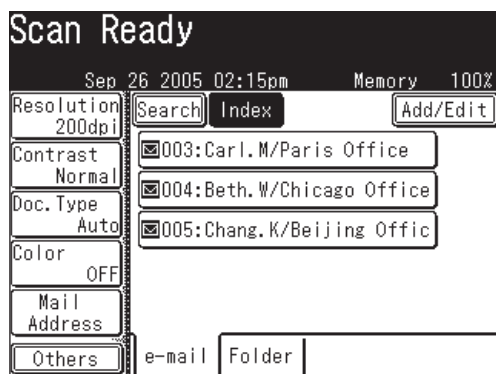

- 7 Select the desired destination(s).

Using [Group]

If you regularly send the same document to multiple parties, you can utilize the group function to automatically select these users.

- 1 Set the document.
- 2 Press [SCAN] on the control panel.
- 3 Press [e-mail].
- 4 Press [Index].
- 5 Press [Group].

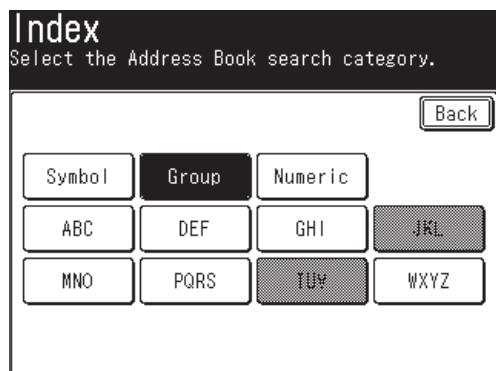

- 6 Select the desired group(s).
You can even choose [Non Group Members] to select a destination that is not associated with a group.

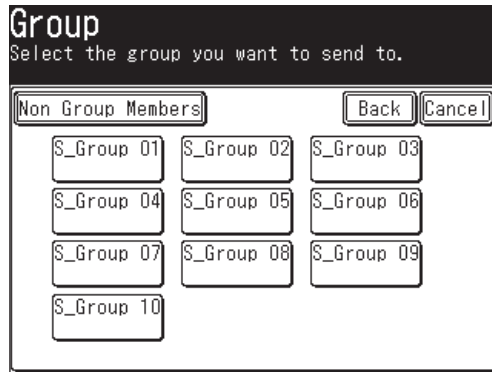

- 7 Press [Enter].

Using address book number

If you know the address book number, you can quickly send to that location by entering that number. The destinations are numbered when they are registered.

- 1 Set the document.
- 2 Press [SCAN] on the control panel.
- 3 Press [e-mail].
- 4 Press [Others].
- 5 Press [Address Book].

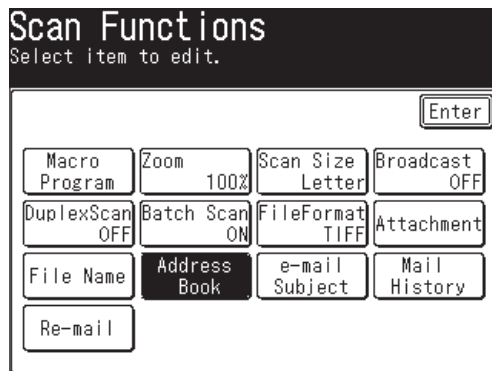

NOTE: You can assign [Address Book] to the soft key. See “Soft keys” on page 10-4.

- 6 Use [▲] [▼] or the numeric keys and enter the address book number.

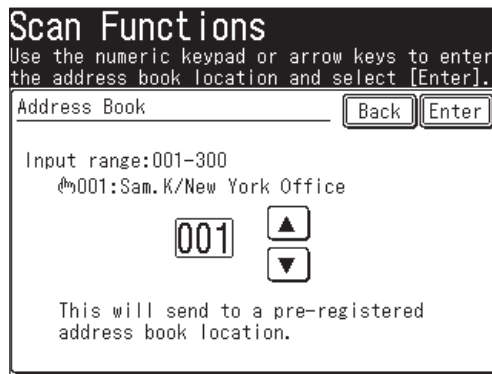

- 7 Press [Enter].

Searching for an e-mail address

You can quickly search for a contact located in your machine-side address book or on an LDAP server.

NOTE: In order to search an LDAP server, the server must be registered in advance. For more information about set up, see the “Network Guide”.

Simple search

You can search for an e-mail address by entering the contact name, part of the contact name or a part of the e-mail address.

- 1 Press [SCAN] on the control panel.
- 2 Press [e-mail].
- 3 Press [Search].

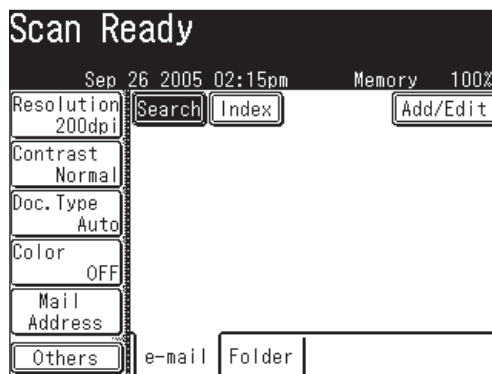

- 4 Use the QWERTY keypad or numeric keys to enter criteria. This should contain the contact name, part of the contact name or part of the e-mail address.



- 5 Press [Execute].
- 6 Every name and e-mail address including the criteria will be displayed. If there are no results, "Hit:0000" will be displayed.

Press [Page Up] and [Page Down] to search the results.

If the address displayed is from the LDAP server, it will have an  next to it. Select this button to view the contact information and/or register the contact into your address book. Press [Close] to close the window.

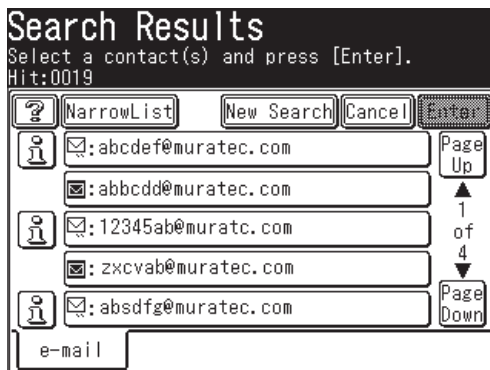

- 7 If your search yields too many contacts, select [Narrow List] to further narrow your search.
- 8 If you want to start a new search, press [New Search] and search again. Refer to steps 4 to 6 how to search .
- 9 Continue searching until you find your desired contact(s). If you press [Back] on the "Simple Search" screen you will return to the "Search Results" screen.
 - Press [Cancel] to return to the standby screen.
- 10 Select the desired destination(s).

NOTE: If you cannot find your desired contact(s), please confirm that the search criteria was entered correctly. If this does not solve the problem, contact your network administrator.

Advanced search

You can add more criteria to your search by selecting [Advanced].

- 1 Press [SCAN] on the control panel.
- 2 Press [e-mail].
- 3 Press [Search].
- 4 Press [Advanced].

Simple Search
Enter the search parameter and select [Execute]. Entry Limit 0/99
? Server Advanced Back Cancel Execute
Look For:_
1 2 3 4 5 6 7 8 9 0
Q W E R T Y U I O P
A S D F G H J K L @
_ Z X C V B N M . , .COM
Lower Symbol Space [Enter] Delete [Left] [Right]

- 5 Enter your search criteria. Select [AND] or [OR]. Refer to the table below for definitions.

Advanced Search
Enter the search parameter(s) and select [Execute].
? Server Back Cancel Execute
AND OR
Name : Not Use
Fax : Not Use
e-mail: Not Use
AND
Dept. : Not Use

And Searches for contacts that meet all the entered criteria.

Or Searches for contacts that meet any of the entered criteria.

Name Enter a name or a part of a name to be searched.

Fax Enter a fax number or a part of a fax number to be searched.

e-mail Enter part of the e-mail address to be searched.

Dept. This means department. It is not an independent field. To use this field either the Name, Fax or e-mail should also be entered.

-
- NOTE:**
- If you are entering the e-mail field, you may select [Copy Name]. This will import information that has been entered in the “Name” field.
 - If too many special characters (such as umlaut) are entered in each field, the message “LDAP reference execution error” may appear and the LDAP searching will not be performed. In this case, decrease the special character entering.
-

NOTE: [Not Use] is the default search criteria. If you enter character(s) in the Name, Fax or e-mail field this button will change to [Any]. If you want to use criteria other than [Any], select this button to view other selection.

6 Press [Any] to change the criterion, if needed.

Advanced Search
Enter the search parameter(s) and select [Execute].

? Server Back Cancel Execute

AND OR

Name : Mürax Any

Fax : Not Use

e-mail: Not Use

AND

Dept. : Not Use

Select desired criterion.

Advanced Search
Select the Search Method and press [Enter].

Search Method Back Cancel Enter

Any Initial Final

Equal Not Use

This will search any information that has been entered into the line item, including blanks.

Any Searches any information in this field, including “blanks”.

Initial Searches for contacts that begin with the characters entered in this field.

Final Searches for contacts that end with the characters entered in this field.

Equal Searches for contacts that match exactly with the information entered in this field.

Not Use Information in this field (including blanks) will not be used for searching.

7 Press [Enter].

8 Press [Execute].

- 9 The search results will be displayed. If there are no results, “Hit:0000” will be displayed.

Press [Page Up] and [Page Down] to view all the results.

If the address displayed is from the LDAP server, it will have an  next to it. Select this button to view the contact information and/or register the contact into your address book. Select [Close] to close the window.

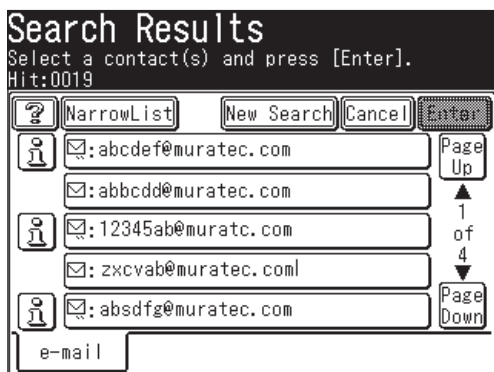

- 10 If your search yields too many contacts, select [Narrow List] to further narrow your search. Refer to steps 5 to 8 how to search.
- 11 If you want to start a new search, press [New Search] and search again. Refer to steps 5 to 8 how to search.
- 12 Continue searching until you find your desired contact(s). If you press [Back] on the “Advanced Search” screen you will return to the “Search Results” screen.
- Press [Cancel] to return to the standby screen.
- 13 Select the desired destination(s).

NOTE: If you cannot find your contact(s), please confirm that the search criteria was entered correctly. If this does not solve the problem, ask your network administrator.

Registering a destination from the search results screen

If you locate a contact on an LDAP server and wish to register them into your machine-side address book, please follow these steps:

- 1 Execute either a simple search or advanced search.

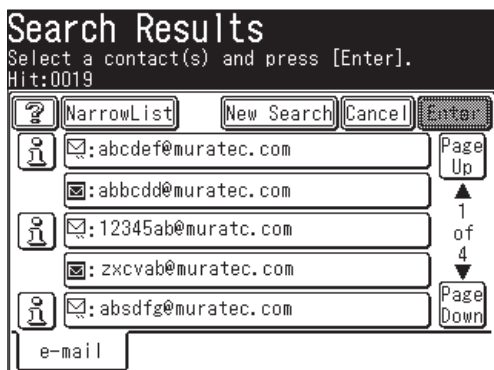

- 2 Once the “Search Results” screen appears, select the  next to the contact you wish to register.

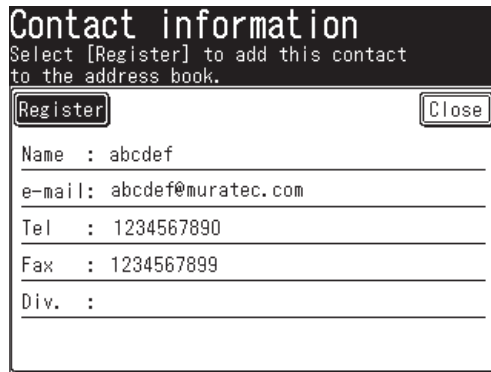

Contact information
Select [Register] to add this contact to the address book.

Name : abcdef

e-mail: abcdef@muratec.com

Tel : 1234567890

Fax : 1234567899

Div. :

- 3 Press [Register].
- 4 Select an address book entry number using [▲] [▼] or the numeric keys. You cannot select a number that has already been registered.

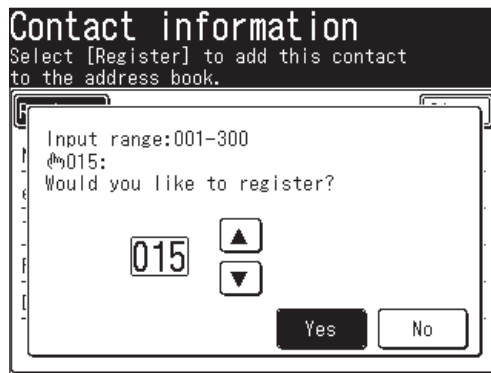

Contact information
Select [Register] to add this contact to the address book.

Input range:001-300

015: Would you like to register?

015 ▲ ▼

- 5 Press [Yes].
- 6 Enter the [Name], [Fax No] or [Group] information as needed. The [Name] field must be registered.

For more information how to enter them, see “Registering or editing an address book number“ from page 2-4.

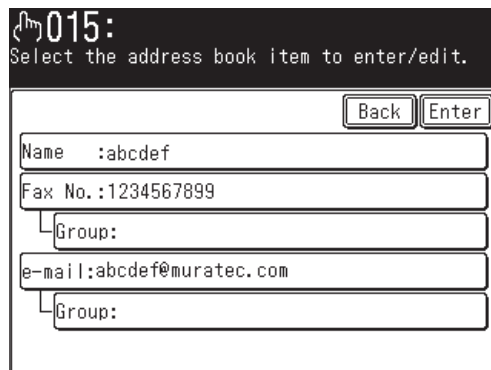

015:
Select the address book item to enter/edit.

Name : abcdef

Fax No. : 1234567899

Group:

e-mail: abcdef@muratec.com

Group:

- 7 Press [Enter].
- 8 To return to the standby mode, press [Reset].

Sending a document using the mail history

The last 20 manually entered e-mail locations you sent will be stored in the mail history. You can send documents to these locations by simply selecting them from this listing.

NOTE: E-mail addresses registered in the address book will not appear in the mail history. Only the last 20 addresses entered manually will be displayed in the order in which they were sent (most recent location listed first). The same location will not appear multiple times on this list, the last time in which it was used.

- 1 Press [SCAN] on the control panel.
- 2 Press [e-mail].
- 3 Press [Others].
- 4 Press [Mail History].

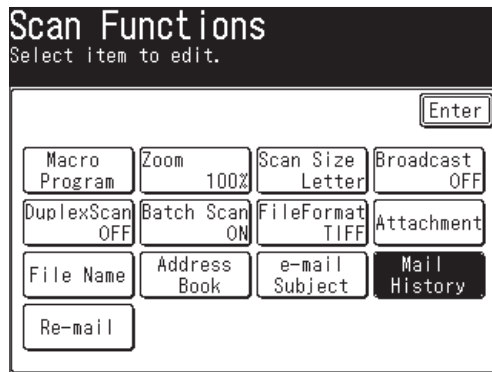

NOTE: You can assign [Mail History] to the soft key. See “Soft keys” on page 10-4.

- 5 Select the desired e-mail address. Use [Prev] or [Next] to toggle through the e-mail history.

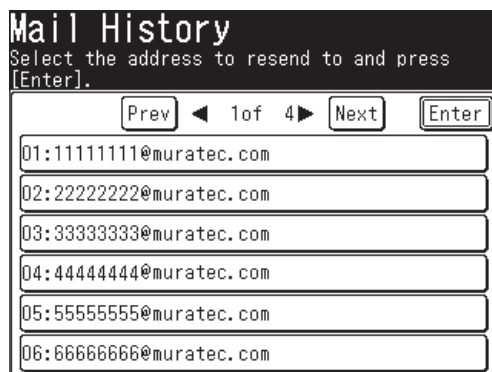

- If you want to edit an existing e-mail address, use the QWERTY keypad or numeric keys to do so.



- Press [Enter].

Re-mail

This button will recall the last e-mail address you sent to.

- Set the document.
- Press [SCAN] on the control panel.
- Press [e-mail].
- Press [Others].
- Press [Re-mail].

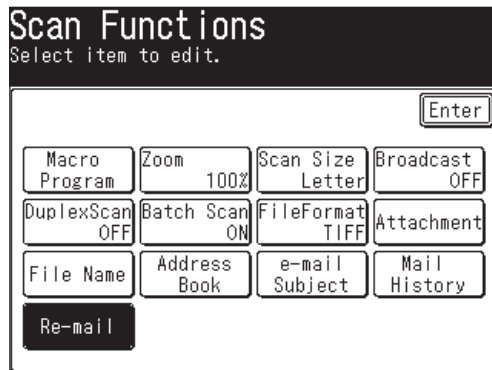

NOTE: You can assign [Re-mail] to the soft key. See “Soft keys” on page 10-4.

- The last used e-mail address you sent to will be displayed.

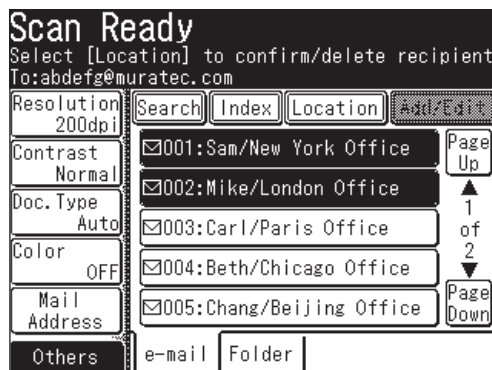

Reviewing or changing your selected destinations

When you have entered multiple destinations, you can review, cancel or change the broadcast status of the destinations.

NOTE: This function is only available prior to scanning the document.

- 1 After the destinations have been entered, press [Location].

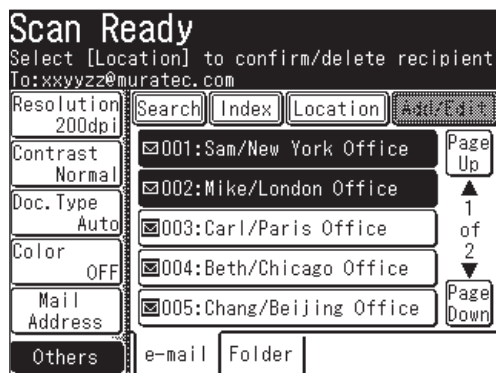

- 2 Press [Page Up] or [Page Down] and review all the entered e-mail and folder destinations.



- 3 Every time you press [To], the status changes from [To] to [Cc], then [Bcc] in that order. Press the key until it changes to your desired status.
Pressing [Sort] will sort the e-mail destinations in [To], [Cc] and [Bcc] order.
- 4 To delete e-mail or folder destinations, select the destinations to delete and press [Delete].
- 5 Press [Enter] to return to screen 1.

Adding a text message to your e-mail

When you send a document to an e-mail address, a fixed subject and text are entered automatically. However you can manually enter an e-mail subject line and text to the transmission.

Editing the subject line and text message

- 1 Set the document.
- 2 Press [SCAN] on the control panel.
- 3 Press [e-mail].
- 4 Press [Others].
- 5 Press [e-mail Subject].

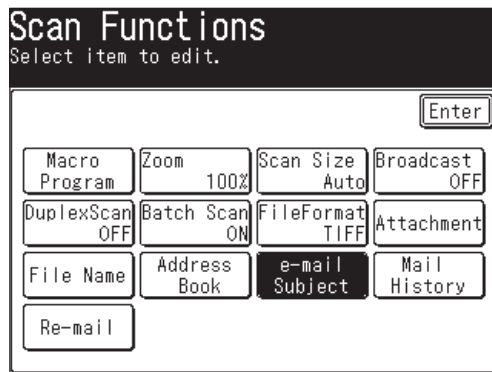

NOTE: You can assign [e-mail Subject] to the soft key. See “Soft keys” on page 10-4.

- 6 Press [Subject].

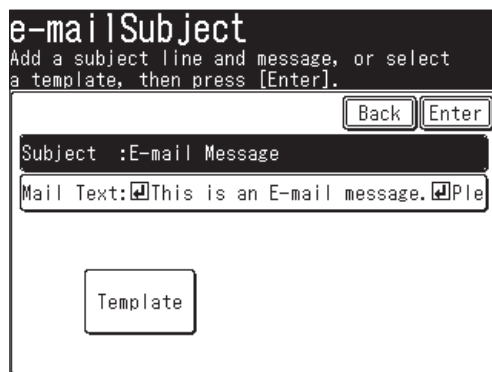

- 7 Enter the subject. The subject can contain up to 80 characters.

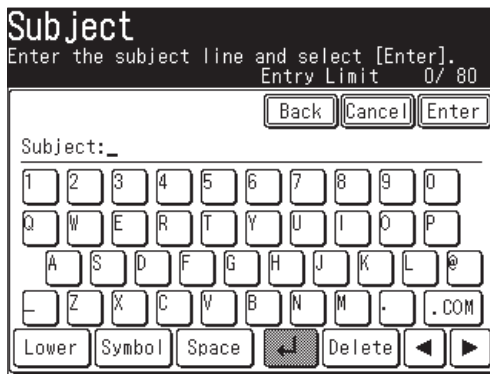

- 8 Press [Enter].

- 9 Press [Mail Text].

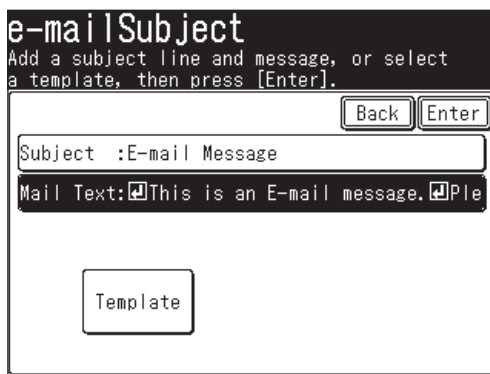

- 10 Enter the text message.

NOTE: The mail text can contain up to 1024 characters. “Return” is counted as two characters and can be used twice.

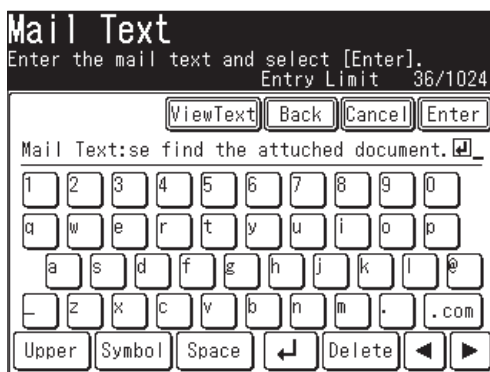

- 11 To view the entire text message, press [View Text]. Use the arrows to view all the text. Press [Enter] to close to return to the QWERTY keypad.

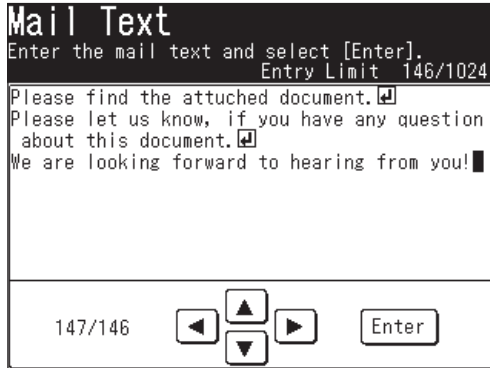

- 12 Press [Enter].
- 13 Select a destination(s).
- 14 Press [Start].

Using a registered template

You can select a registered template to simplify the entry process. You can register up to ten templates.

NOTE: The template should be registered in advance. (See the “Network Guide” for instruction.)

- 1 Set the document.
- 2 Press [SCAN] on the control panel.
- 3 Press [e-mail].
- 4 Press [Others].
- 5 Press [e-mail Subject].
- 6 Press [Template].

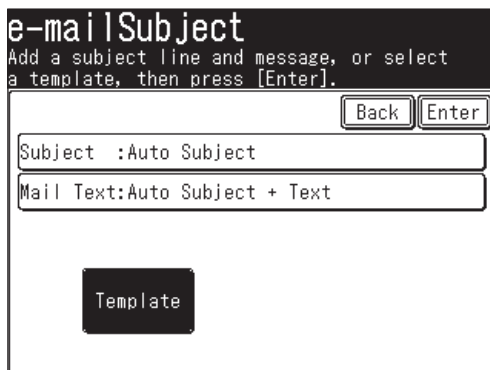

- 7 Select the desired template.
If the desired template is not shown on the display, press [Page Up] or [Page Down] to go to the next page.

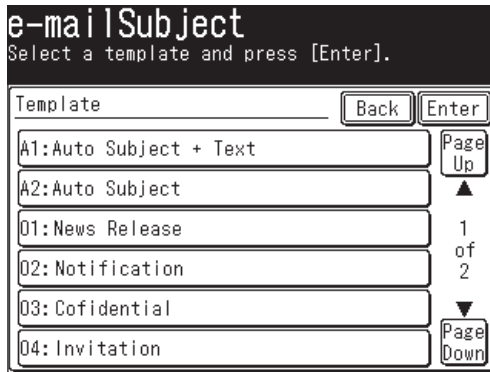

- 8 Press [Enter].
- 9 If you want to edit the subject or the text message, select either [Subject] or [Mail Text] and edit it. Refer steps 6 to 12 on pages 5-24 to 5-26 for instructions.
- 10 Select a destination(s).
- 11 Press [Start].

Changing the default text message

- 1 Press [Setting] on the control panel.
- 2 Press [Mail Settings].
- 3 Press [Subject].
- 4 Press [ON], then [Enter].
- 5 Select the desired template, and press [Enter].

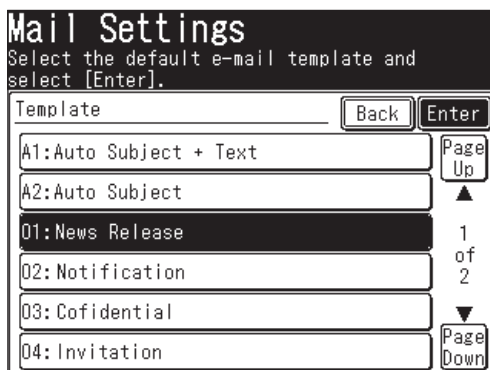

- 6 To return to the standby mode, press [Reset].

Scan to folder

Scanning documents into a folder

You can scan a document directly into a network folder.

NOTE: To save a scanned document to a folder, you should have a shared folder in your computer. Create a shared folder in advance, referring to your PC manual if necessary.

- 1 Set the document.
- 2 Press [SCAN] on the control panel.
- 3 Press [Folder].

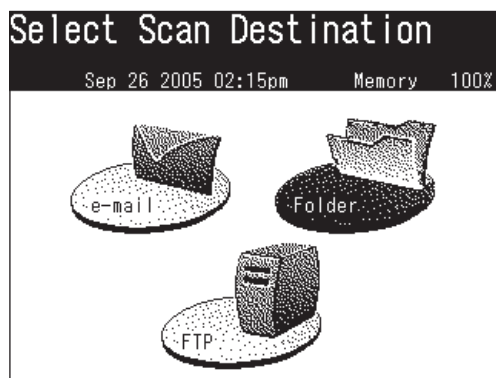

- 4 Adjust the scan settings, or set advanced functions.

For more information about those functions, see “Before scanning” on pages 5-2 to 5-8 and “Advanced functions” on pages 5-56 to 5-66.

- 5 Press [Browse]. The “Network Navigation” screen will be displayed.

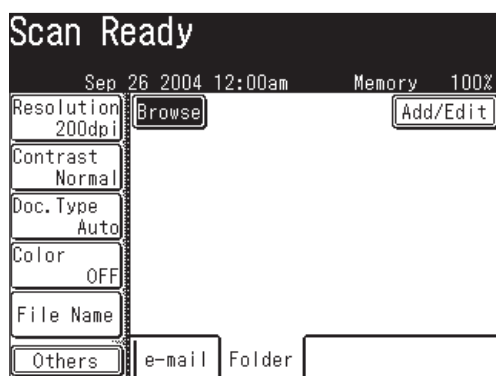

NOTE: The following folders will not be browsed from your machine:

- Folders that are not in the same segment with your machine.
 - Folders that name contain 13 or more characters.
 - Folders that link contain more than 100 characters in length.
-

- 6 All accessible networks will be displayed. To scroll, use [Page Up] and [Page Down].

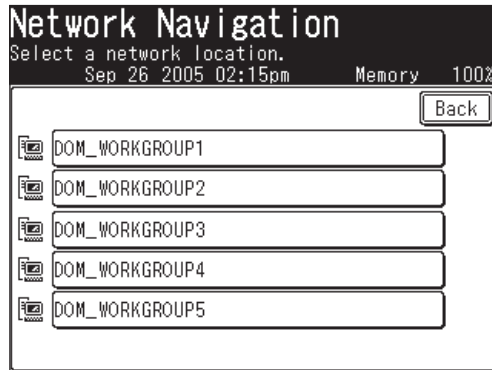

- 7 Select the network that contains your desired folder.
- 8 Search through the network folders until you find the specific folder you wish to scan to.

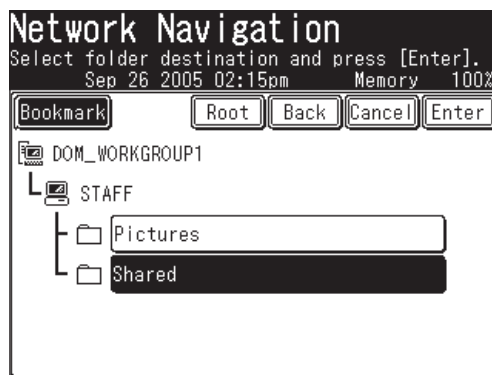

- To go up one step, press [Back].
 - To return to the first screen, press [Root].
- 9 If the user name and password are required to login to the file server, press [UserName]. Otherwise skip to step 13.

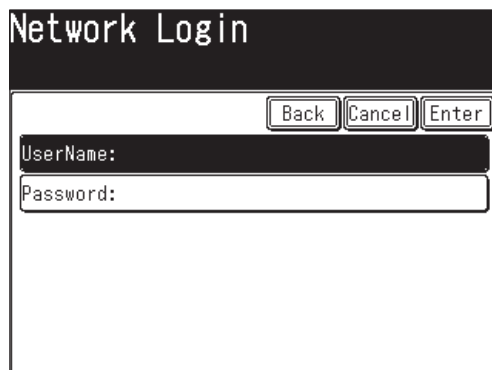

10 Enter the user name, then press [Enter].

If your machine is on a windows domain controlled network, add the domain name after the user name with an “@”, like “sam@dom_muratec”.

The user name can contain up to 50 characters.

All ASCII characters are available.

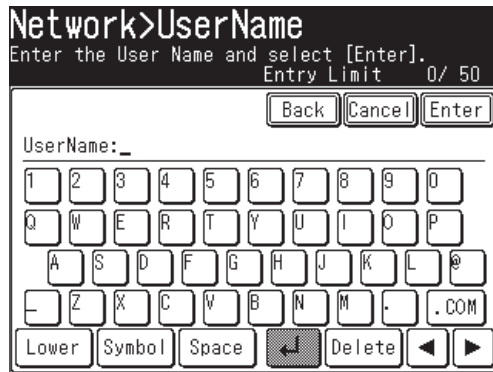

11 Press [Password].

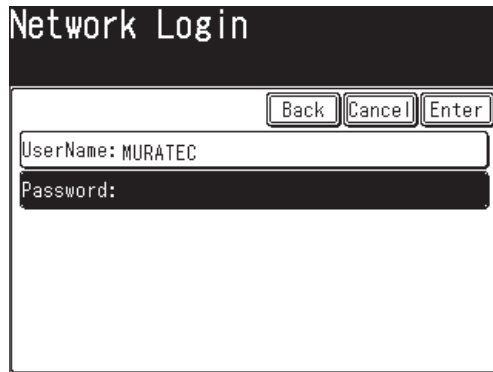

12 Enter the password, then press [Enter].

The password can contain up to 32 characters.

All ASCII characters are available.



NOTE: The entered password is displayed using asterisks.

13 Press [Start].

Registering a folder shortcut from the browse screen

After you find the folder you wish to scan to you may register it as a folder shortcut, allowing for instant network scanning to a specified folder. Up to 20 shortcuts can be registered.

- 1 After you locate your desired folder, select the location and press [Bookmark].

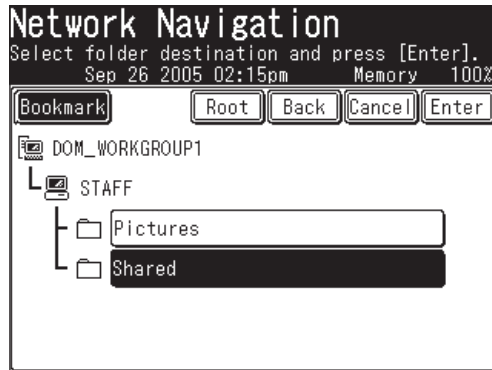

- 2 Select a shortcut number using [▲] [▼] or the numeric keys. You can select either a new number, or overwrite an existing number.

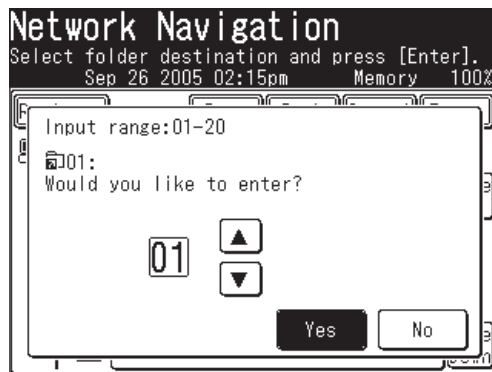

- 3 Select [Yes].
- 4 Register the [Shortcut], [User Name] and [Password] as needed.
 - **Shortcut Name** — This is the name that will be displayed on the shortcut key. The name can contain up to 24 characters. If you do not register a shortcut name, the folder link will be displayed on the shortcut key.
 - **User Name, Password** — If you have entered an user name and password they will be displayed (the password will be displayed using asterisks).

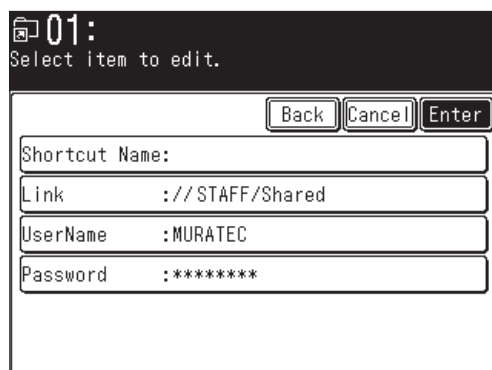

5 To Enter the Shortcut name, press [Shortcut Name].

6 Enter a shortcut name, then press [Enter].

The name can contain up to 24 characters. If you do not register a shortcut name, the folder link will be displayed on the shortcut key. When the link is too long to be displayed on the key, it will be omitted at the center with “.” and only the beginning and ending of the link will be displayed.



7 Press [Enter].

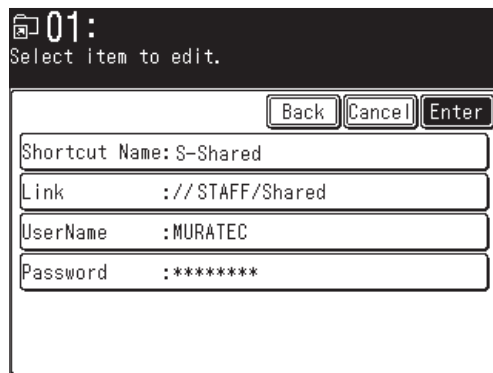

- To finish without registering the shortcut, press [Cancel].
- To return to the screen in step 4, press [Back].

8 To return to the standby mode, press [Reset].

To edit or delete the shortcut information, see “Resitering or editing a folder shortcut” on pages 5-35 to 5-41.

Scanning documents using a folder shortcut

NOTE: The folders should be registered in advance. For more information, see “Resitering or editing a folder shortcut” on pages 5-35 to 5-41.

NOTE: Scanning will begin once the shortcut key has been pressed. If you want to scan to multiple folder shortcuts, select [Broadcast] prior to destination selection.

- 1 Set the document.
- 2 Press [SCAN] on the control panel.
- 3 Press [Folder].
- 4 Select the desired shortcut key on the display.
If it is not displayed, press [Page Up] or [Page Down].

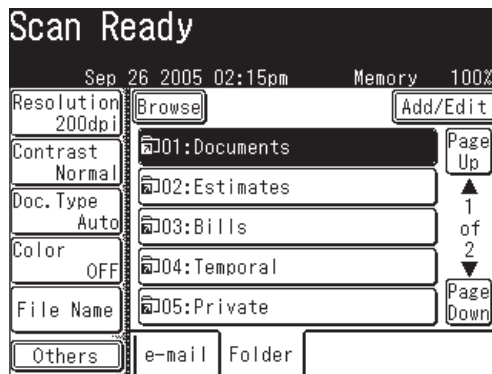

Reviewing or canceling selected folders

You can quickly review or cancel the folders you selected.

NOTE: This function is only available prior to scanning the document.

- 1 After the destinations have been selected, press [Location].
- 2 Press [Page Up] or [Page Down] and review all the entered folders and e-mail destinations.

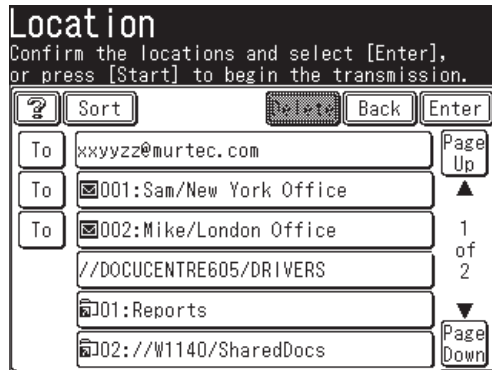

- 3 Every time you press [To], the status changes from [To] to [Cc], then [Bcc] in that order. Press the key until it changes to your desired status.
Pressing [Sort] will sort the e-mail destinations in [To], [Cc] and [Bcc] order.
- 4 To delete e-mail or folder destinations, select the destinations to delete and press [Delete].
- 5 Press [Enter] to return to screen 1.

Registering or editing a folder shortcut

Registering a folder shortcut

You can create a folder shortcut on your machine.

NOTE: You can register up to 20 shortcuts.

- 1 Press [Setting].
- 2 Press [Scanner Settings].

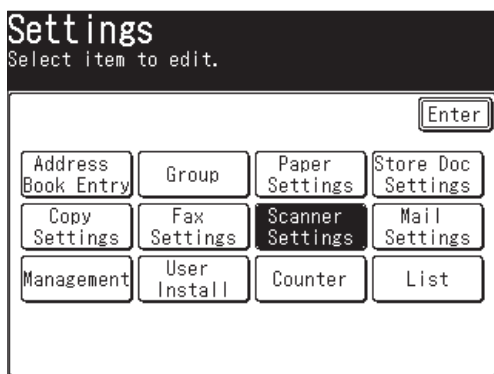

- 3 Press [Folder Shortcut].

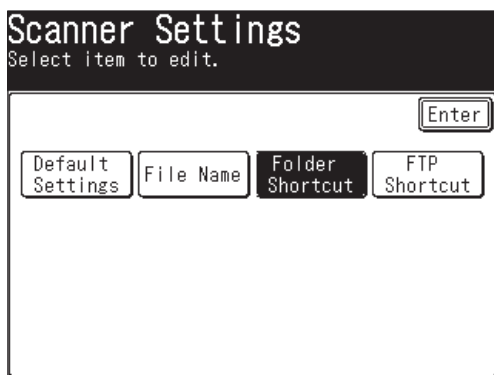

- 4 Press [Add/Edit].



- 5 Select an empty key.

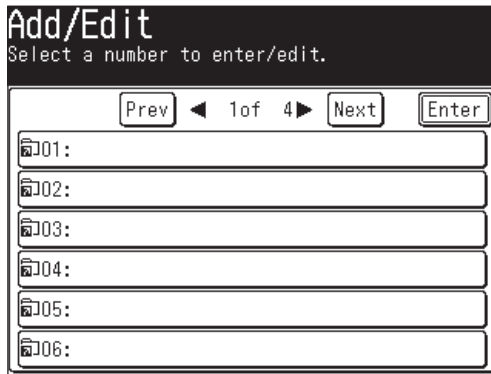

- 6 Press [Shortcut Name].

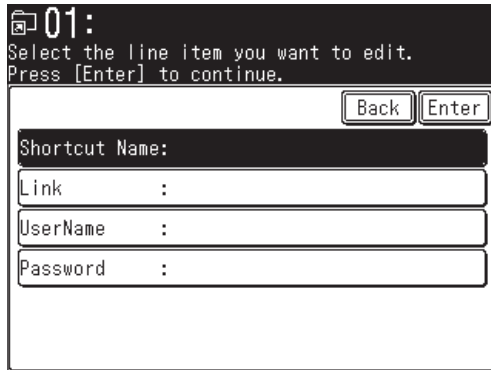

- 7 Enter a shortcut name, then press [Enter].

The name can contain up to 24 characters. If you do not register a shortcut name, the folder link will be displayed on the shortcut key. When the link is too long to be displayed on the key, it will be omitted at the center with "." and only the beginning and ending of the link will be displayed.

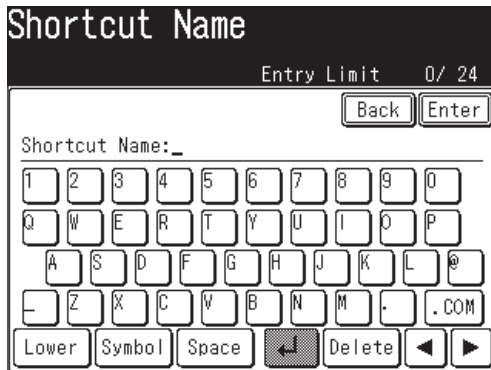

8 Press [Link]. The “Network Navigation” screen will be displayed.

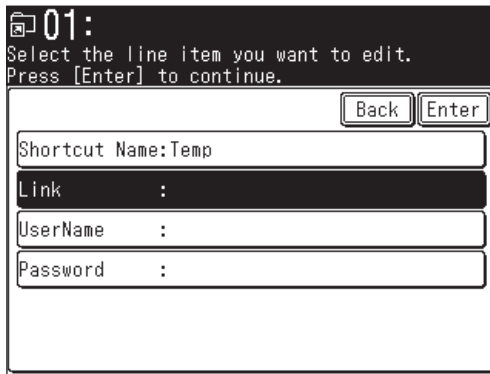

9 All accessible networks will be displayed. To scroll, use the [Page Up] and [Page Down].

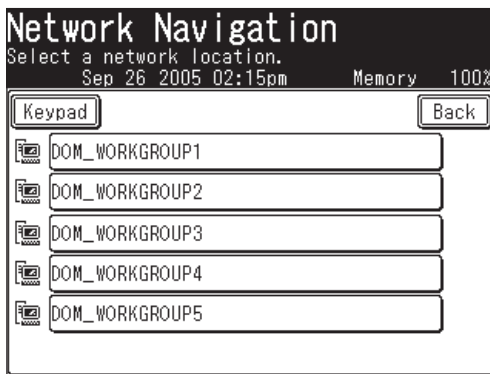

NOTE: If you want to directly specify a folder using the QWERTY keypad, press [Keypad]. Then enter a link and press [Enter].

10 Search through the network folders until you find the specific folder you wish to register to, and press [Enter].

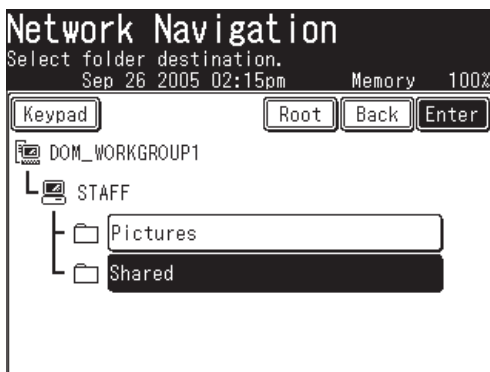

- To go up one step, press [Back].
- To return to the first screen, press [Root].

NOTE: The link should be within 100 characters in length.

- 11** If the user name and password are required to login to the file server, press [UserName]. Otherwise skip to step 15.

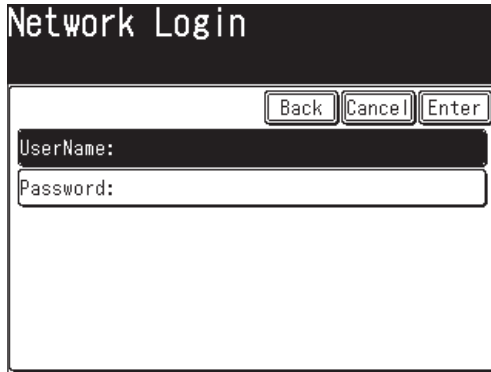

The image shows a terminal window titled "Network Login". At the top right are three buttons: "Back", "Cancel", and "Enter". Below them are two input fields. The first is labeled "UserName:" and is currently empty. The second is labeled "Password:" and is also empty. The rest of the screen is blank.

- 12** Enter the user name, then press [Enter].

If your machine is on a windows domain controlled network, add the domain name after the user name with an "@", like "sam@dom_muratec".

The user name can contain up to 50 characters.

All ASCII characters are available.



The image shows the "Network Login" screen with a virtual keyboard overlay. The title bar reads "Network>UserName". Below the title bar, it says "Enter the User Name and select [Enter]. Entry Limit 0/ 50". There are "Back", "Cancel", and "Enter" buttons. The "UserName:" field contains a single underscore character "_". The keyboard overlay includes rows for numbers 1-0, letters Q-P, letters A-L and @, letters Z-C and N-M, and symbols like "Lower", "Symbol", "Space", "Enter", and "Delete".

- 13** Press [Password].

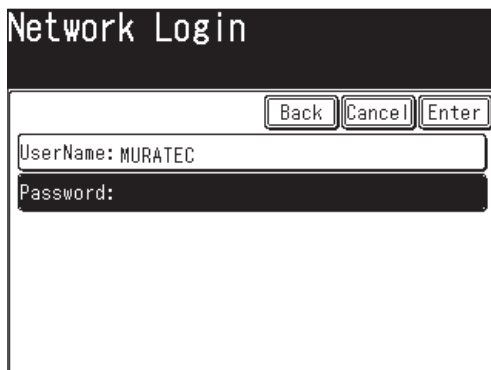

The image shows the "Network Login" screen. The "UserName:" field now contains the text "MURATEC". The "Password:" field remains empty. The "Back", "Cancel", and "Enter" buttons are still present at the top.

14 Enter a password, then press [Enter].

The password can contain up to 32 characters.

All ASCII characters are available.



NOTE: The entered password is displayed using asterisks.

15 Press [Enter].

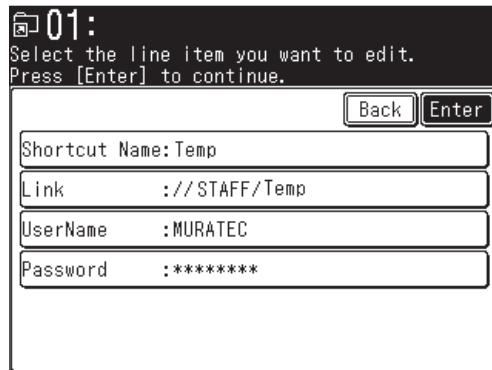

16 If you want to register more shortcuts, repeat the procedures from step 5.

17 To return to the standby mode, press [Reset].

Editing a folder shortcut

- 1 Press [Setting].
- 2 Press [Scanner Settings], [Folder Shortcut], [Add/Edit].

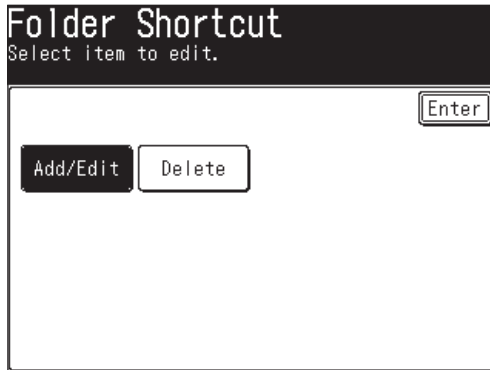

- 3 Select the shortcut you want to edit.

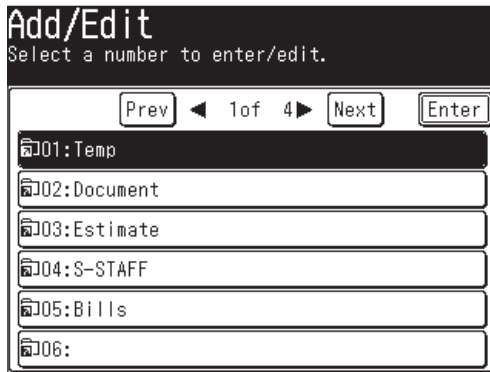

- 4 Edit the desired field.

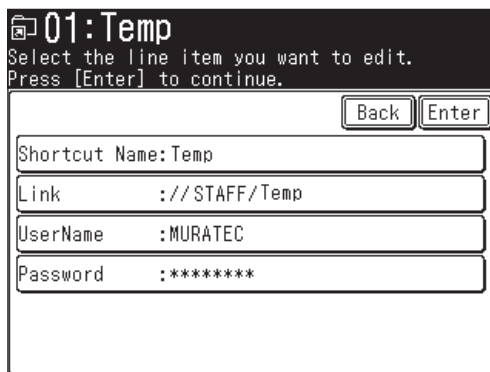

- 5 After editing, press [Enter].
- 6 To return to the standby mode, press [Reset].

Deleting a folder shortcut

- 1 Press [Setting].
- 2 Press [Scanner Settings], [Folder Shortcut], [Delete].

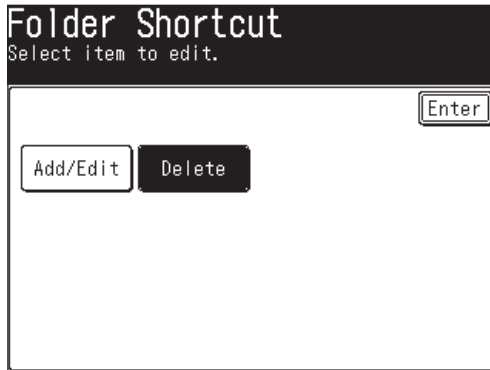

- 3 Select the shortcut you want to delete.

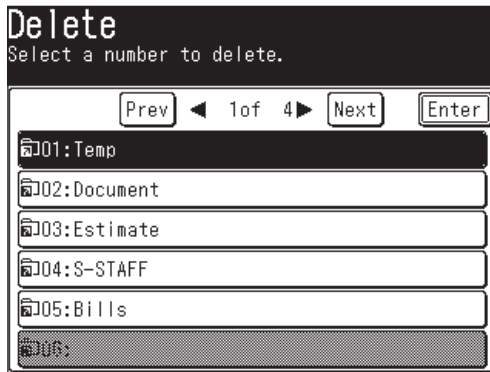

- 4 Press [Yes] to delete.



- 5 To return to the standby mode, press [Reset].

Scan to FTP

Scanning documents to an FTP server

You can easily scan a document(s) to an FTP server.

- 1 Set the document.
- 2 Press [SCAN] on the control panel.
- 3 Press [FTP].

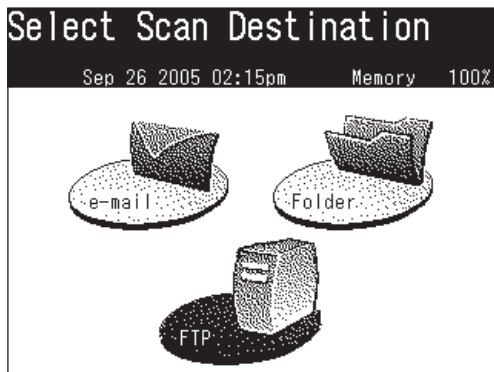

- 4 Adjust the scan settings, or set any advanced functions.

For more information about those functions, see “Before scanning” on pages 5-2 to 5-8 and “Advanced functions” on pages 5-56 to 5-66.

- 5 Press [Host].

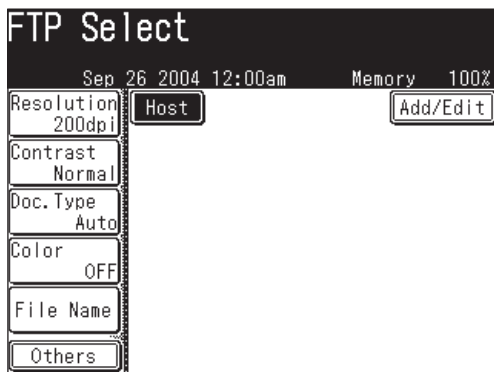

6 Press [Link].

Host
Enter the host information and select [Enter]

Register Back Enter

Shortcut Name:

Link :

UserName :

Password :

7 Enter the link to the FTP server. The entry can contain up to 100 characters. Begin your entry with “/”.

The “/(slash)” is found in the [Symbol] menu. To switch back to the alphabet, press [Alpha].

Link
Enter the Link and select [Enter].
Entry Limit 0/100

Back Cancel Enter

Link: _

1 2 3 4 5 6 7 8 9 0
Q W E R T Y U I O P
A S D F G H J K L @
_ Z X C V B N M . , .COM
Lower Symbol Space Delete

8 Press [Enter].

9 Press [User name].

Host
Enter the host information and select [Enter]

Register Back Enter

Shortcut Name:

Link : //muratec.com/FTPXYZ

UserName :

Password :

- 10 Enter the user name using the QWERTY keypad and numeric keys. The user name can contain up to 50 characters. All ASCII characters are available.

FTP>UserName
Enter the User Name and select [Enter].
Entry Limit 0/ 50

Back Cancel Enter

UserName: _

1 2 3 4 5 6 7 8 9 0
Q W E R T Y U I O P
A S D F G H J K L @
_ Z X C V B N M . , .COM
Lower Symbol Space Delete

- 11 Press [Enter].

- 12 Press [Password].

Host
Enter the host information and select [Enter]

Register Back Enter

Shortcut Name:
Link ://muratec.com/FTXYZ
UserName :MURATEC
Password :

- 13 Enter the password using the QWERTY keyboard and numeric keys. The password can contain up to 32 characters. All ASCII characters are available.

FTP>Password
Enter the Password and select [Enter].
Entry Limit 0/ 32

Back Cancel Enter

Password: _

1 2 3 4 5 6 7 8 9 0
Q W E R T Y U I O P
A S D F G H J K L @
_ Z X C V B N M . , .COM
Lower Symbol Space Delete

NOTE: The entered password is displayed using asterisks.

- 14 Press [Enter].

15 Press [Enter].

Host
Enter the host information and select [Enter]

Register Back Enter

Shortcut Name:

Link ://murate.com/FTPXYZ

UserName :MURATEC

Password :*****

16 Press [Start].

Registering an FTP server to a shortcut

After you entered an FTP link, you may register it as a shortcut for instant recall. Up to 20 shortcuts can be registered.

- 1 After you enter the [Link], [User Name] and [Password], press [Shortcut Name].

Host
Enter the host information and select [Enter]

Register Back Enter

Shortcut Name:

Link ://muratec.com/FTPXYZ

UserName :MURATEC

Password :*****

- 2 Register the [Shortcut Name].
 - **Shortcut Name** — This is the name that will be displayed on the shortcut key. The name can contain up to 24 characters. If you do not register a name, the FTP link will be displayed on the shortcut key. When the link is too long to be displayed on the key, it will be omitted at the center with “.” and only the beginning and ending of the link will be displayed.

FTP>ShortcutName
Enter the Shortcut Name and select [Enter].
Entry Limit 0/24

Back Cancel Enter

Shortcut Name: _

1 2 3 4 5 6 7 8 9 0
Q W E R T Y U I O P
A S D F G H J K L @
_ Z X C V B N M . .COM
Lower Symbol Space Delete

3 Press [Enter].

4 Press [Register].

Host
Enter the host information and select [Enter]

Register Back Enter

Shortcut Name: XYZ

Link : //muratec.com/FTPXYZ

UserName : MURATEC

Password : *****

5 Select a shortcut number using [Page Up] and [Page Down] or the numeric keys. You can select either a new number, or overwrite a number that has been registered.

Host
Enter the host information and select [Enter]

Input range: 01-20

01: Would you like to enter?

01 ▲ ▼

Yes No

6 Press [Yes].

7 To return to the standby mode, press [Reset].

To edit or delete the shortcut information, see “Registering or editing an FTP server shortcut” on pages 5-49 to 5-55.

Scanning documents using an FTP shortcut

NOTE: The FTP server shortcut should be registered in advance. For more information, see “Registering or editing an FTP server shortcut” on pages 5-49 to 5-55.

NOTE: Scanning will begin once the shortcut key has been pressed. If you want to scan to multiple FTP shortcuts, select the [Broadcast] prior to destination selection.

- 1 Set the document.
- 2 Press [SCAN] on the control panel.
- 3 Press [FTP].
- 4 Select the desired shortcut. If it is not displayed, press [Page Up] or [Page Down].

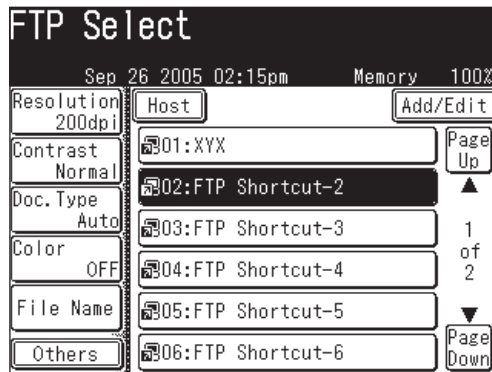

Reviewing or canceling selected FTP servers

You can quickly review or cancel the FTP servers you have selected.

Note: This function is only available prior to scanning the document.

- 1 After the FTP servers have been selected, press [Location].



- 2 Review the entered FTP servers.

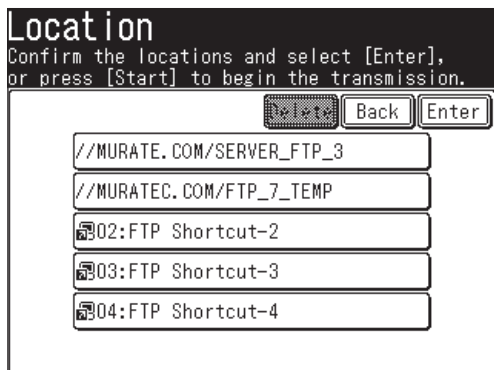

- 3 To delete a server(s), select the destination(s) you wish to delete and press [Delete].
- 4 Press [Enter] to return to screen 1.

Registering or editing an FTP server shortcut

Registering an FTP server shortcut

You can create an FTP (File Transfer Protocol) shortcut on your machine.

NOTE: You can register up to 20 shortcuts.

- 1 Press [Setting].
- 2 Press [Scanner Settings].

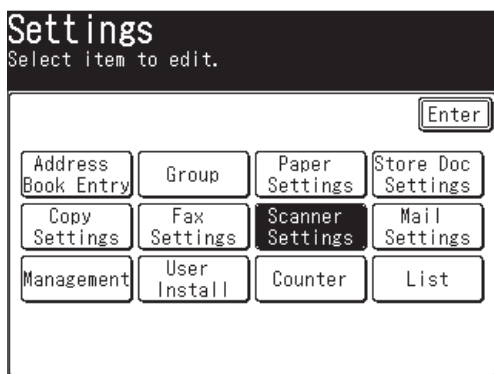

- 3 Press [FTP Shortcut].

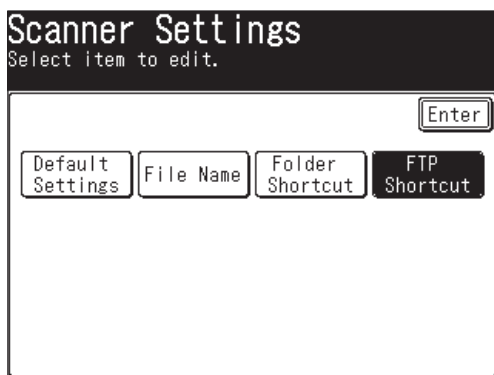

- 4 Press [Add/Edit].



5 Select an empty key.

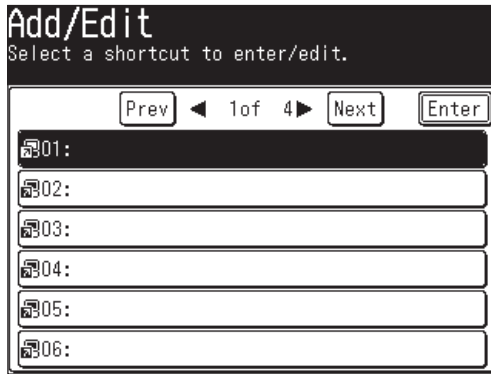

6 Press [Shortcut Name].

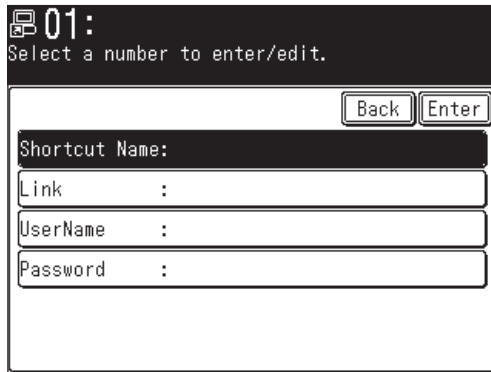

7 Enter a shortcut name, then press [Enter].

The name can contain up to 24 characters. If you do not register a name, the FTP link will be displayed on the shortcut key. When the link is too long to be displayed on the key, it will be omitted at the center with "." and only the beginning and ending of the link will be displayed.

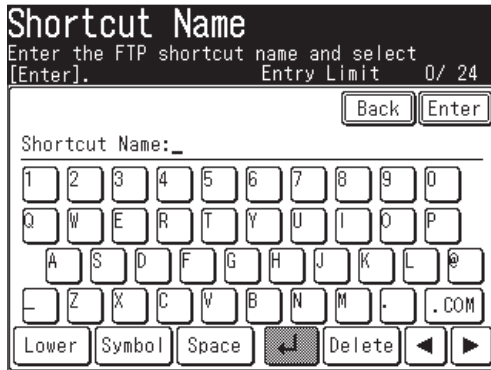

8 Press [Link].

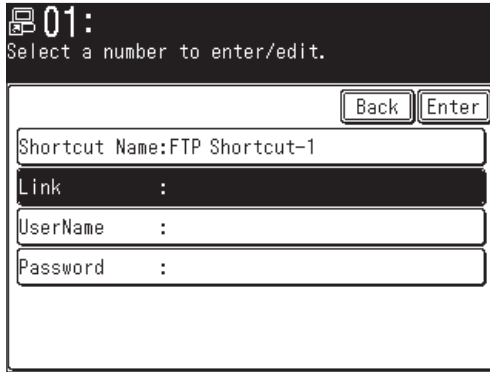

9 Enter link, then press [Enter].

Begin your entry with “/”.

The “/(slash)” is found in the [Symbol] menu. To switch back to the alphabet, press [Alpha].

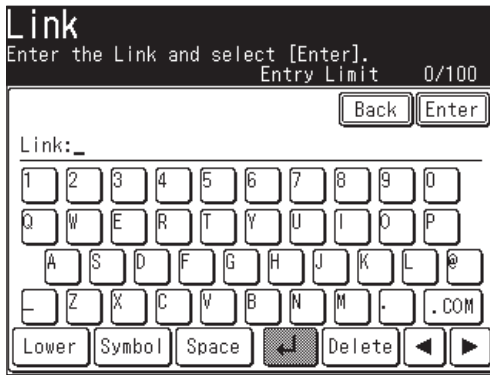

10 Press [UserName].

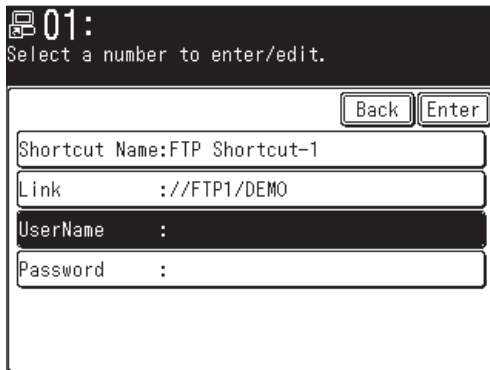

- 11** Enter the user name, then press [Enter].

The user name can contain up to 50 characters. All ASCII characters are available.



- 12** Press [Password].

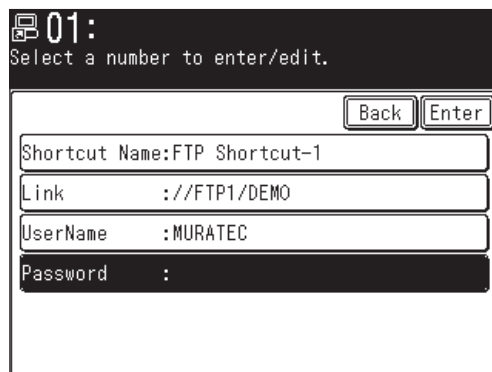

- 13** Enter the password, then press [Enter].

The password can contain up to 32 characters. All ASCII characters are available.



NOTE: The entered password is displayed using asterisks.

14 Press [Enter].

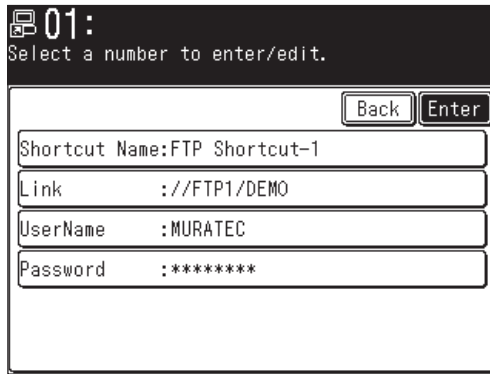

The screenshot shows a device menu with a dark background. At the top, it displays '01:' and the instruction 'Select a number to enter/edit.'. Below this, there are two buttons: 'Back' and 'Enter'. The main content area contains four input fields with labels and values: 'Shortcut Name:FTP Shortcut-1', 'Link ://FTP1/DEMO', 'UserName :MURATEC', and 'Password :*****'.

15 If you want to register another shortcut, repeat procedure from step 5.

16 To return to the standby mode, press [Reset].

NOTE: We recommend you to test your registered FTP Shortcut by sending something soon after your have registered it. It is the best way to verify that the registered Shortcut is all right.

Editing an FTP shortcut

- 1 Press [Setting].
- 2 Press [Scanner Settings], [FTP Shortcut], [Add/Edit].

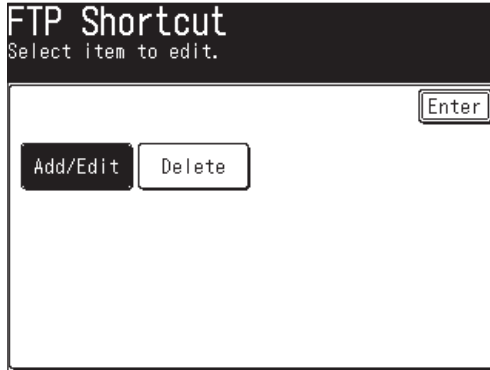

- 3 Select the shortcut you want to edit.

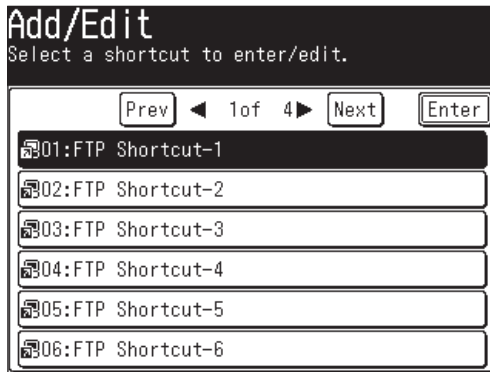

- 4 Edit the desired item.

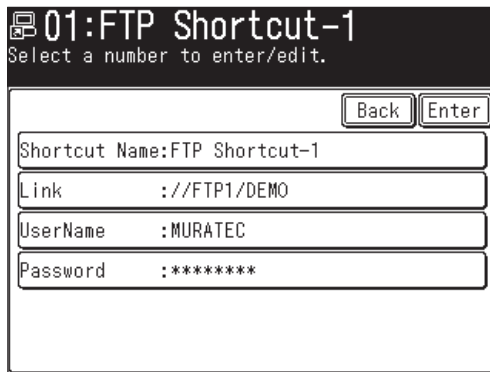

- 5 After editing, press [Enter].
- 6 To return to the standby mode, press [Reset].

Deleting an FTP shortcut

- 1 Press [Setting].
- 2 Press [Scanner Settings], [FTP Shortcut], then [Delete].

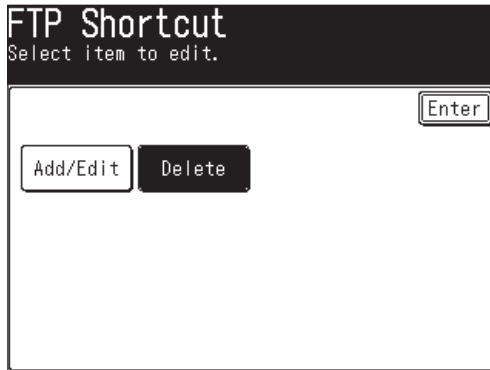

- 3 Select the shortcut you want to delete.

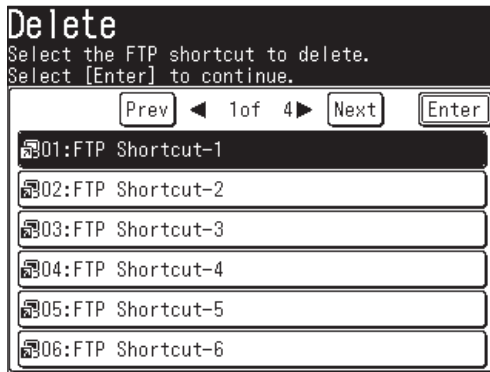

- 4 Press [Yes] to delete.



- 5 To return to the standby mode, press [Reset].

Advanced functions

Color

Use this key to toggle the monochrome and color scan modes.

- 1 Press [SCAN] on the control panel.
- 2 Press [e-mail], [Folder] or [FTP].
- 3 Press [Color].

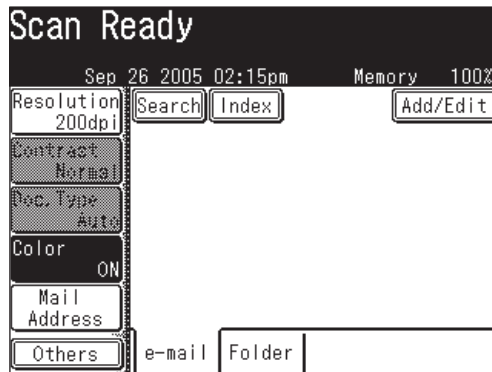

The color scan mode is now activated.

- 4 Press [Color] again to return to the monochrome scan setting.

Zoom

Use this function to reduce or enlarge the document image.

The available zoom ratio is as follows:

Zoon ratio	Resolution	ADF	Document glass
Range	300dpi, 600dpi	50-100%	50-200%
	200dpi	75-100%	75-200%
Preset ratio	300dpi, 600dpi	50%, 64%, 78%, 100%	50%, 64%, 78%, 100%, 121%, 129%, 154%
	200dpi	78%, 100%	78%, 100%, 121%

- NOTE:**
- For enlargement copy, you can only use the document glass (MFX-2030, MFX-1430 only).
 - This function is not available when scanning a color document.
 - You can assign [Zoom] to the soft key. See “Soft keys” on page 10-4.

- 1 Press [SCAN] on the control panel.
- 2 Press [e-mail], [Folder] or [FTP].
- 3 Press [Others].

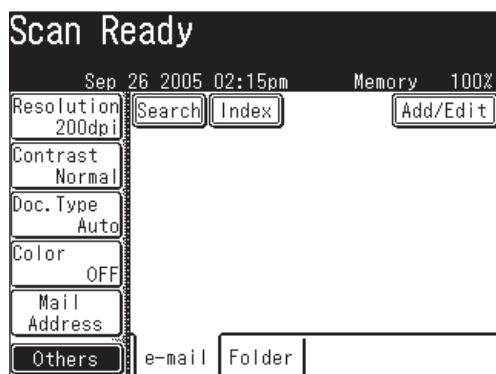

- 4 Press [Zoom].

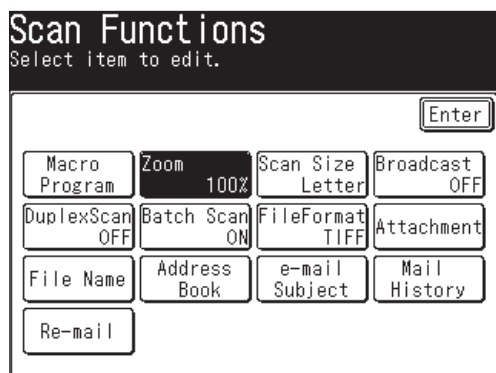

5 There are three ways to enter the zoom ratio.

Select a preset zoom ratio key.

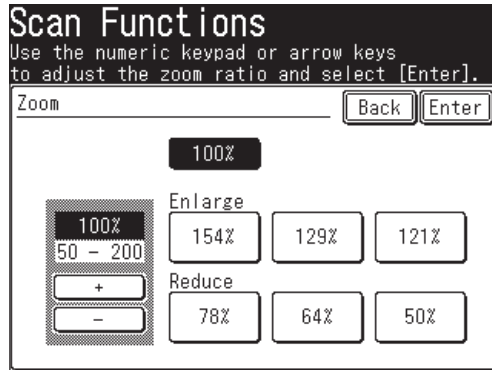

- 50%
- 64%: Letter (8.5" × 11") → Half-letter (5.5" × 8.5")
- 78%: Legal (8.5" × 14") → Letter (8.5" × 11")
- 100%
- 121% : Legal (8.5" × 14") → 11" × 17"
- 129% : Letter (8.5" × 11") → 11" × 17"
- 154% : Half-letter (5.5" × 8.5") → Legal (8.5" × 14")

– or –

Press [+] or [-] until your desired ratio is displayed.

(50 to 200% for the document glass, 50 to 100% for the ADF.)

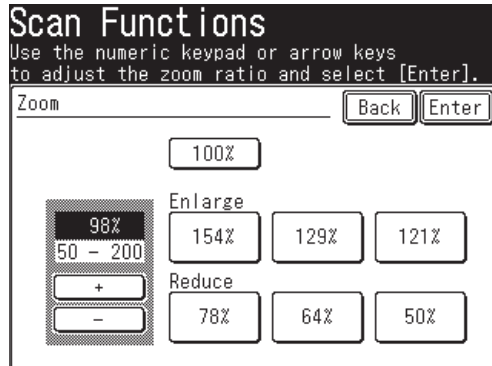

– or –

Enter your desired ratio using the numeric keys.

6 Press [Enter].

Batch scanning

When the “Batch Scan” function is on, it means that all scanned pages will be saved as one file. If you turn this function off, each scanned page will be saved as an individual file. Here is how:

- 1 Press [SCAN] on the control panel.
- 2 Press [e-mail], [Folder] or [FTP].
- 3 Press [Others].
- 4 Press [Batch Scan].

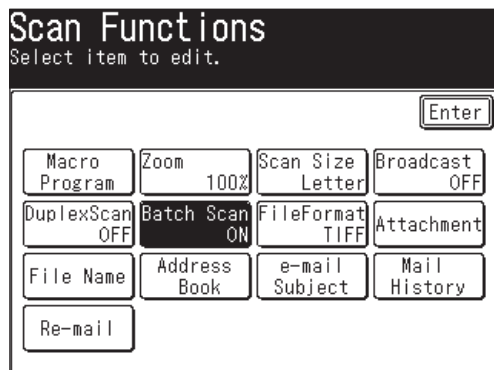

NOTE: You can assign [Batch Scan] to the soft key. See “Soft keys” on page 10-4.

- 5 Press [OFF].

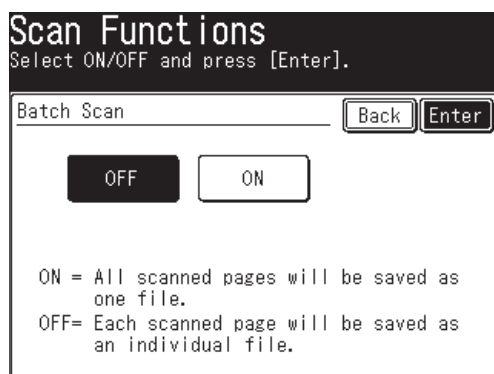

- 6 Press [Enter].

NOTE: If you are scanning color documents and select [JPEG] as the file format, batch scanning will not be possible. Each scanned page will be saved as an individual JPEG. If you select batch scan when sending documents to an e-mail address, all of the scanned pages will appear as individual files but they will be sent in one e-mail.

Selecting the file format

You can select the file format for the scanned document.

The following formats are available;

Monochrome documents: TIFF or PDF

Color documents: JPEG or PDF

- 1 Press [SCAN] on the control panel.
- 2 Press [e-mail], [Folder] or [FTP].
- 3 To scan color documents, press [Color] to toggle the key to [ON].
- 4 Press [Others].
- 5 Press [File Format].

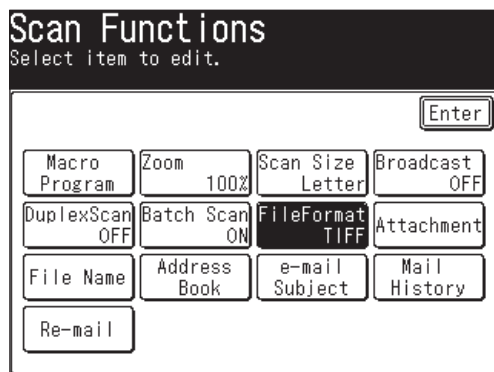

NOTE: You can assign [FileFormat] to the soft key. See "Soft keys" from page 10-2.

- 6 Select the desired file format.

This explanation shows the monochrome file format options. When color scan is activated, the settings for "Mono" are grayed out and the "Color" file formats are selectable.

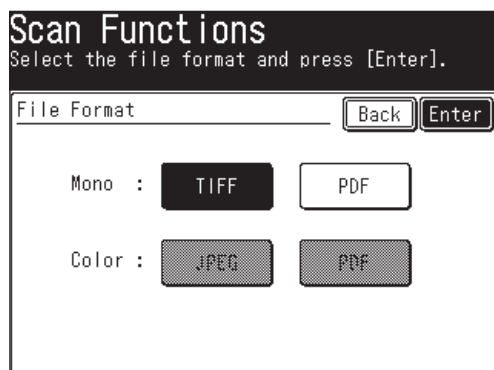

- 7 Press [Enter].

NOTE: You can change the default setting for [FileFormat]. See "Accessing the default scan settings" on page 12-7.

Duplex scanning

You can easily scan a two-sided document using this mode. Just load page one of the duplex document in the ADF and press [Start], the machine will prompt you on the following steps. The machine will automatically sort the pages into the correct order.

NOTE: To use this function, the document type should be set first. The illustration below shows the alternative binding type of the duplex document.



Top binding

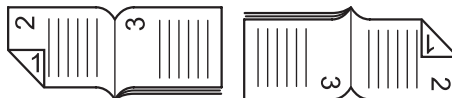

Right & Left binding

- 1 Set the document.
- 2 Press [SCAN] on the control panel.
- 3 Press [e-mail], [Folder] or [FTP].
- 4 Press [Others].
- 5 Press [DuplexScan].

NOTE: You can assign [DuplexScan] to the soft key. See “Soft keys” on page 10-4.

- 6 Select [ON].

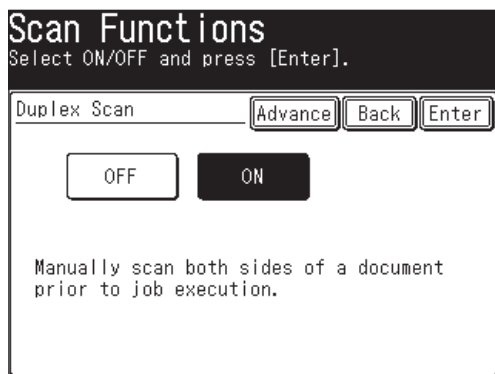

- 7 Press [Advance].

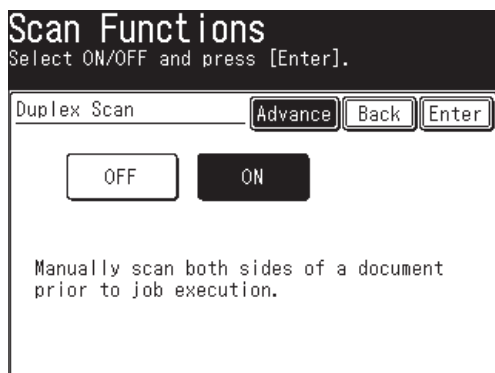

8 Press [Bind Right&Left].

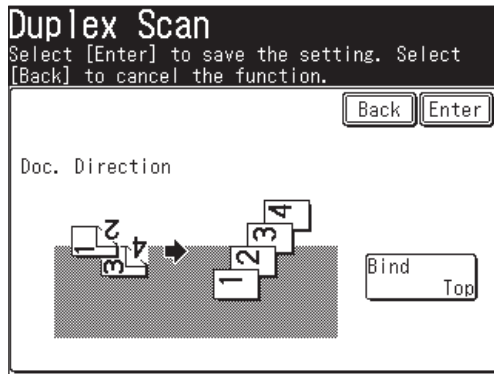

9 Select the binding position that suits your document.

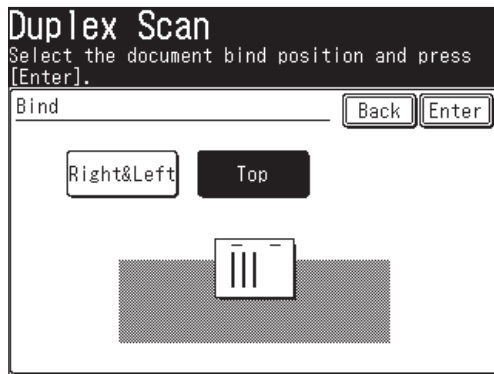

10 Press [Enter] three times.

11 Select the desired destination.

12 Press [Start].

13 After the first side has been scanned, remove the document(s) from the output tray and insert them in the same direction as before.

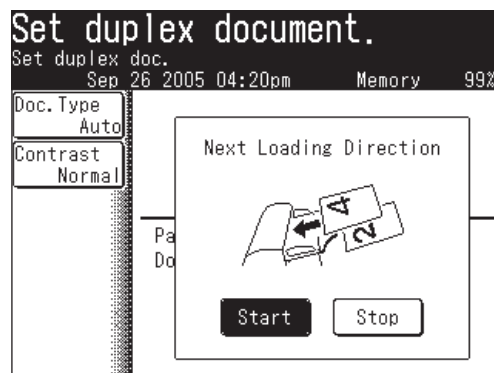

14 Press [Start] either using the key on the control panel or on the display. The machine will automatically sort the documents, you do not have to do this manually.

Broadcasting

Using this key, you can simultaneously send document to multiple destinations.

NOTE: Broadcasting is available for e-mail and folders or for FTP servers. You cannot broadcast a document to an e-mail address or a folder, and an FTP server together.

One broadcast can handle all 300 Address Book entries as well as 30 manually entered locations, for total of 330 locations. A broadcast can handle either 5 folder locations or 5 FTP servers.

- 1 Set the document.
- 2 Press [SCAN] on the control panel.
- 3 Press [e-mail], [Folder] or [FTP].
- 4 Press [Others].
- 5 Press [Broadcast] and toggle the switch to [ON].

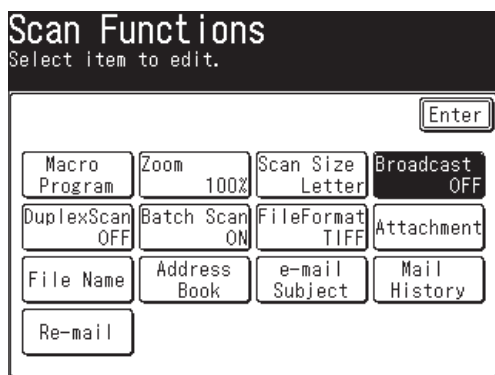

NOTE: You can assign [Broadcast] to the soft key. See "Soft keys" on page 10-4.

- 6 Press [Enter].
- 7 If you select a destination from address book or a folder/FTP shortcut, that location will be highlighted on the display.
- 8 To review or cancel a destination(s), press [Location]. If you want to cancel a destination(s), select the destination(s) you want to remove and press [Delete]. For more information about this display, see pages 5-23, 5-34 and 5-48.
- 9 When all the desired destinations are selected, press [Start].

Attaching additional files to the scanned document

In addition to the document you are scanning, you may add up to 10 network files (or up to 10 MB files worth of files) to the job.

To attach a file:

- 1 Press [SCAN] on the control panel.
- 2 Press [e-mail], [Folder] or [FTP].
- 3 Press [Others].
- 4 Press [Attachment].

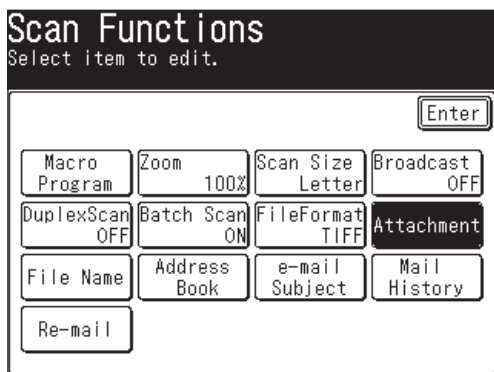

NOTE: You can assign [Attachment] to the soft key. See "Soft keys" on page 10-4.

- 5 After browsing, all accessible networks will be displayed.

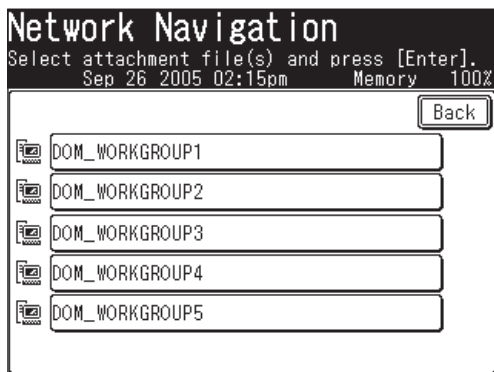

- 6 Select the network that contains your desired file. To scroll, use [Page Up] and [Page Down].

NOTE: The file should be under a shared folder that meets the following requirements:

- The folder should be in the same segment with your machine.
 - The shared folder name should contain 12 or characters less.
 - The link to the folder should contain 100 characters or less in length.
 - The link to the file should be 128 characters or less in length.
-

- 7 Search through the network folders until you find the folder in which the your desired file is.

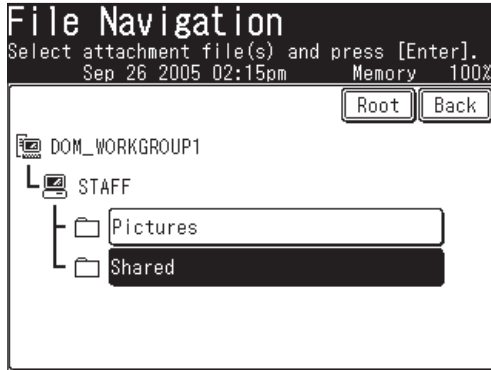

- To go up one step, press [Back].
 - To return to the first screen, press [Root].
- 8 If the user name and password are required to login to the file server, enter [UserName] and [Password].

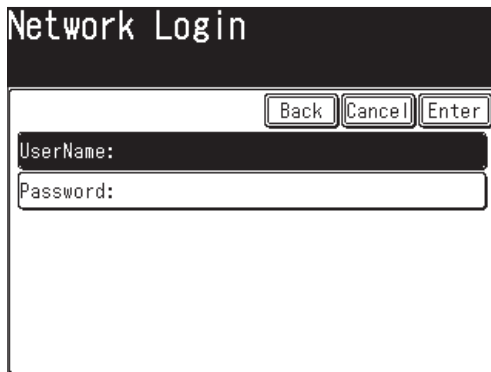

- Press [User Name], then enter the user name and press [Enter]. Refer to page 5-30 step 10 for more information.
 - Press [Password], then enter the password and press [Enter].
- 9 Select the file you want to attach by touching it (It will become highlighted).

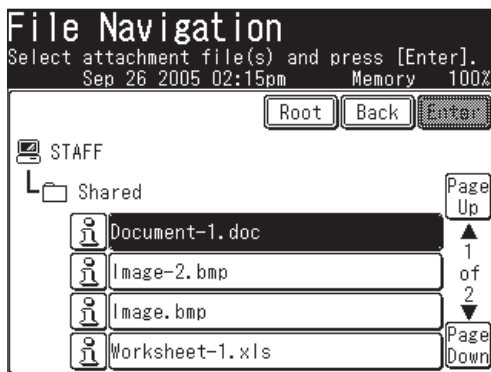

To review the document properties, press the  located next to the file.

- 10 Press [Enter].

- 11** To attach more files, press [Browse] and repeat steps 5 to 10. Otherwise proceed to step 12.

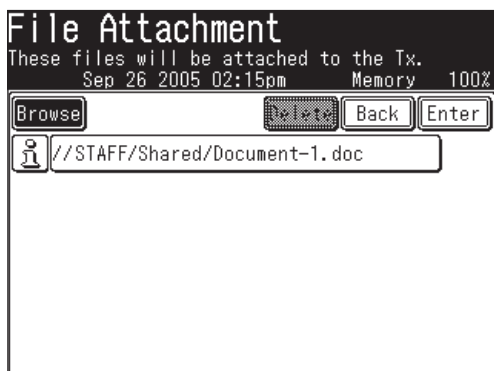

- 12** To remove attachments, select the file you want to remove and press [Delete].

- 13** Press [Enter].

Reviewing or canceling commands

Reviewing or canceling commands	6-2
To review or cancel a command	6-2
Reviewing or canceling parts of a broadcast	6-4
Printing a delayed command list	6-6
Printing a stored document.....	6-6
View or print the results of a fax transaction	6-8

Reviewing or canceling commands

Your machine can store several “Jobs” in memory. It also keeps track of each command by assigning it a command number, like “001.”

Delayed commands, redial attempts and current transactions are all stored in your machine’s memory and given a command number.

Your machine can store up to 100 delayed commands. It identifies each by a three-digit command number from 001 to 100.

The Review Commands function gives you the power to check on each job (or command) in your machine’s memory. It also allows you to cancel a fax and e-mail transmission command.

To review or cancel a command

The operation differs depending on whether or not a document is currently being transmitted.



- 1 Press [Fax Cancel/Job Confirm].
If your machine is attempting to perform a command, proceed to step 5.

NOTE: For details on canceling the group transmission and/or broadcast transmission in progress, refer to “Reviewing or canceling parts of a broadcast” on page 6-4.

- 2 Press [Delayed Commands].



- 3 The currently stored command will be displayed.

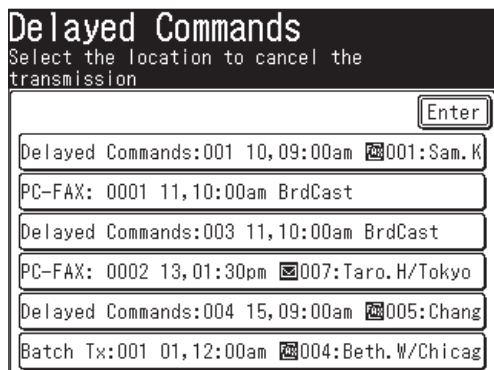

NOTE: [BrdCast] will be displayed for group transmission and broadcast transmission.

- 4 If you want to cancel a command, select the command you want to cancel.
The confirmation message will appear.
- 5 Press [Yes] to cancel the selected command. Otherwise, press [No].

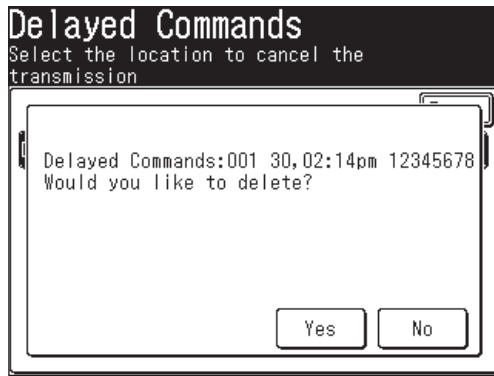

-
- NOTE:**
- If the selected command was being transmitted, communication will be canceled.
 - You can cancel the destinations for broadcast transmission individually when the broadcast command is in progress (See “Reviewing or canceling parts of a broadcast” on page 6-4).
-

- 6 To cancel other command, repeat procedures from step 4.
Press [Reset] to return to the standby mode.

Reviewing or canceling parts of a broadcast

You can also review or cancel certain destinations within a broadcast.

NOTE: When the broadcast command is in progress, you can cancel the destinations individually. However, you cannot cancel the destinations individually for the reserved command such as with delayed transmission.

(Reserved documents mixed with fax and e-mail for broadcast transmissions will have different commands for fax and e-mail respectively. In this case, you can only cancel one of the commands.)



- 1 Press [Fax Cancel/Job Confirm.], [Delayed Commands].



- 2 Select the command you want to cancel.

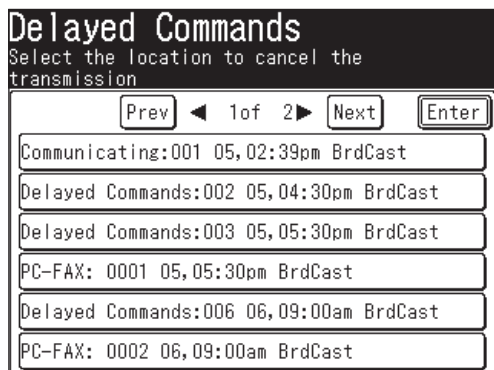

- 3 When the broadcast command you have selected is in progress, you can cancel the destinations individually.

Go to the next step without pressing [Yes].

Otherwise, go to the step 6.

- 4 To review or cancel the individual destinations within this broadcast, press [Detail].

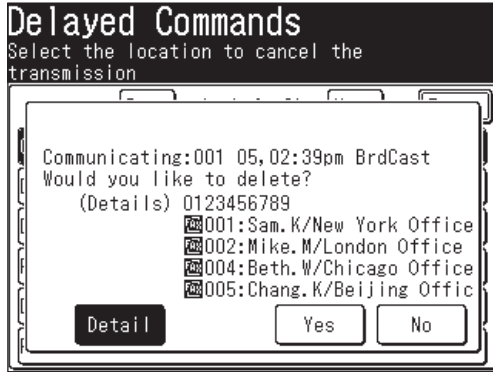

- 5 Press the destination you want to cancel.



- 6 Press [Yes].



If you want to cancel a different destination, go back to step 5.

If you want to go back to reviewing or canceling another command, press [Enter].

To stop reviewing or canceling commands, press [Reset].

Printing a delayed command list

Your machine can print a command list which shows the following:

- The command number, the batch transmission box number and the internet fax command number
- The phone number, the e-mail address and the address book number of the specified destination
- The start time (this appears in the DD,HH:MM format)
- The function specified for the command (ex. Broadcast, Batch transmission) will be printed in “Note”.

To print a delayed command list, press [Setting], [List], [Journal List], [Command List], then [Yes].

Printing a stored document

Your machine can print out documents stored for a delayed transmission.

- 1 Press [Setting].
- 2 Press [Store Doc Settings].
- 3 Press [Print].



- 4 Press [Command Doc.].

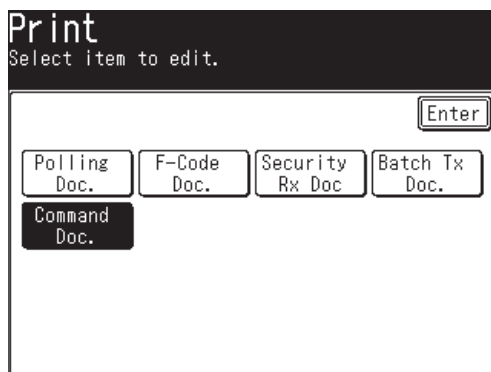

- 5 Press the command document you want to print.

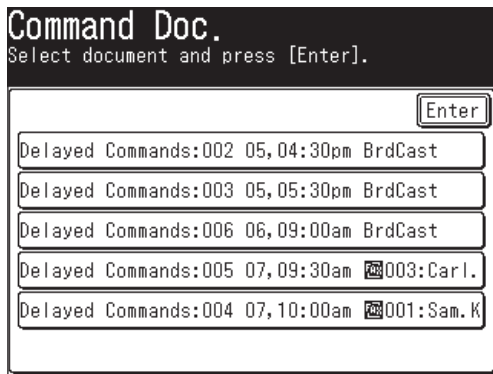

- 6 Press [Yes]. The selected command document will be printed.

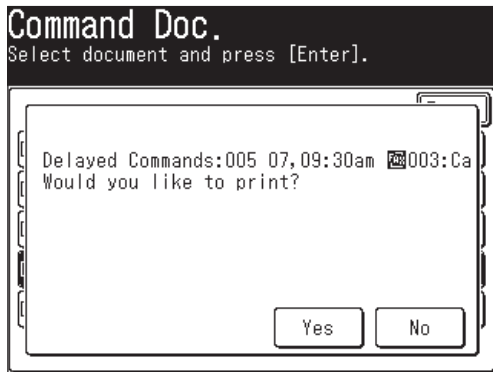

NOTE: The selected command document cannot be printed during a real time transmission or polling reception.

View or print the results of a fax transaction

The transaction history can display the past transactions. The results for each transaction can be also displayed and printed.



- 1 Press [Fax Cancel/Job Confirm].
- 2 (1) If a document is currently being transmitted, the following display will be shown.



Otherwise, proceed to step 4.

- (2) Press [No].

NOTE: Be sure to press [No] to keep the current transmission. If you press [Yes], the currently transmitting document will be canceled.

- 3 The Delayed Commands list will be displayed.
Press [Enter].
- 4 Press [Show History].
You can check the fax sending/receiving history, the mail sending history and the mail receiving history respectively.

Checking the fax sending/receiving history

The sending/receiving history for the last 100 fax jobs can be displayed.

- 5 Press [Show History].

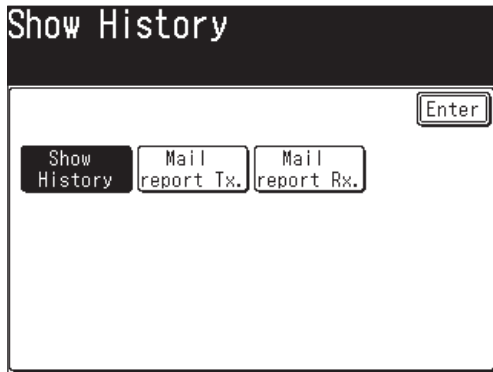

- 6 The fax sending/receiving history will be displayed.

- 7 Select the transaction you want to display.

The transaction results will be displayed.

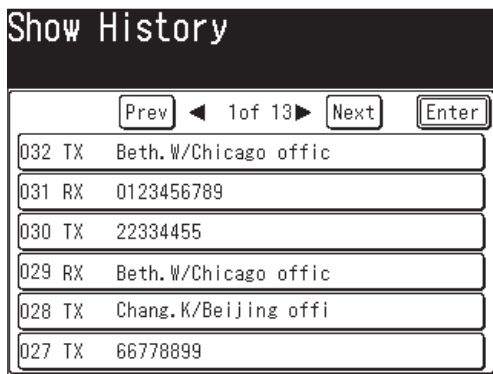

- 8 Press [Yes] to print the transaction results.

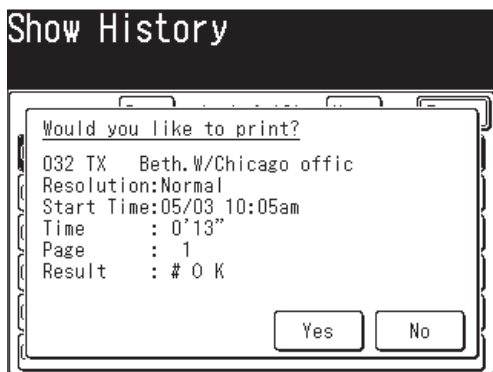

- NOTE:**
- Regarding the error code in "Result" column, see "Error codes" on pages 14-24 to 14-25.
 - In fax transaction results, "Tx Result" will be printed for fax transmissions, and "Rx Result" will be printed for fax receptions.

Checking the mail sending history

The transmission history for the last 50 Internet faxes and scan to e-mails can be displayed.

- 5 Press [Mail report Tx.].



- 6 The mail transmission history will be displayed.

- 7 Select the transaction you want to display.
The transaction result is displayed.

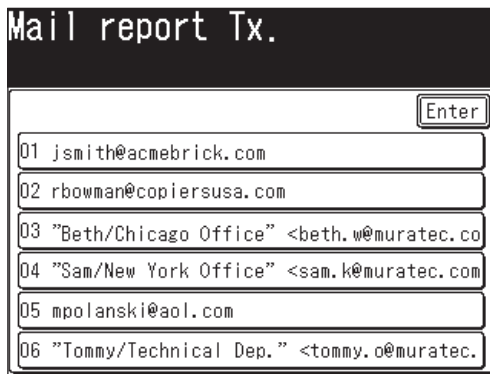

- 8 Press [Yes] to print the transaction results.

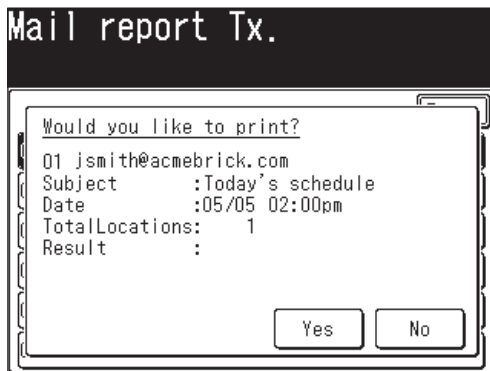

NOTE: Regarding the error code in "Result" column, see "Error codes" on pages 14-24 to 14-25.

Checking the mail reception history

The reception history for the last 50 Internet faxes and scan to e-mails can be displayed.

- 5 Press [Mail report Rx.].

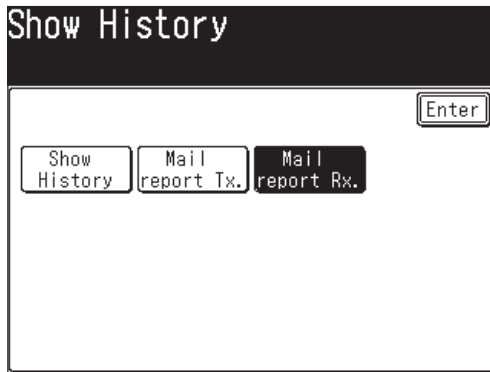

- 6 The mail reception history will be displayed.

- 7 Select the transaction you want to display.
The transaction result is displayed.

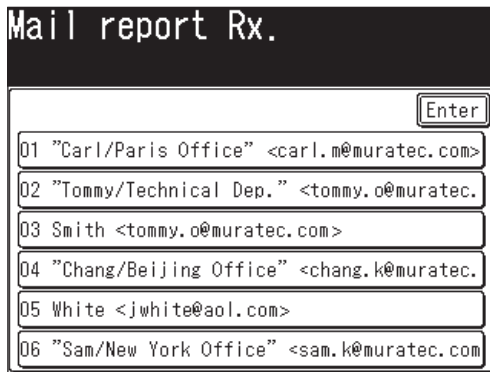

- 8 Press [Yes] to print the transaction results.

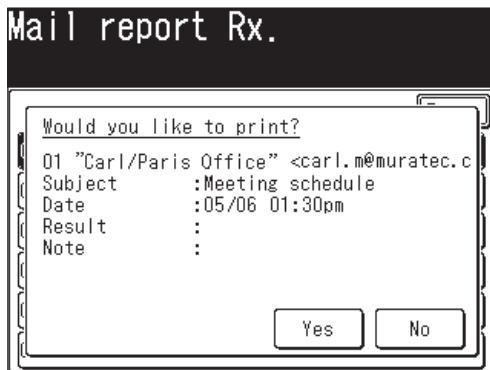

The transaction results will be printed.

NOTE: Regarding the error code in "Result" column, see "Error codes" on pages 14-24 to 14-25.

Chapter

7

Copying

Before copying	7-2
Document and paper handling.....	7-2
Memory overflow message.....	7-2
Making copies.....	7-3
Making copies	7-3
Setting the next document	7-3
Copying using both document glass and ADF.....	7-5
Copy reservation	7-7
Basic copy settings.....	7-8
Document type	7-8
Contrast.....	7-9
Number of copies.....	7-9
Advanced copy functions	7-10
Selecting the paper size.....	7-11
Zoom ratio	7-12
Automatic sorting	7-13
Combine.....	7-14
Duplex copy.....	7-16
Card Copy.....	7-25
Specifying the document size to copy	7-27
Checking the copy print queue.....	7-28

Before copying

Document and paper handling

Before you begin making copies, please read the information mentioned on pages 1-24 to 1-32.

Memory overflow message

If the memory overflows while scanning the first page

Press [Stop] to return to the standby mode.

→ Change the resolution or wait until memory becomes available before trying to copy again.

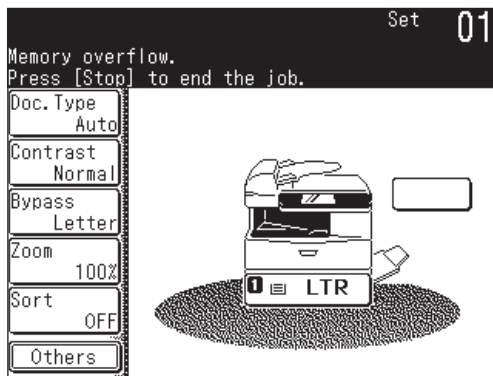

If the memory overflows while scanning page 2+

- Press [Yes] to copy the stored pages.
- Press [No] to cancel the copy job.

→ Change the resolution or wait until memory becomes available before trying to copy again.

NOTE: The following display is shown when the documents still remain.

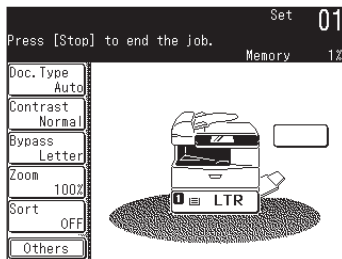

Press [Stop] to discharge the remaining documents.

Making copies

Making copies

- 1 Set the document. (See page 1-25)
- 2 Press [COPY] to display the Copy standby mode.
- 3 If necessary, adjust the copy settings. See “Basic copy settings” on page 7-8
To clear the settings, press [Reset].
- 4 Press [Start].
To stop copying, press [Stop].

Setting the next document

The next document can be set when performing Sort Copy (See page 7-13), Combined Copy (See page 7-14), Card Copy (See page 7-25) in order to scan a different document.

The default setting for this mode is [NO] when using the ADF, and [Yes] when using the document glass.

When using the ADF

- 1 Set the document in the ADF. (See page 1-25)
- 2 Set Sort Copy/Combine Copy.
- 3 Press [Start].

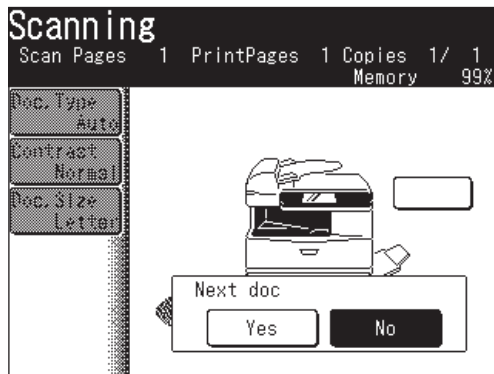

- 4 Press [Yes] while the document is being scanned.

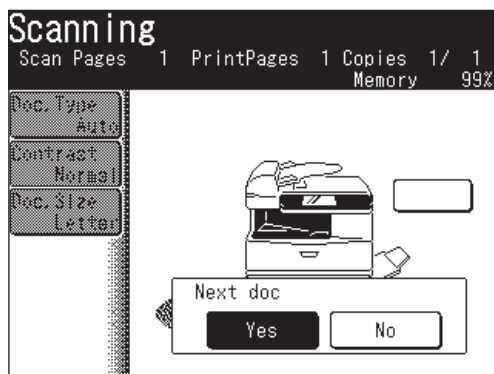

- 5 When the document has been scanned, set the next document.

- 6 Press [Next Doc]. The next document will be scanned.
 - The Next Doc setting can be deleted by pressing [Complete].
 - To scan another document, press [Yes] while the document is scanning.

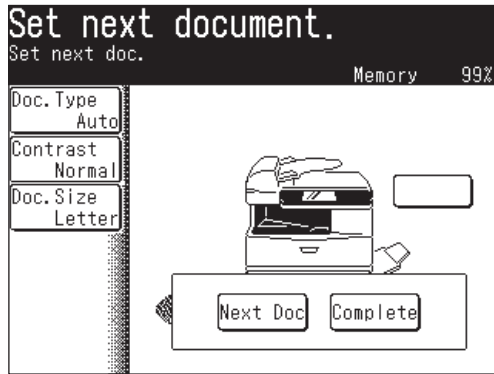

When using the document glass

- 1 Set the document on the document glass. (See page 1-25.)
- 2 Set Sort Copy/Combine Copy/ Card Copy.
- 3 Press [Start].

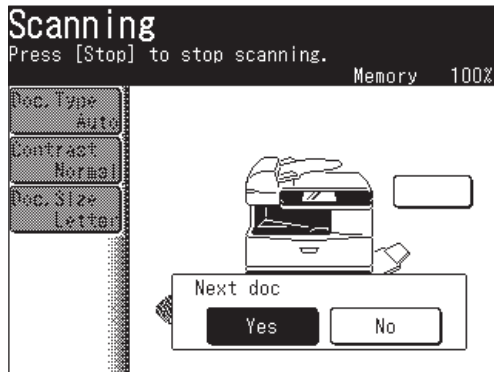

- Pressing [No] during document scanning will start the copying of all documents when the scan has been completed.
- 4 When scanning has been completed, set the next document (if a book, set the next page in place).

- 5 Press [Next Doc]. The next document will be scanned.

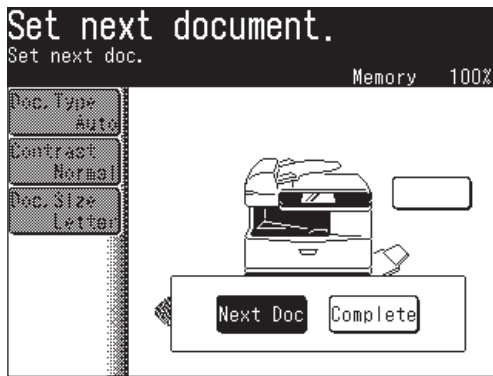

- 6 Press [Complete] when all the documents have been scanned.

Copying using both document glass and ADF

When the next document setting is activated you can make a copy using both the document glass and ADF.

- 1 Set the document in the ADF or on the document glass.
- 2 Set Sort Copy/Combine Copy.

NOTE: Card Copy cannot be used for Combine copy.

- 3 Press [Start].
- 4 When the document has been loaded into the ADF, press [Yes] during scanning.

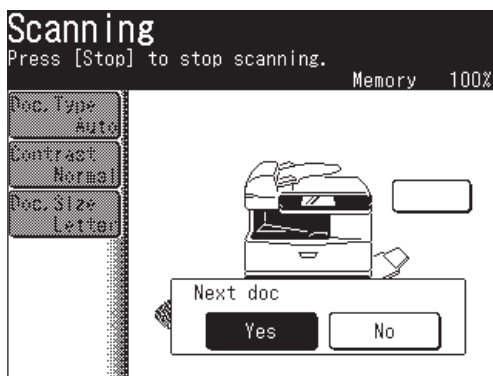

- 5 When scanning has been completed, set the next document.

NOTE: When a document is loaded in the ADF, remove the document from the document glass.

- 6 Press [Next Doc]. The next document will be scanned.
- Press [Complete] to begin copying.

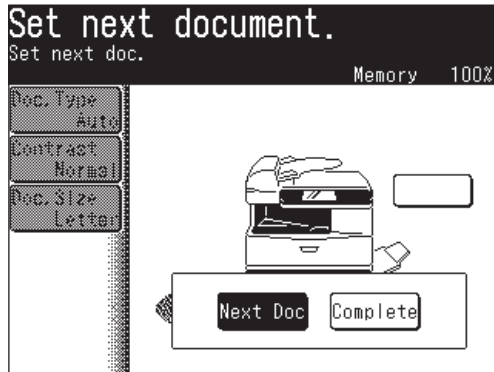

- 7 (1) When the document is scanned using the document glass, select the document size.
- (2) Press [Enter].



- 8 When the document is scanned using the document glass, press [Complete] to begin copying.
- When the document is scanned using the ADF, copying will begin automatically.

NOTE:

- To have the next document scanned, press [Next Doc] while the document is being scanned.
- The ADF's default setting is set to [Complete]. To scan the next document, select [Next Doc] while the current document is being scanned. For the document glass, the default setting is [Next Doc].
- Setting to [Complete] during scanning will begin copying of the scanned documents.

Copy reservation

A different document can be set and reserved for copying even while another copy is being printed. After the current job has been printed the next job will begin, meaning you won't have any downtime!

- 1 "Copy Reserve Ready" will be displayed while the job is printing.

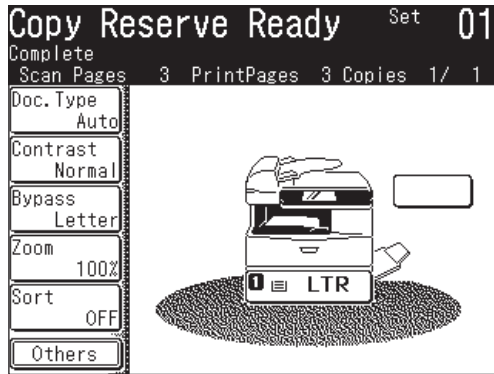

- 2 Set the document you want to reserve.
- 3 Adjust the copy settings. (See pages 7-8 to 7-9)
- 4 Press [Start].
- 5 Press [Yes] to perform copy reservation.
The document will be scanned and copying will begin after the current job has finished.

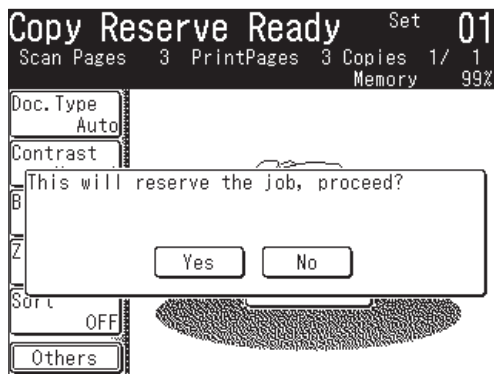

NOTE: The copy queue can be checked. (See page 7-28)

Basic copy settings

Document type

300 dpi or 600 dpi can be selected for [Text] and [Photo]. Refer to the table below and select the appropriate resolution. The default setting is [Auto].

Option	Document type	Resolution
Auto	Documents containing photographs or drawings with letters	300 dpi
Text	Documents with letters	300 dpi
Photo	Photographs or drawings	300 dpi
Text High-Res	Documents with letters	600 dpi*
Text&Photo High-Res	Documents containing photographs or drawings with letters	600 dpi*
Photo High-Res	Photographs or drawings	600 dpi*

* This resolution requires more memory. If you try to copy several pages at once, the memory may overflow.

To select the document type:

- 1 Press [Doc. Type].
- 2 Select the document type.

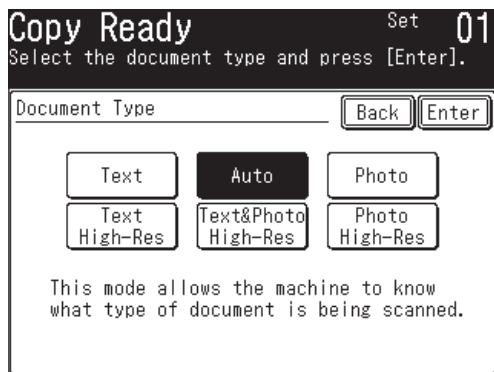

- 3 Press [Enter].

NOTE: You can change the default setting for [Doc.Type]. See "Accessing the copy settings" on page 12-3.

Contrast

You can lighten or darken the document pages you are copying.

To change the contrast setting:

- 1 Press [Contrast].
- 2 Select one of the contrast types.

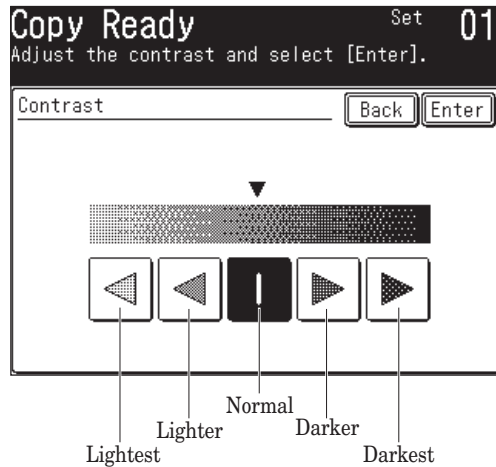

- 3 Press [Enter].

NOTE: You can change the default setting for [Contrast]. See “Accessing the copy settings” on page 12-3.

Number of copies

Each job can contain up to 99 copies.

Use the numeric keys to enter the desired number of copies (01-99).

Advanced copy functions

The table below lists the advanced functions that can be used in the Copy mode.

To select the advanced copy functions:

- 1** Press [COPY] to display the Copy standby mode.
- 2** Press [Others].
- 3** Press the key you want to select.

Refer to the pages indicated for detailed information.

NOTE: You can assign a function that you frequently use to a soft key for instant recall. (See pages 10-2 to 10-6.)

Advanced function	Descriptions	Reference Page
Bypass	Use this to set the paper type on the bypass tray.	p. 1-32
Zoom	Use this to set the magnification for zoom copy.	p. 7-12
Sort	Enable or disable the sort copy.	p. 7-13
Combine	Enable or disable the combine copy.	p. 7-14
Duplex Copy ^{*1}	Enable or disable the duplex copy.	p. 7-16
Doc.Size	Specify the size of the document to be copied.	p. 7-27
Card Copy ^{*2}	Enable or disable the card copy.	p. 7-25

^{*1} The duplex printing unit is required. [Duplex Copy] is displayed when the duplex printing unit is not installed.

^{*2} Card Copy is available from document glass only. This function is not available for F-560/F-520.

Selecting the paper size

The machine will automatically select the appropriate paper to match the original document, however you can manually specify the paper all well.

In addition, bypass copy is available using the bypass tray.

Selecting the paper

From the display, select the cassette containing the paper you want to use for copying.

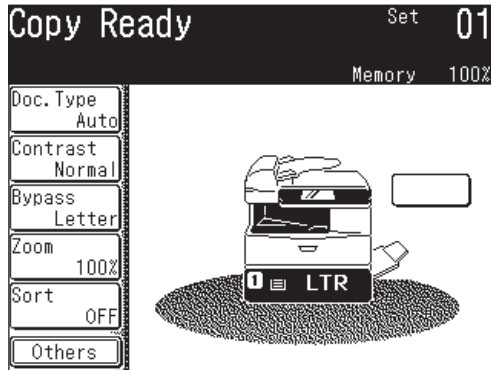

- For bypass copy, use the following procedure to set the paper type.

1 Press [Bypass].

Press [Others], [Bypass] for MFX-2030/MFX-1430 model.

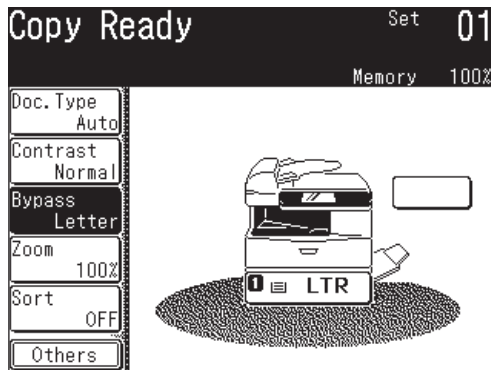

2 Select the paper type you want to use for copying.

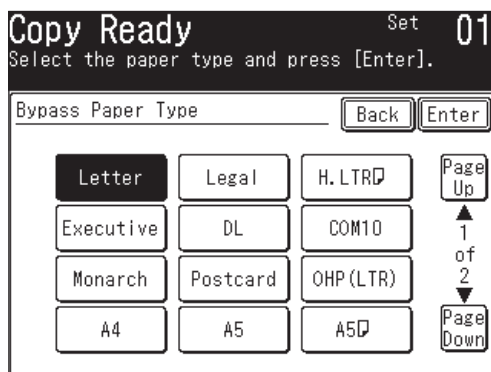

3 Press [Enter].

Zoom ratio

This machine allows you to reduce the image you are copying.
There are three ways to enter the zoom ratio.

Using preset ratios

- 1 Press [Zoom].
- 2 Select the following preset ratio.

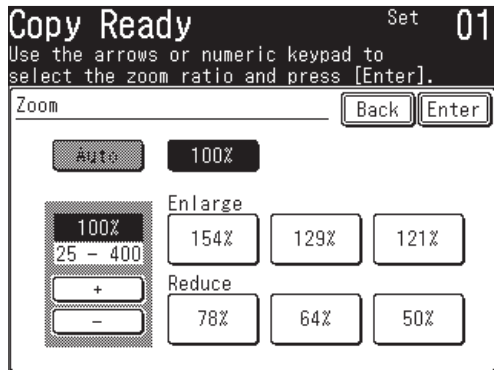

- 50%: Min.
- 64%: Letter (8.5" × 11") → Half-letter (5.5" × 8.5")
- 78%: Legal (8.5" × 14") → Letter (8.5" × 11")
- 100%
- 121% : Legal (8.5" × 14") → 11" × 17"
- 129% : Letter (8.5" × 11") → 11" × 17"
- 154% : Half-letter (5.5" × 8.5") → Legal (8.5" × 14")

NOTE: For enlargement copy, you can only use the document glass.

- 3 Press [Enter].

Adjusting the ratio 1% increments

- 1 Press [Zoom].
- 2 Adjust the ratio by using [+] or [-].
(You can set the magnification from 25 to 100% for the ADF, from 25 to 400% for the document glass.)
- 3 Press [Enter].

Manually enter the ratio

- 1 Press [Zoom].
- 2 Use the numeric keys to enter your desired ratio.
(You can set the magnification from 25 to 100% for the ADF, from 25 to 400% for the document glass.)
- 3 Press [Enter].

Automatic sorting

Copy jobs can be collated into individual sets, meaning they are ready for office distribution.

To enable/disable automatic sorting:

[ON] and [OFF] toggle every time you press [Sort].

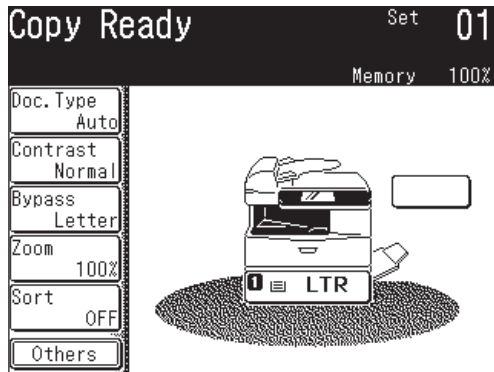

NOTE: You can change the default setting for [Sort]. See “Accessing the copy settings” on page 12-3.

Combine

Multiple originals can be copied into an arrangement on one sheet of paper.

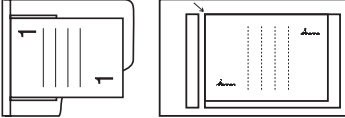
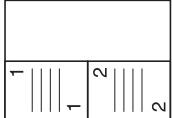
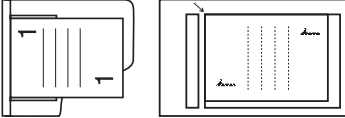
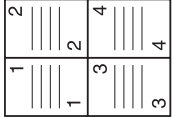
Document orientation on the ADF or document glass	Result image of combined copy
<ul style="list-style-type: none"> In case of 2-in-1 	
<ul style="list-style-type: none"> In case of 4-in-1 	

NOTE:

- For enlargement copy, you can only use the document glass.
- This machine does not have an image rotation function.

- 1 Set the document.
- 2 Press [COPY] to display the Copy standby mode.
- 3 Press [Others], [Combine].

NOTE: You can assign [Combine] to the soft key. See “Soft keys” on pages 10-2 to 10-6.

- 4 Select the number of document to be combined on to one sheet of paper.

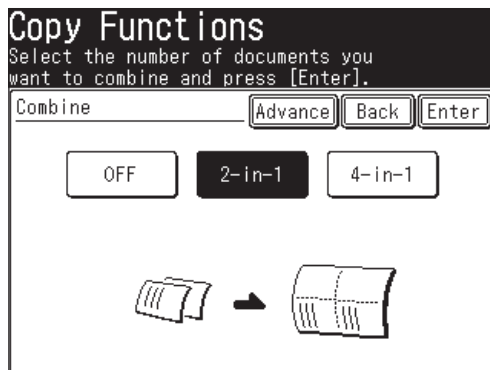

- When you set an advanced function, proceed to step 5.
 - When you do not set an advanced function, proceed to step 8.
- 5 Press [Advance].

Selecting the paper

- 6 (1) When selecting the paper, press [Paper].
(2) Select the paper.

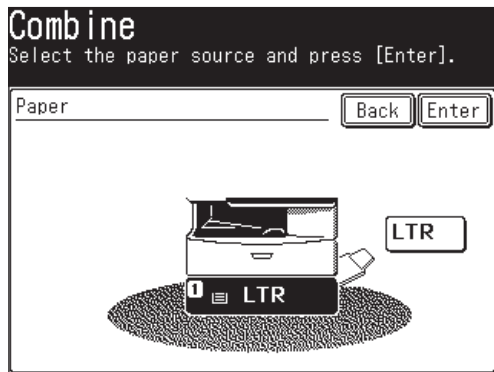

- (3) Press [Enter].

Setting the magnification

The magnification is automatically set. However you can change the copy magnification in the following steps.

- 7 (1) Press [Ratio] to change the copy magnification.
(2) Select a preset ratio, use [+] [-] or the numeric keypad to set the magnification.

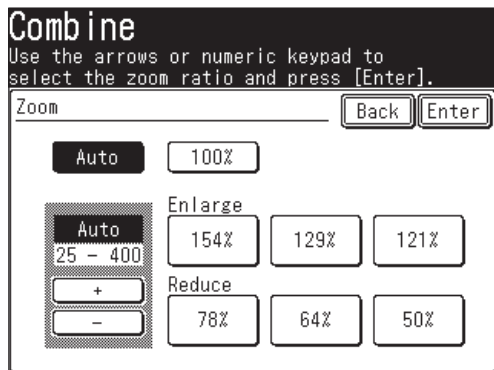

- The magnification can be set from 25% to 100% for the ADF, from 25% to 400% for the document glass.

- (3) Press [Enter].
- 8 Press [Enter] twice to return to the standby mode.
- 9 Set the document and press [Start].

NOTE: Press [Reset] to cancel the combine copy settings.

Duplex copy

You can use this function to perform:

- **One-sided copying of a duplex document (2:1)** (See page 7-19)

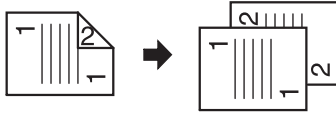

- **Duplex copying of a duplex document (2:2)*** (See page 7-21)



- **Duplex copying of a one-sided document (1:2)*** (See page 7-23)

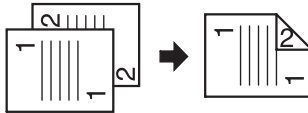

* The duplex printing unit is required.

	Binding position	Document orientation	Result image of duplexed copy
2→ 1 sided	R&L* ¹		
	Top* ¹		
	R&L* ¹		
	Top* ¹		

*1 The front and backside of the document must be in the same direction.

	Binding position	Document orientation	Result image of duplexed copy
2→ 2 sided	R&L ^{*2}	<ul style="list-style-type: none"> • When you place the front side • When you place the backside 	
	Top ^{*1}		
	R&L ^{*1}		
	Top ^{*2}	<ul style="list-style-type: none"> • When you place the front side • When you place the backside 	
1→ 2 sided	R&L		
	Top		
	R&L		
	Top		

*1 The front and backside of the document must be in the same direction.

*2 The front side and the backside are set in different directions.

NOTE: • Enlargement copy is only available when you perform the duplex copy (1:2) of one-sided documents using the document glass.

• This machine does not have an image rotation function.

How to bind copied documents

The document can be bound on the left side, right side or top.

Right or left binding

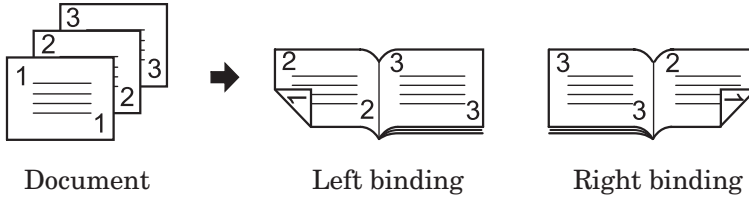

- Select these when binding on the right or left side of the copy.

Top binding

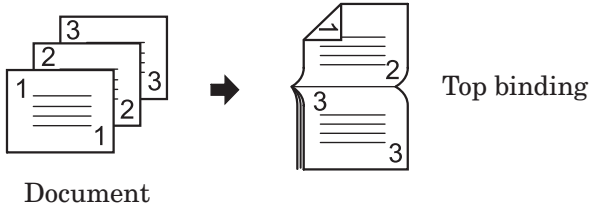

- Select this when binding on the top side of the copy.

One-sided copying of a duplex document (2:1)

This mode allows you to convert two-sided originals into one-sided documents.

- 1 Scan the front side.
- 2 Turn over the document and scan the backside.
- 3 The scanned data temporarily saved in the memory will be sorted and printed.

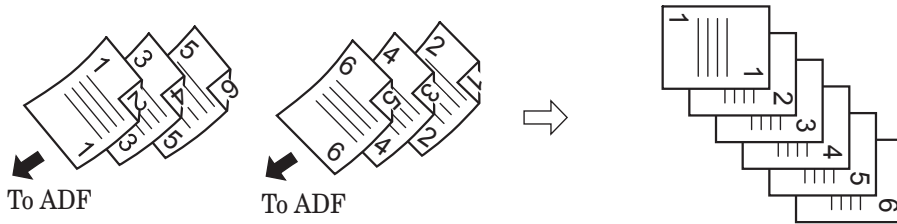

NOTE: When the power fails due to such as blackout during one-sided copying of duplex document, see as follows:

- While sorting the scanned data:
The scanned data temporarily saved will not be saved in memory.
- When sorting the scanned data is completed:
The scanned data temporarily saved will be saved in memory.

- 1 Set the front side of the duplex document in the ADF.
- 2 Press [COPY] to display the Copy standby mode.
- 3 Press [Others], [DuplexCopy]*.
* If the duplex printing unit is not installed, press [DuplexScan].

NOTE: You can assign [DuplexCopy] (or [DuplexScan]) to the soft key. See “Soft keys” on pages 10-2 to 10-6.

- 4 Press [2 -> 1 sided]*.
* If the duplex printing unit is not installed, press [ON].

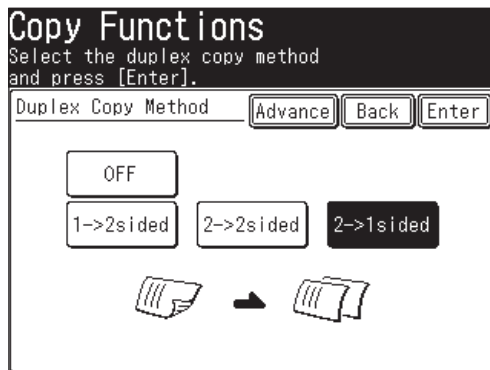

- If you set an advanced functions proceed to step 5.
 - If you do not set an advanced function, proceed to step 7.
- 5 Press [Advance].

- 6 (1) Press [Bind] to set the document bind position.
 - Press [DuplexCopy]* to return to the duplex copy display.
 - * Not displayed if the duplex printing unit is not installed.

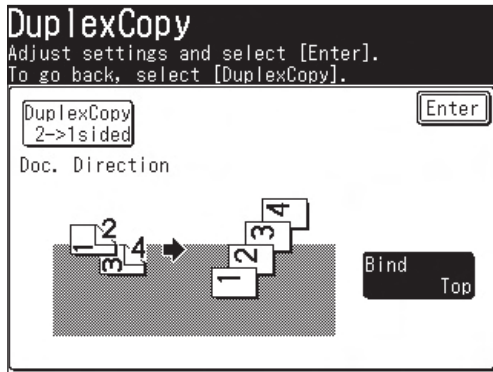

- (2) Press [Right&Left] or [Top].

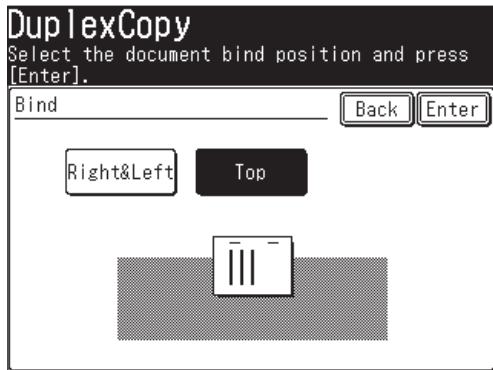

- (3) Press [Enter].

- 7 Press [Enter] twice to return to the standby display. Press [Reset] to cancel the duplex copy settings.
- 8 Press [Start]. The front side of the duplex document will be scanned.
- 9 When the following display is shown, place the backside of the duplex document in the same direction as the front side and press [Start].
 - Press [Stop] to cancel.
 - Be sure to set the document in the correct direction. (See the table on page 7-16.)

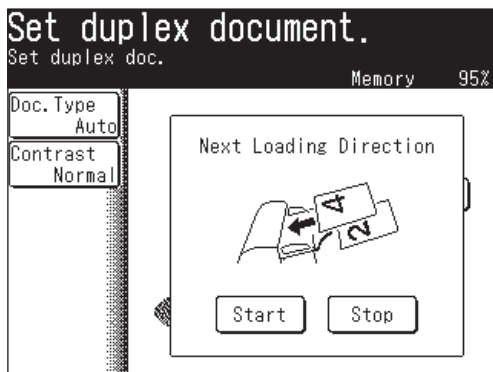

Duplex copying of a duplex document (2:2)

This mode will convert two-sided originals into two-sided documents.

* The duplex printing unit is required.

- 1 Set the front side of the duplex document in the ADF.
- 2 Press [Copy] to display the Copy standby mode.
- 3 Press [Others], [DuplexCopy].

NOTE: You can assign [DuplexCopy] to the soft key. See “Soft keys” on pages 10-2 to 10-6.

- 4 Press [2 -> 2 sided].

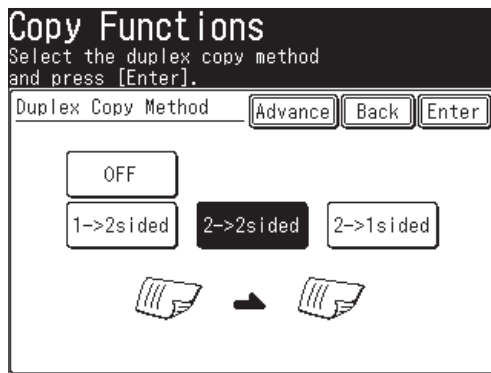

- If you set an advanced function, proceed to step 5.
- If you do not set an advanced function, proceed to step 7.

- 5 Press [Advance].

- 6 (1) Press [Bind] to set document bind position.
 - Press [DuplexCopy] to return to the duplex copy display.

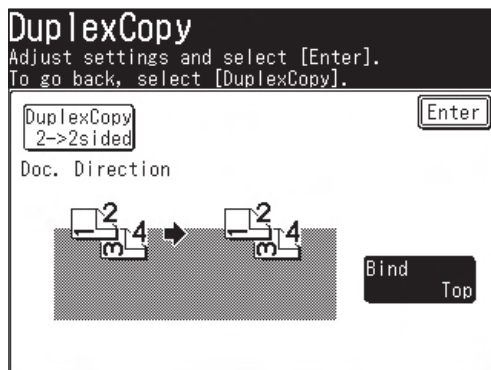

(2) Press [Right&Left] or [Top].

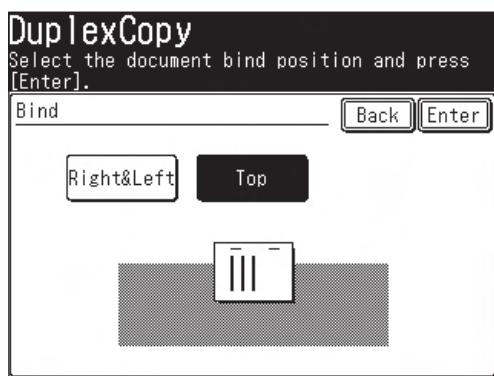

(3) Press [Enter].

7 Press [Enter] twice to return to the standby mode.
Press [Reset] to cancel the duplex copy settings.

8 Press [Start].
Scan the front side of the duplex document.

9 When the following display is shown, set the document in the correct direction and press [Start]. (See the table on page 7-17.)

- Press [Stop] to cancel.
- Be sure to set the document in the correct direction. (See the table on page 7-17.)

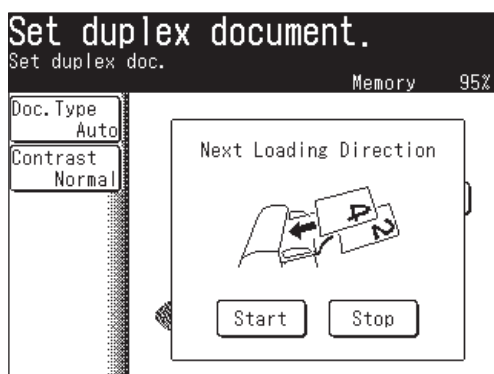

Duplex copying of a one-sided document (1:2)

* The duplex printing unit is required.

- 1 Set the document.
- 2 Press [COPY] to display the Copy standby mode.
- 3 Press [Others], [DuplexCopy].

NOTE: You can assign [DuplexCopy] to the soft key. See “Soft keys” on pages 10-2 to 10-6.

- 4 Press [1 -> 2 sided].

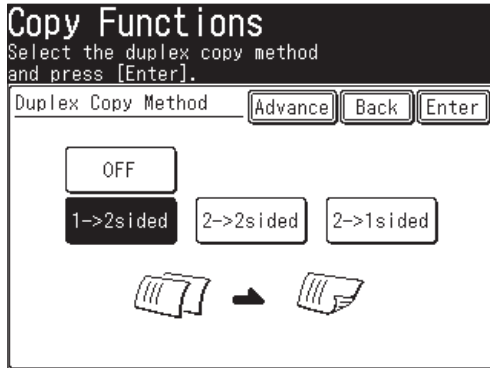

- If you set an advanced function, proceed to step 5.
- If you do not set an advanced function, proceed to step 7.

- 5 Press [Advance].

- 6 (1) Press [Bind] to set the binding position.
 - Press [DuplexCopy] to return to the duplex copy display.

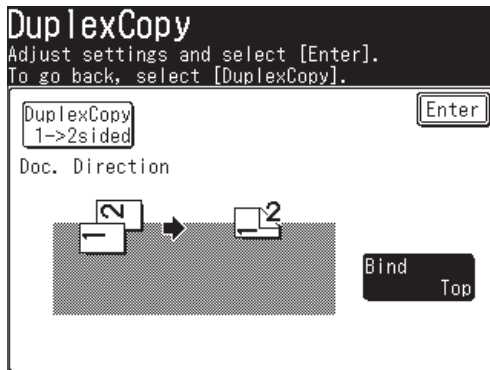

(2) Press [Right&Left] or [Top].

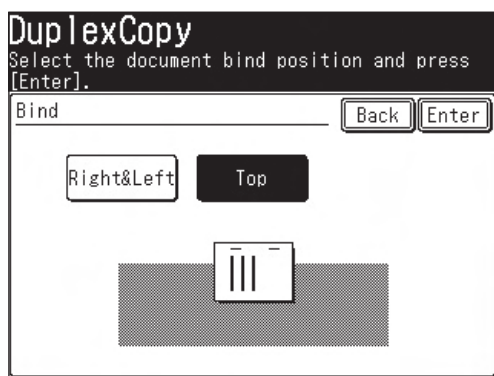

(3) Press [Enter].

7 Press [Enter] twice to return to the standby mode.
Press [Reset] to cancel the duplex copy settings.

8 Press [Start].

9 Press [Yes] while the document is being scanned.

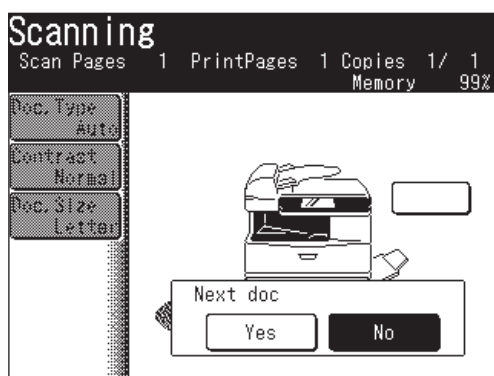

Selecting [No] will cause one-sided document output.

10 After the document has been scanned, set the next document.

11 Press [Next Doc].

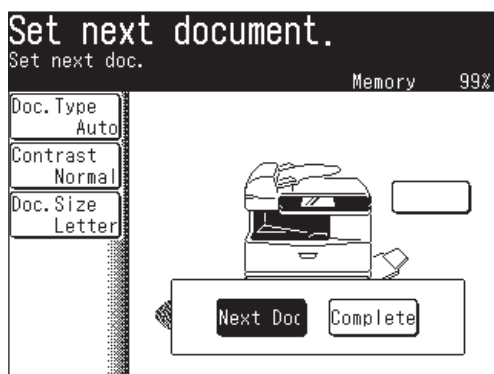

- The Next Doc setting can be deleted by pressing [Complete].
- To scan another document, press [Yes] while the document is being scanned.

Card Copy

The front and back of an id card or check-sized original can be copied onto one sheet of paper by using the document glass. Two id card-sized originals can be also copied at the same time.

	Document orientation	When copied onto paper <input type="checkbox"/>	When copied onto paper <input checked="" type="checkbox"/>
Card			
Card x 2			
Personal Check			
Business Check			

- NOTE:**
- Copying can be done with the platen cover open. Avoid looking at the light while copying. Looking at the light could cause eye damage.
 - Card Copy is available only from the document. This function is not available for F-560/F-520.

- 1 Set the card or check on the document glass.
- 2 (1) Press [Copy] to display the copy standby mode.
(2) Press [Card Copy].

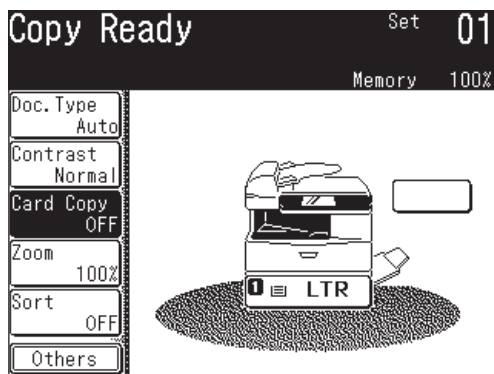

- (1) Select the type of object you want to copy.
- (2) Press [Advance].

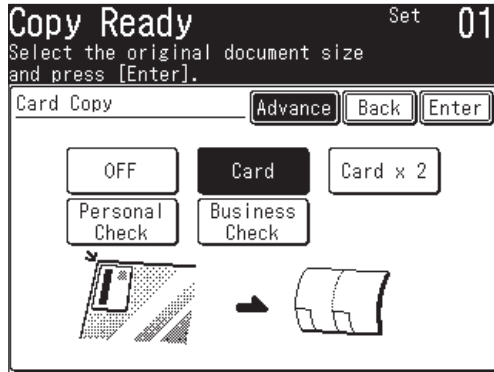

- (1) Press [Paper] to select the paper.
 - You can change the type of object by pressing [Card Copy].

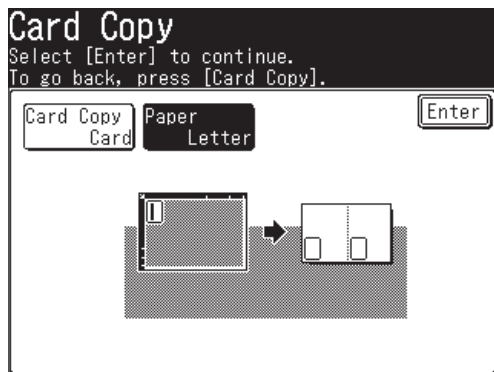

- (2) Press [Enter] twice.

- Press [Start].
- Once scanning has completed, turn over all of the placed originals and press [Next Doc].
 - The Next Doc setting can be deleted by pressing [Complete].

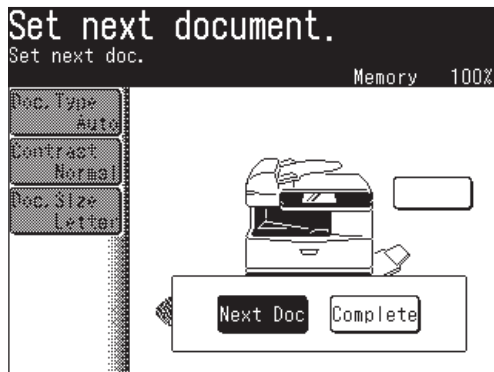

Specifying the document size to copy

If the document size exceeds the size set, only the default scan range will be copied. To insure that your job is scanned properly, please adjust the scan range.

- 1 Set the document.
- 2 (1) Press [COPY] to display the Copy standby mode.
(2) Press [Others].
- 3 Press [Doc.Size].

NOTE: You can assign [Doc.Size] to the soft key. See “Soft keys” on pages 10-2 to 10-6.

- 4 (1) Select the size of the document to be copied.

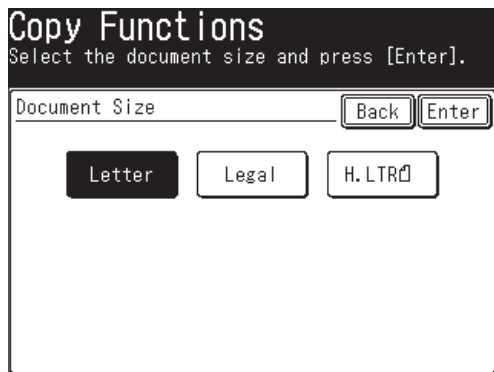

- (2) Press [Enter] twice.
- 5 Press [Start].

Checking the copy print queue

If a job is scanned while another job is printing, that job will be reserved in the copy print queue.

The copy will be printed based on the order in which it was scanned.

In addition, if the toner or paper runs out while copying, copy reservation can be used in the same way if the job has not been completed.

- 1 Press [Setting], [Management], [Next], [Display Jobs in Queue].

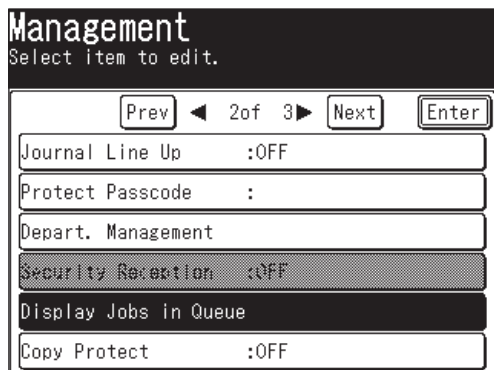

- 2 Press [Reserved Copy].

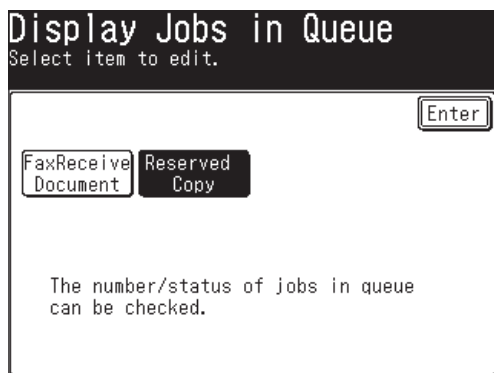

- 3 This shows the jobs currently in the queue. Press [Reset] to return to the standby mode.

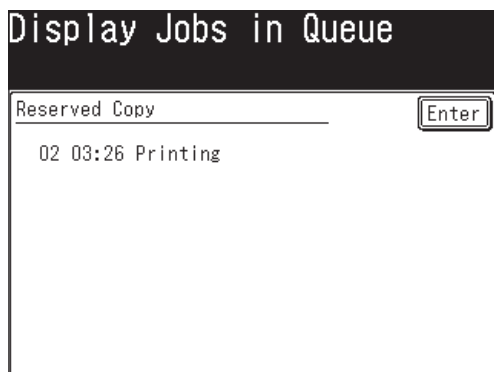

Chapter

8

PC-Fax function

Installing the driver.....	8-2
Sending a PC fax.....	8-3

You can send a document from a PC application to a remote fax machine or e-mail location:

This process allows you to save time and reduce the paper consumption in your office.

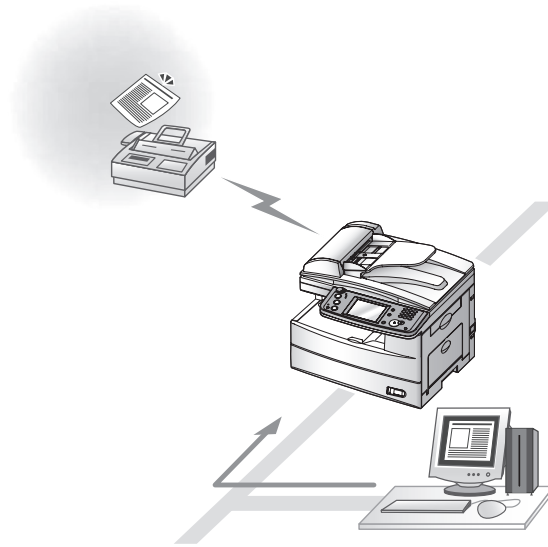

Installing the driver

In order to perform a PC fax, you need to have the PC-FAX driver installed on your PC.

The PC-FAX driver is located on the CD supplied with your machine. For more information on how to install the driver, refer to the “Network Printer Manual” located on the CD.

Sending a PC fax

After the PC-FAX driver is installed on your PC, you can send a document directly from your PC to a remote fax machine or e-mail inbox.

The following steps provide the basic procedure for sending a PC fax.

- 1 Verify that your machine is properly connected to the computer and the power has been turned on.
- 2 Verify that you have installed the fax driver on your computer.
- 3 Start the desired application program and create/open a document.
- 4 Click [Print] from the **File** menu.

Make sure that “Muratec *** Fax” is selected as the printer. (***) indicates your machine’s model name, ex. “Muratec F-520 FAX”.)

If you want to make any adjustments, click [Properties]. For details, refer to the “Network Printer Manual” on the CD supplied with your machine.

- 5 Click [Print].

The “Fax Transmission Settings” dialog will appear.

NOTE: To display the “Fax Transmission Settings”, a Web browser such as Microsoft Internet Explorer should be installed on your computer.

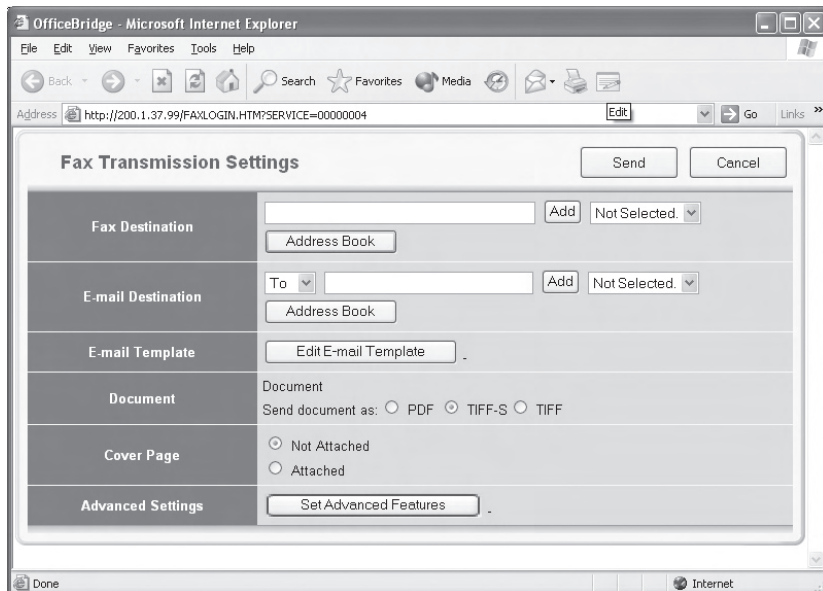

- 6 Specify the destination and click [Send].

NOTE: For more information on PC faxing, refer to the “Network Printer Manual” on the CD supplied with your machine.

Chapter

9

PC printing

Installing the driver	9-2
Printing a document from the PC	9-3

Your machine can be used as a printer, either locally through the USB port or through the network via the Ethernet port.

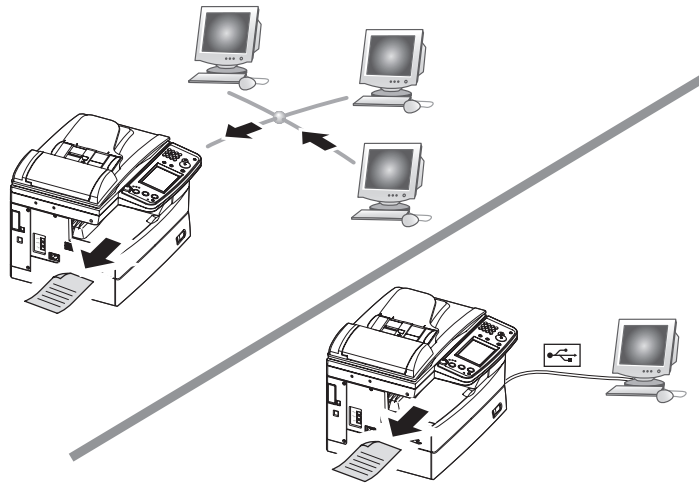

Installing the driver

In order to use your machine as a local or network printer you should have the applicable print driver installed on your PC.

The drivers are located on the CD supplied with your machine. The CD also contains “Local Printer and Scanner Manual” and “Network Printer Manual”, please refer to these guides for the installation instructions.

Printing a document from the PC

After the network or local print driver is installed on your PC, you can printout documents from virtually any PC application.

The following steps describe the typical process when printing documents out of Windows-based applications. The exact process may vary depending on the application you are using.

- 1** Verify that your machine is properly connected to the computer, the power has been turned on and the cassette is full of paper.
- 2** Verify that you have installed the print driver on your computer.
- 3** Start the desired application program and create/open a document.
- 4** Click [Print] or [Print Setup] from the **File** menu.
Make sure that “Muratec ***” is selected as the printer. (***) indicates your machine’s model name, ex. “Muratec F-520”.)
If you want to make any adjustments, click [Properties] or [Setup].
- 5** Click [OK] or [Print] to start the print job.

NOTE: For more information on printing, refer to the “Local Printer and Scanner Manual” and “Network Printer Manual” on the CD supplied with your machine.

Chapter

10

Special features

Soft keys	10-2
Soft key functions	10-2
Programming a soft key	10-5
Macro keys.....	10-7
Registering or editing a Macro.....	10-7
Deleting a Macro key.....	10-10
Changing the Macro key speed.....	10-11
Editing macro key titles	10-12
Executing a Macro command.....	10-13
Program one-touch.....	10-14
Registering or editing a program one-touch.....	10-14
Deleting a program one-touch.....	10-19
How to use a program one-touch	10-20
F-code box feature.....	10-21
F-code introduction.....	10-21
Registering or editing an F-code box	10-21
Printing a list of F-code boxes.....	10-30
Printing a list of documents stored in F-code boxes	10-30
Deleting an empty F-code box.....	10-30
Storing a document in a bulletin box.....	10-31
Printing stored documents	10-33
Deleting stored documents.....	10-35
Sending a document using a subaddress and password.....	10-37
Polling a document using a subaddress and password.....	10-38
Viewing the page counters.....	10-39
Checking the number of printed pages	10-39

Soft keys

The soft key is a shortcut key. By assigning frequently used functions to a soft key you can perform instant recall of this feature. The five soft keys can be displayed on the standby mode.

You can program the soft keys for the copy, fax and scanner displays. Also, the fax and scanner displays have multiple tabs on the bottom of the display that toggle between fax, e-mail, folder etc. Each of these tabs can contain its own set of soft keys.

Example of Copy standby mode

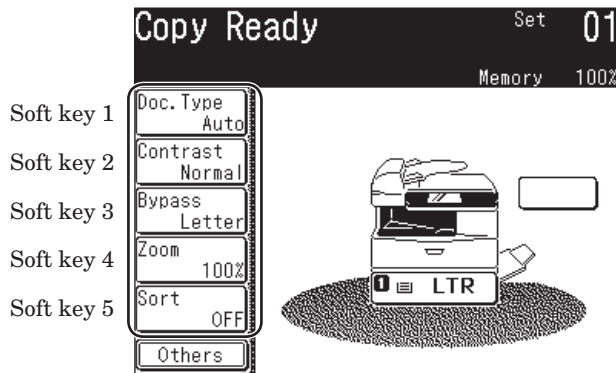

Soft key functions

The following table lists the functions you can assign to a soft key.

Copy mode

Function name	Descriptions	Reference page
Macro Program	Use this to perform the macro program.	p.10-7
Doc.Type	Use this to set the document type and resolution for copying.	p.7-8
Contrast	Use this to set the contrast for copying.	p.7-9
Card Copy *1	Use this to set the card copy.	p.7-25
Zoom	Use this to set the magnification for copying.	p.7-12
Sort	Makes on/off setting for sort copy.	p.7-13
Combine	Use this to set the combine copy.	p.7-14
Duplex Copy *2	Use this to set the duplex copy.	p.7-16
Doc. Size	Use this to select the size of the document to be copied.	p.7-27
Bypass	Use this to set the paper type on the bypass tray.	p.7-11

*1: This function is for MFX-2030/MFX-1430 only.

*2: The duplex printing unit is required. When the duplex printing unit is not installed, [DuplexScan] will be displayed.

Fax/I-Fax mode

Each tab can have the same set of soft keys or you can customize each tab's soft keys.

Function name	Descriptions	Fax	Internet fax	Reference page
Macro Program	Use this to perform the macro program.	✓	✓	p.10-7
Resolution*	Use this to set the scanning resolution.	✓	✓	p.3-2
Contrast*	Use this to set the scanning contrast.	✓	✓	p.3-3
Redial	Use this to specify the destination to redial.	✓		p.3-13
Monitor	Use this to obtain a dial tone for on-hook dialing.	✓		p.2-19
Address Book	Use this to specify the destination by the address book number.	✓	✓	p.2-12
Fax Forward	Makes on/off setting for fax forwarding.	✓		p.3-51
Fax & Copy	Makes on/off setting for Fax&Copy.	✓	✓	p.3-28
Program One-Touch	Use this to perform program one-touch.	✓		p.10-20
Group Tx	Use this to make a group transmission.	✓	✓	p.2-16
Security Rx	Makes on/off setting for security reception.	✓	✓	p.11-5
TTI*	Makes on/off setting for TTI sending.	✓	✓	p.3-31
TTI Select*	Select the TTI to be sent.	✓	✓	p.3-30
Cover Page*	Makes on/off setting for cover page.	✓	✓	p.3-32
Tx Report*	Makes on/off setting for print the transmit confirmation report.	✓	✓	p.13-8
Delayed Tx	Use this to make a delayed transmission.	✓	✓	p.3-34
Batch Tx	Use this to store a document for batch transmission.	✓		p.3-35
Scan Size*	Use this to specify the scanning size for documents.	✓	✓	p.3-41
Polling	Use this to make a polling reception.	✓		p.3-50
FPolling	Use this to make a F-code polling.	✓		p.10-38
F-Code Tx	Use this to make a F-code transmission.	✓		p.10-37
Overseas Tx*	Makes on/off setting for overseas transmission.	✓		p.3-43
Memory Tx*	Makes on/off setting for memory transmission.	✓		p.3-5
Dialing Options	Use this to enter a dialing character.	✓		p.3-45
Broadcast	Use this to make a broadcasting.	✓	✓	p.3-24
Mail Address	Use this when manually entering e-mail address for sending.		✓	p.4-2
Mail History	Displays the history of e-mail address manually entered using QWERTY keypad.		✓	p.4-4
Re-mail	Displays the e-mail address to which you sent last.		✓	p.4-3
e-mail Subject*	Enable to edit a subject line and a message attached to e-mail, if necessary.		✓	p.4-7
Batch Scan*	Makes on/off setting for batch scan.		✓	p.4-11
Check Mail	Use this to check new arriving e-mail immediately.		✓	p.4-12
File Format*	Use this to select the attachment format.		✓	p.4-13

(✓ : possible to setup.)

* These functions are only valid for the next transmission. Once that transmission is complete, the setting will return to its default setting. If you want to change the default setting, see "Fax settings" on page 12-4.

Scan mode

Each scan mode can have the same set of soft keys or you can customize each tab's soft keys.

Function name	Descriptions	e-mail	Folder	FTP	Reference page
Macro Program	Use this to enter, edit or perform a macro program.	✓	✓	✓	p.10-7
Doc. Type	Use this to set the document type for scanning.	✓	✓	✓	p.5-4
Contrast	Use this to set the contrast for scanning.	✓	✓	✓	p.5-3
Resolution	Use this to set the scanning resolution.	✓	✓	✓	p.5-2
Zoom	Use this to set the magnification for scanning.	✓	✓	✓	p.5-57
Scan Size	Use this to specify the scanning size for documents.	✓	✓	✓	p.5-5
Broadcast	Use this to make a broadcast.	✓	✓	✓	p.5-63
Color	Use this key to toggle the monochrome and color scan mode.	✓	✓	✓	p.5-56
Duplex Scan	Use this to scan a two-sided document.	✓	✓	✓	p.5-61
Batch Scan	Use this to select the scanned pages saved as one file or individual.	✓	✓	✓	p.5-59
File Format	Use this to select the file format for the scanned document.	✓	✓	✓	p.5-60
Mail Address	Use this when entering e-mail addresses manually.	✓			p.5-9
Attachment	Enables additional files attached to the scanned document and send.	✓	✓	✓	p.5-64
File Name	Enables to add a file name to the scanned document.	✓	✓	✓	p.5-6
Address Book	Use this to specify the destination by the address book number.	✓			p.2-12
e-mail Subject	Enables to edit a subject line and a message attached to e-mail.	✓			p.5-24
Mail History	Displays the last 20 manually entered e-mail addresses.	✓			p.5-21
Re-mail	Displays the last e-mail address you sent to.	✓			p.5-22

(✓ : possible to setup.)

Programming a soft key

- 1 Press [Setting], [Management], [Soft Key].

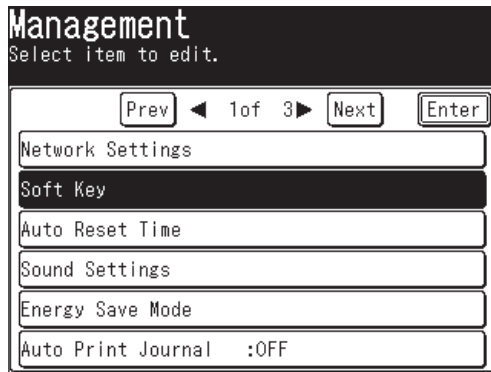

- 2 Select the standby mode.

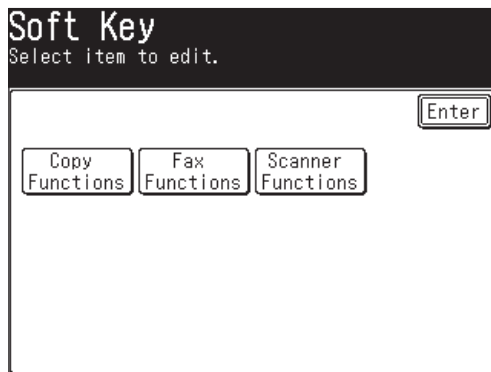

- 3 The machine shows the function currently assigned to the soft key.
Select the soft key you want to change.

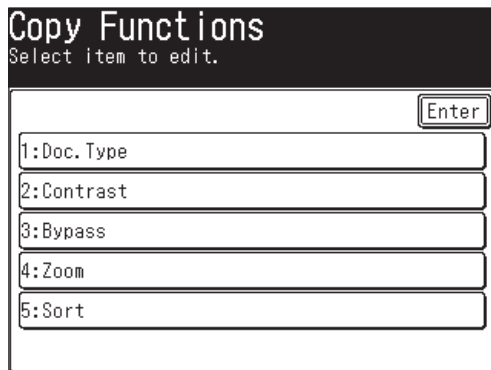

- 4 (1) Select the function you want to assign to a soft key.

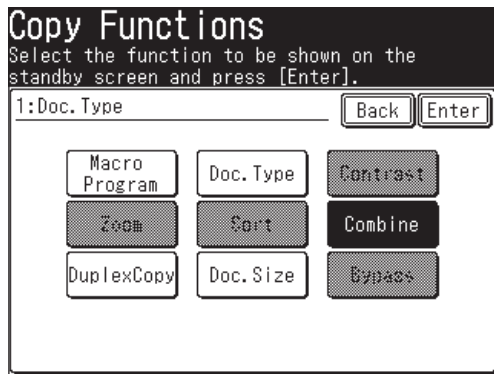

- (2) Press [Enter].

The selected function is assigned to the corresponding soft key.

- 5 If you want to program another soft key, repeat the procedures from step 3. To exit the operation, press [Reset].

NOTE: If a function is already set as a soft key, you cannot register that function into another soft key.

Macro keys

If you perform the same operation repeatedly, you can automate the operation using a macro. A macro is a series of the several steps grouped together as a single command to accomplish the operation automatically.

A macro key can record up to 60 steps.

-
- NOTE:**
- Press [Reset] first when you use other functions within a few minutes after executing Macro.
 - When you set the copy protect to [ON], you cannot use the macro program.
 - You can execute [Macro Program] from all mode of Copy, Fax and Scan by pressing [Macro Program] (See page 10-13).
 - You can assign [Macro Program] to the soft key. See “Soft keys” on page 10-2.
-

Registering or editing a Macro

- 1 In any standby mode, press [Others], [Macro Program].

NOTE: When steps have already been registered in Macros, the corresponding list of steps for that key will be displayed. In that case, press [Enter].

- 2 Press [Enter/Edit].



- 4 Select the macro key you want to register.

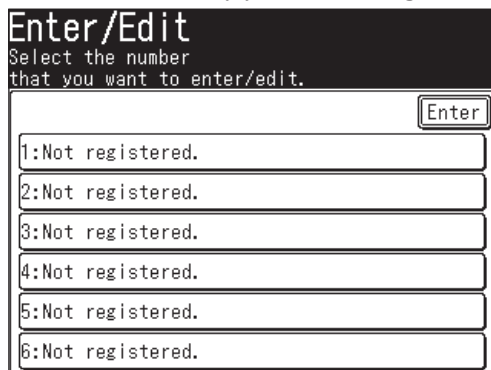

- 5 Press [Yes] to enter or edit a macro key.
- If you want to cancel, press [No] and go back to step 4.

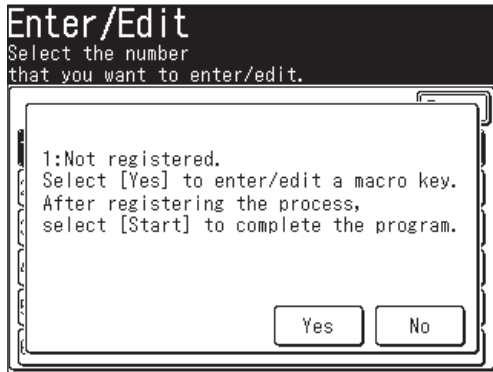

- 6 Perform the operation you want to register.

- NOTE:**
- During the programming, the machine beeps to indicate the machine is in the macro programming mode.
 - You can register up to 60 steps. When you exceed 60 steps. "Too many commands. Would you like to enter?" message will appear. If you want to register them, press [Yes]. If you want to abort, press [No].
 - While the registering, any mistakes in the operations and changes procedures are also registered.
 - Normally, the key to finish the macro registration is [Start]. However, when you select the operation including browsing the folders or files on network or searching directory as below, the key to execute the browsing operation or to execute searching directory is used to finish the registration.

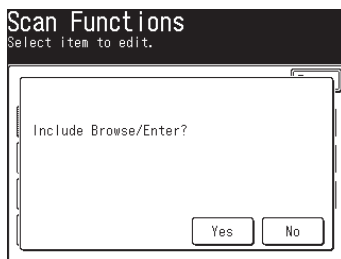

The last key in the following steps becomes the key to finish the registration.

- [SCAN], [e-mail], [Search], ([Advanced]), (Condition entry), [Execute]
- [SCAN], [e-mail], [Others], [Attachment]
- [SCAN], [Folder], [Browse]
- [SCAN], [Folder], [Add/Edit], (Number selection), [Link]
- [SCAN], [Folder], [Others], [Attachment]
- [SCAN], [FTP], [Others], [Attachment]
- [Setting], [Scanner Settings], [Folder Shortcut], [Add/Edit], (Number selection), [Link]

- 7 Press [Start] to finish the entry.

NOTE: The following display will appear when you press [Start].

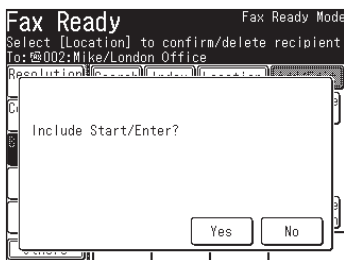

Press [Yes] to register the operation including the [Start] command.
Press [No] to register the operation but exclude the [Start] command.

You can use this function as follows:

Press [No] while registering the sending operation to exclude [Start] in the Macro command. When the Macro command is selected, all the registered steps will run but you will need to manually select [Start] to begin job execution. This allows you to perform other setting adjustments in addition to the Macro commands.

* If you press [Yes] and include [Start] in the Macro command, the fax and Internet fax will be sent. Therefore, such settings as delayed transmissions cannot be set.

- 8 Enter the title.
- The title can contain up to 60 characters.
 - For details on character entry, see page 1-10.



- 9 Press [Enter] to complete the entry.

NOTE:

- Individual operations cannot be changed once registered. You will need to return to the beginning and perform the entire entry again.
- To print a list of macro keys, press [Setting], [List], [Settings List], [Macro List], then [Yes].

Deleting a Macro key

- 1 In any standby mode, press [Others], [Macro Program], [Enter].
- 2 Press [Delete].

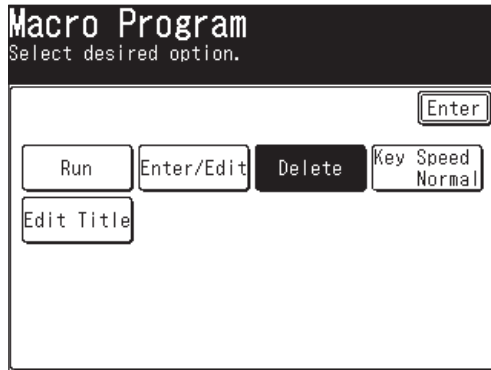

- 3 Select the macro key you want to delete.

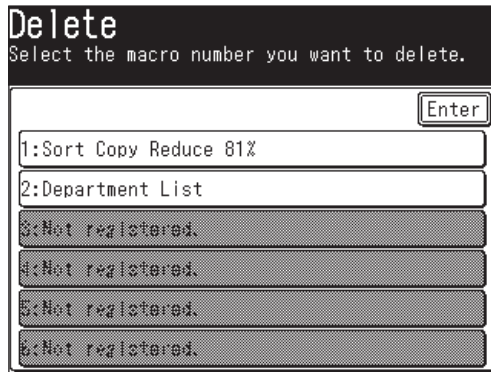

- 4 Press [Yes] to delete.
 - If you want to cancel, press [No].

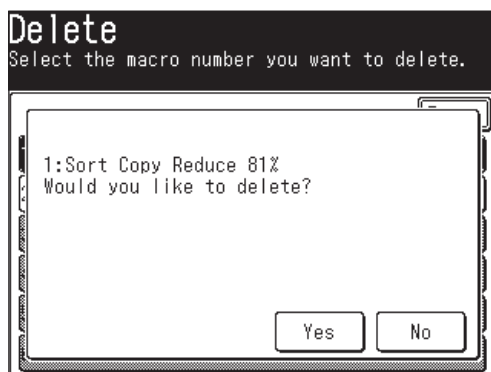

- 5 Press [Reset] to return to the standby mode.

Changing the Macro key speed

You can adjust the Macro key speed.

The default setting is “Normal”.

- 1 In any standby mode, press [Other], [Macro Program], [Enter].
If nothing is registered in “Macro No.,” you cannot change this setting.
- 2 Press [Key Speed].

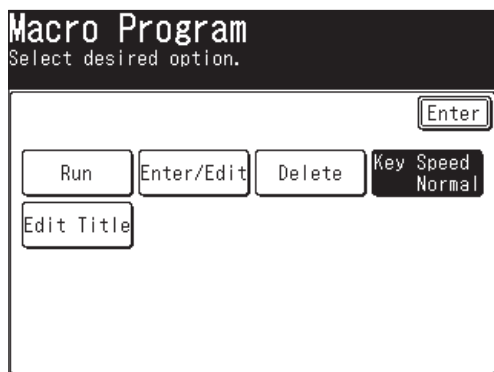

- 4 Select the key speed, and then press [Enter].

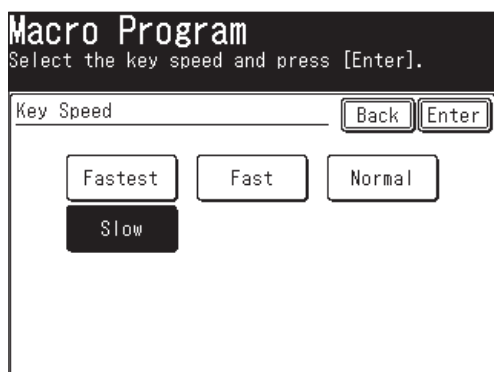

- 5 Press [Reset] to return to the standby mode.

Editing macro key titles

The Macro key titles can be edited.

- 1 In any standby mode, press [Others], [Macro Program], [Enter].
- 2 Press [Edit Title].
- 3 Select the macro key whose title you want to edit.
- 4 Edit the macro name as you want.
 - The title can contain up to 60 characters.
(For details on character entry, refer to page 1-10.)



- 5 Press [Enter] to save the title.
To edit another title, repeat from step 3.
- 6 Press [Reset] to return to the standby mode.

Executing a Macro command

- 1 In any standby mode, press [Others], [Macro Program].
- 2 Press the macro key you want to run.
If you want to stop the macro operation in progress, press [Stop].

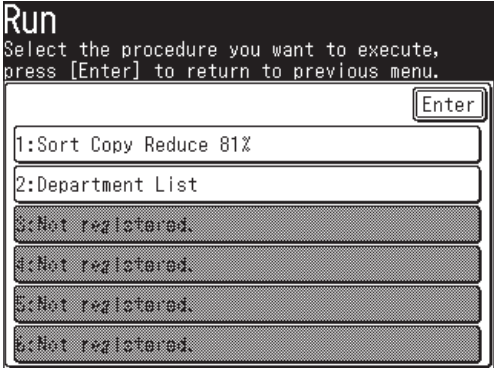

Program one-touch

By registering advanced communications in a program one-touch, you can perform a multi-step operation by simply pressing one key.

You can register the following functions:

- Delayed transmission
- Polling
- F-code polling
- F-code transmission

Delayed transmissions can be combined with any of the other three operations.

Registering or editing a program one-touch

This describes the procedure for registering a fax number or advanced communication into a programmable one-touch. You can edit the number or name by overwriting or deleting the existing information in each step.

- 1 Press [Setting], [Fax Settings], [Program One-Touch], [Enter/Edit].
- 2 Press the program one-touch number you want to register or edit.

The screenshot shows a screen titled "Enter/Edit" with the instruction "Select the number to enter/edit. Press [Enter] to continue." Below the instruction are navigation buttons: "Prev", "1 of 3", "Next", and "Enter". There are six input fields, each labeled with a number from 01 to 06 followed by a colon. All fields are currently empty.

- 3 Specify the destination. You can specify multiple destinations.
 - Press [Dialing Options], then enter the number using the numeric keys.
– or –
 - Specify the destination using the address book.
– or –
 - Press [Address Book Entry], then specify the address book number.
– or –
 - Press [Group Tx], then specify a group.

The screenshot shows a screen titled "Prog. One-Touch" with the instruction "Enter location and select [Others] to set functions. To go back, select [Back]." There are "Back" and "Enter" buttons at the top right. On the left side, there are menu options: "Address Book", "Group Tx", "Dialing Options", and "Others". In the center, there are search options: "Search", "Index", and "Location". Below these are five entries, each with a fax icon, a number, and a name: "001: Sam/New York Office", "002: Mike/London Office", "003: Carl/Paris Office", "004: Beth/Chicago Office", and "005: Chang/Beijing Office". On the right side, there are navigation buttons: "Page Up", "1 of 2", and "Page Down". At the bottom, there is a "Fax" label and a text input field.

- 4 Press [Others].
- 5 Select the advanced communication.

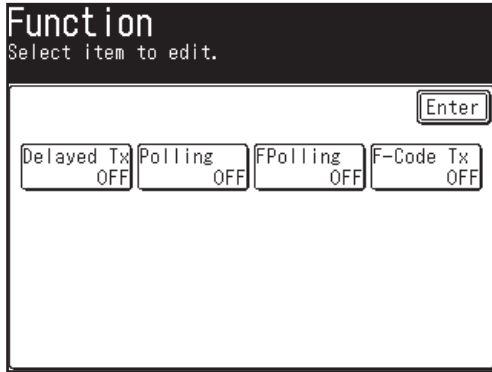

- If you press [Delayed Tx], go to step 6 of the “Delayed transmissions” on page 10-15.
- If you press [Polling], go to step 6 of the “Polling reception” on page 10-16.
- If you press [FPolling], go to step 6 of the “F-code polling” on page 10-18.
- If you press [F-Code Tx], go to step 6 of the “F-code transmission” on page 10-17.

Delayed transmissions

Delayed transmissions can be combined with any of the other three operations.

- 6 Use [▲] [▼] [◀] [▶] or the numeric keys to register the transmission time.
 - If “00” is set for the day, the communication will start on the day set for the programmable one-touch.

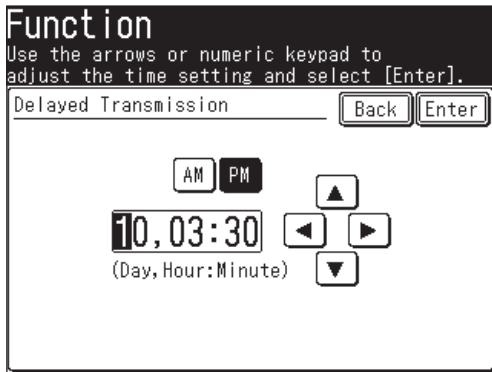

- 7 Press [Enter] to return to the display in step 5 on page 10-15.

When combining this operation with another operation, proceed to register the next operation.

- 8 When you finished the registration, press [Enter].

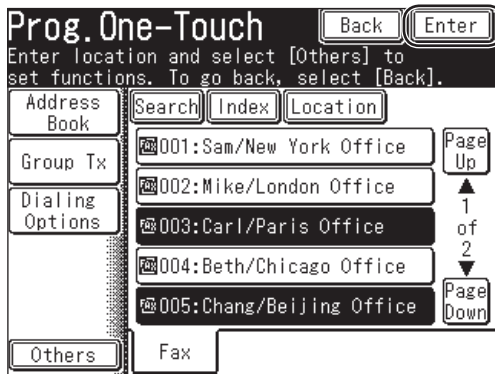

To return to the standby mode, press [Reset].

Polling reception

- 6 Press [ON].

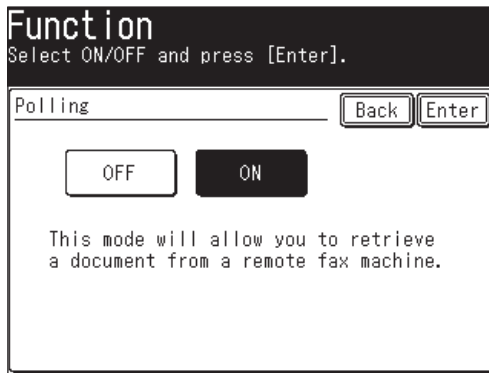

- 7 Press [Enter] to return to the display in step 5.
- If performing a delayed transmission, press [Delayed Tx] and proceed to step 6 of “Delayed transmissions”. (See page 10-15.)
- 8 Press [Enter] to complete the entry.
- 9 Press [Enter] again to finish the registration.
To return to the standby mode, press [Reset].

F-code transmission

- 6 Use the numeric keys to enter the sub-address.
 - The sub-address can contain up to 20 characters, * and/or #.

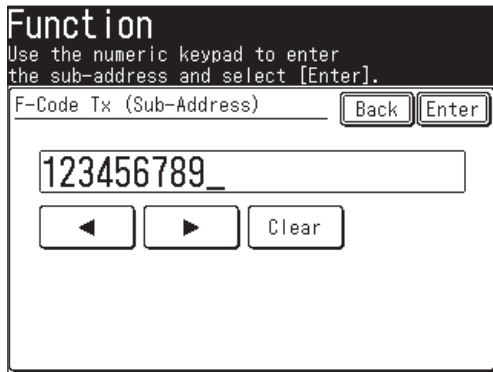

- 7 Press [Enter].
- 8 Use the numeric keys to enter the password.
 - The password can contain up to 20 characters, * and/or #.
 - If the remote machine's F-code Box has not been set a passcode, do not enter any character.



- 9 Press [Enter] to return to the display in step 4.
 - When performing a delayed transmission, press [Delayed Tx] and proceed to step 6 of "Delayed transmissions". (See page 10-15.)
- 10 Press [Enter] to complete the entry.
- 11 Press [Enter] again to finish the registration.
To return to the standby mode, press [Reset].

F-code polling

- 6** Use the numeric keys to enter the sub-address number.
 - The sub-address can contain up to 20 characters, * and/or #.

Function
Use the numeric keypad to enter
the sub-address and select [Enter].

F-Code Polling (Sub-Address) [Back] [Enter]

1234567890_

[Left Arrow] [Right Arrow] [Clear]

- 7** Press [Enter].
- 8** Use the numeric keys to enter the password.
 - The password can contain up to 20 characters, * and/or #.

Function
If a password is required enter
the password and select [Enter].

F-Code Polling (Password) [Back] [Enter]

112233_

[Left Arrow] [Right Arrow] [Clear]

- 9** Press [Enter] to return to the display in step 5.
 - When performing a delayed transmission, press [Delayed Tx] and proceed to step 6 of “Delayed transmissions”. (See page 10-15.)
- 10** Press [Enter] to complete the entry.
- 11** Press [Enter] again to finish the registration.
To return to the standby mode, press [Reset].

Deleting a program one-touch

- 1 Press [Setting], [Fax Settings], [Program One-Touch], [Delete].
- 2 Press the program one-touch number you want to delete.
- 3 When the confirmation message appears, press [Yes] to delete.
 - Press [No] to cancel the deletion.



- 4 To delete another program one-touch number, repeat from step 2. Press [Reset] to return to the standby mode.

NOTE: To print a list of program one-touch numbers, press [Setting], [List], [Other lists], [Program One-Touch], then [Yes].

How to use a program one-touch

Example: When delayed transmission has been registered.

- 1 Set the document (See page 1-25).
- 2 Press [FAX] to display the Fax standby mode.
- 3 Press [Others].
- 4 Press [Program One-Touch].

NOTE: You can assign [Program One-Touch] to the soft key. See “Soft keys” on page 10-2.

- 5 Select the program one-touch you want to execute.

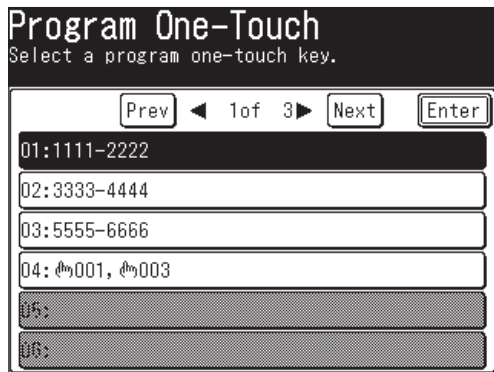

- 6 When the confirmation message appears, press [Yes] to execute it.



F-code box feature

F-code introduction

The ITU-T, the United Nations agency that standardizes international telecommunications, has created the fax industry standard for using subaddressing and password-based communication.

With subaddressing, your machine can perform secure transmissions and polling. Another term for subaddressing is F-code, which Muratec uses on the machine display and in the instruction manual.

Guidelines for using F-code

- (1) Before creating an F-code box, you must know if the remote fax machine is compatible with the ITU-T subaddressing protocol and that this feature is active on the machine.
- (2) To permit the other party to send or poll documents from your F-code boxes, you must create an F-code box in your machine and the other party must know your F-code box's subaddress and password.
- (3) To send or poll the remote fax machine's F-code boxes, you have to know their subaddress and password.

Registering or editing an F-code box

The elements of creating an F-code box are as follows:

Box Name	You can assign an identifier name for each F-code box. (The name can contain up to 16 characters.)
Sub-address	This is the ITU-T subaddress needed to perform an F-code fax transaction. (A subaddress and password can contain up to 20 characters and may consist of numbers, * or #.) The subaddress and password (if set) sent from remote fax machine must match with your F-code box's subaddress (and password) for F-code communication to be possible.
Password	This is the password for ITU-T subaddressing. Assigning a password is optional, but using a password will make your F-code communication more secure.
Box feature	You can set up an F-code box as a bulletin box or a security reception box. <ul style="list-style-type: none">• Bulletin box — Holds scanned or received documents in memory and waits for a polling request from another F-code compatible fax machine.• Security box — Documents received in the security box are held for a predetermined (by user) time period and are not printed automatically. You will need to enter an I.D. code to print them.
I.D. code	This 4-digit I.D. code protects the F-code box settings from unauthorized access. Assigning an I.D. code is optional for the bulletin box, but required for the security box.

Registering or editing an F-code box

NOTE: If you want to change an existing F-code box, you first must delete the old box before creating a new one.

- 1 Press [Setting], [Fax Settings], [F-Code Box], [Enter/Edit].
- 2 Select the F-code box you want to register.

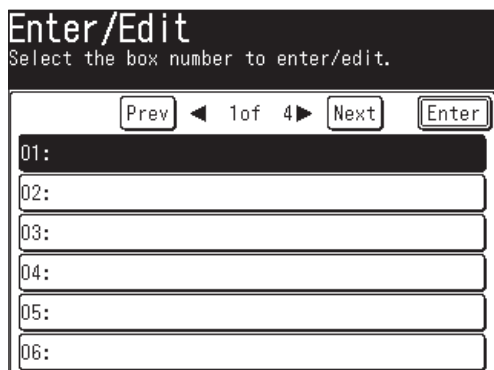

The screenshot shows a screen titled "Enter/Edit" with the instruction "Select the box number to enter/edit." Below the title is a navigation bar with buttons for "Prev", "1 of 4", "Next", and "Enter". The main area contains a list of six F-code boxes, labeled "01:" through "06:". The "01:" box is currently selected and highlighted.

- 3 Select the type of F-code box.

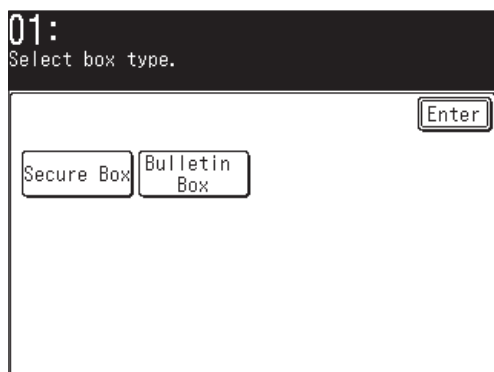

The screenshot shows a screen titled "01:" with the instruction "Select box type." Below the title is a large empty area with two buttons: "Secure Box" and "Bulletin Box". An "Enter" button is located in the top right corner.

- 4 Refer to pages 10-23 through 10-29 for the registration method.

□ If you setup a Security box

- 5 Press [Secure Box].
- 6 Use the numeric keys to enter the sub-address. This is the numerical identifier you must enter in order to communicate with any remote F-code compatible fax.
 - Up to 20 digits can be entered for sub-addresses. Numerals, #, * can be entered.
 - If the number is incorrect, press [Clear] to erase it, then re-enter the number correctly.

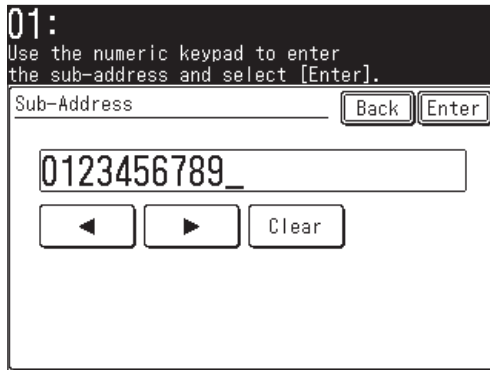

- 7 Press [Enter].
- 8 Use the numeric keys to enter the I.D. code (4 digits).
 - The I.D. code is required to retrieve documents in the security box, or to edit the box settings.
 - The I.D. code cannot be viewed after it is entered, be sure to remember this code.

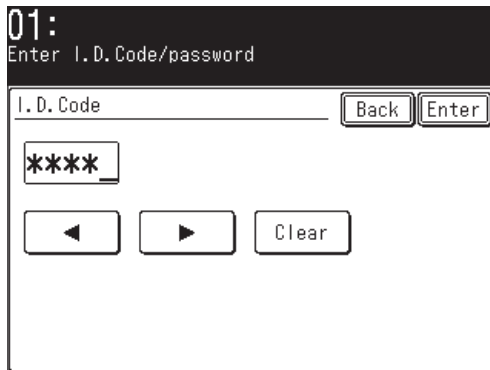

- 9 Press [Enter].

10 Enter the box name.

(1) Press [Box Name].

Secure Box
Select item to edit.

Enter

Box Name :
Sub-Address:0123456789
Password :
HoldTime :0 Day
I. D. Code :****

(2) Enter the box name.

- The name can contain up to 16 characters.
- For details on character entry, see “Entering characters” on page 1-10.

Box Name
Entry Limit 15/ 16

Back Enter

Box Name:New York Office_

1 2 3 4 5 6 7 8 9 0
q w e r t y u i o p
a s d f g h j k l @
z x c v b n m . .com
Upper Symbol Space [Cursor] Delete [Left] [Right]

(3) Press [Enter].

11 Enter the ITU-T password and hold time as necessary.

❑ Entering a password

- (1) Press [Password].
- (2) Enter the password using the numeric keys, then press [Enter].
 - Up to 20 digits can be entered for passwords. Numerals, # and * can be entered.
 - This is the password for ITU-T-compatible F-Code fax transactions. You do not need to have a password for the F-Code box. However, using a password will make your F-Code communications more secure.

The screenshot shows a screen titled "Secure Box" with the instruction "If a password is required enter the password and select [Enter]". Below this is a "Password" input field containing the text "123456789_". To the right of the input field are "Back" and "Enter" buttons. Below the input field are three buttons: a left arrow, a right arrow, and a "Clear" button.

❑ Setting the hold time

The hold time is the period (0 to 31 days) for which documents in the security box are retained. Documents are retained indefinitely when 00 days has been set.

- (1) Press [Hold time].
- (2) Enter the hold time using [▲] [▼] or the numeric keys, then press [Enter].

The screenshot shows a screen titled "Secure Box" with the instruction "Enter hold time". Below this is a "HoldTime" input field containing the text "03". To the right of the input field are "Back" and "Enter" buttons. Below the input field, the text "Input range:00-31" is displayed. Below that, the text "03 Day" is shown with up and down arrow buttons next to it. At the bottom, the text "Enter 00 to skip time setting" is displayed.

- 12** To register another F-code box, press [Enter], then repeat from step 2 of "Registering or editing an F-code box" on page 10-22. Press [Reset] to return to the standby mode.

□ If you setup a Bulletin box

- 5 Press [Bulletin Box].
- 6 Use the numeric keys to enter the sub-address. This is the numerical identifier you must enter in order to communicate with any remote F-code compatible fax.
 - Up to 20 digits can be entered for sub-addresses. Numerals, #, * can be entered.
 - If you enter an incorrect number, press [Clear] to delete it and then enter the correct one.

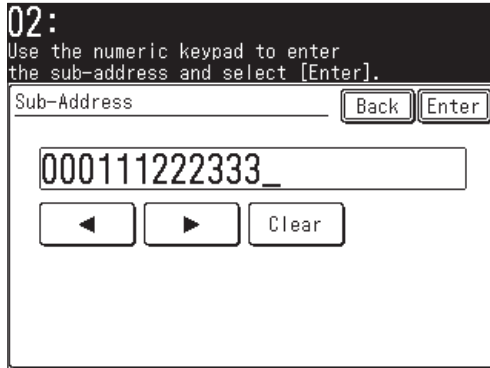

- 7 Press [Enter].
- 8 Enter the box name.
 - (1) Press [Box Name].
 - (2) Enter the box name.
 - The name can contain up to 16 characters.
 - For details on character entry, see page 1-10.



- (3) Press [Enter].
- 9 Perform settings for Password, Rx Protect, Auto Print, OverWrite, Erase Tx Doc, and I.D.Code as necessary.

❑ Entering an ITU-T password

- (1) Press [Password].
- (2) Enter the password using the numeric keys, then press [Enter].
 - Up to 20 digits can be entered for passwords. Numerals, # and * can be entered.

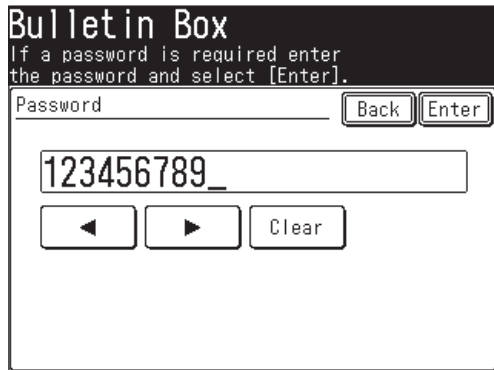

❑ Setting protected reception

- (1) Press [Rx Protect].
 - When protected reception has been set to [ON], a document cannot be received into this bulletin box.
- (2) Select either [ON] or [OFF], then press [Enter].
 - If [ON] has been selected for this setting, Auto Print and OverWrite settings are set to [OFF] and cannot be set.

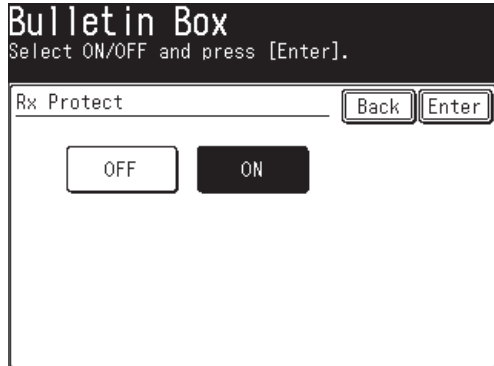

❑ Setting auto print

(1) Press [Auto Print].

- If [ON] has been selected for auto print, documents received in the bulletin box will be printed automatically when it is received.

(2) Select either [ON] or [OFF], then press [Enter].

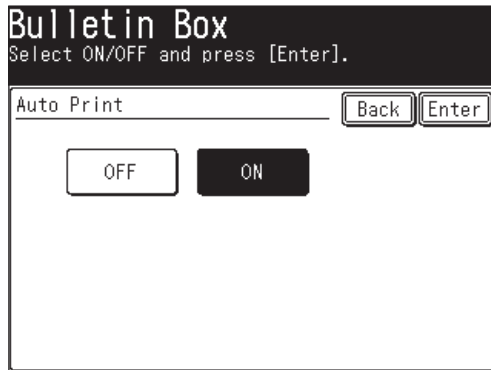

❑ Setting overwrite

(1) Press [OverWrite].

- If you set the overwrite function to [ON], newly received documents will overwrite documents previously stored in memory.

(2) Select either [ON] or [OFF], then press [Enter].

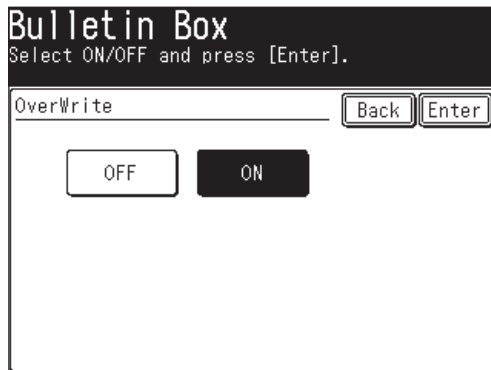

❑ Setting deletion of documents after transmission

- (1) Press [Prev] or [Next], then press [Erase Tx Doc].
 - When Erase Tx Doc has been set to [ON], the machine erases the document from the box as soon as it sends it.
- (2) Select either [ON] or [OFF], then press [Enter].

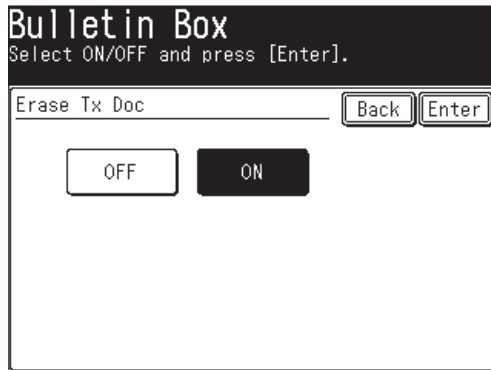

❑ Entering an I.D. code

- (1) Press [I.D.Code].
 - You do not always need to register the I.D. code. Once you register it, however, entering the I.D. code is required in the following cases.
 - When editing the box settings
 - When storing documents in the box
 - When printing the document stored in the box
 - Once entered, the I.D. code cannot be viewed. Be sure to remember this code.
 - To release the I.D. code, first enter the current registered I.D. code and then enter "0000".
- (2) Enter the I.D. code (4 digits) using the numeric keys, then press [Enter].
 - If you enter an incorrect character, press [Clear] to delete it and enter the correct character.

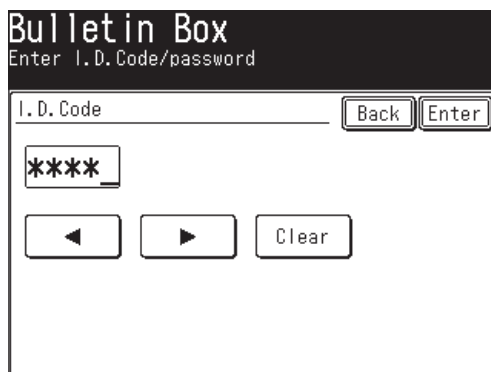

- 9** To register another F-code box, press [Enter], then repeat from step 2 of "Registering or editing an F-code box" on page 10-22. Press [Reset] to return to the standby mode.

Printing a list of F-code boxes

To print a list of your F-code boxes, press [Setting], [List], [Other Lists], [F-Code Box], then [Yes].

Printing a list of documents stored in F-code boxes

To print a list of documents stored in F-code boxes, press [Setting], [List], [Other Lists], [F-Code Doc.], then [Yes].

Deleting an empty F-code box

An F-code box must be empty in order to delete it. (If you select the F-code box which is not empty, the machine will beep. If this happens, print the documents in the box prior to deleting it.)

To delete an empty F-code box:

- 1 Press [Setting], [Fax Settings], [F-Code Box], [Delete].
- 2 Select the F-code box you want to delete.
- 3 Use the numeric keys to enter the I.D. code (4 digits) if it has been set.
If an I.D. code has not been set, proceed to step 4.
- 4 Press [Yes] to delete.
 - Press [No] to cancel the deletion.

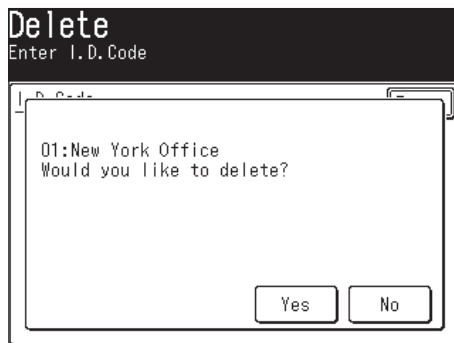

- 5 To delete another F-code box, repeat from step 2.
Press [Reset] to return to the standby mode.

Storing a document in a bulletin box

Each bulletin box can hold up to 30 documents.

- 1 Set the document (See page 1-25).
- 2 Press [Setting], [Store Doc Settings], [Store].



- 3 Press [Bulletin Box Doc.].

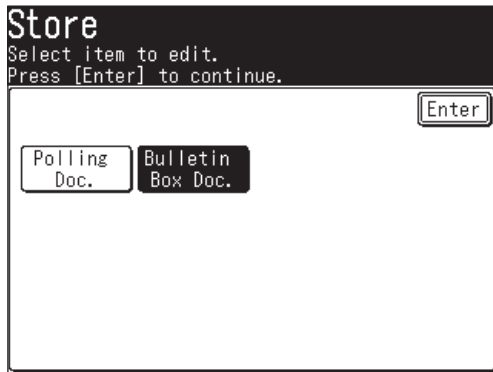

- 4 Select the F-code box that you want to store the document in.

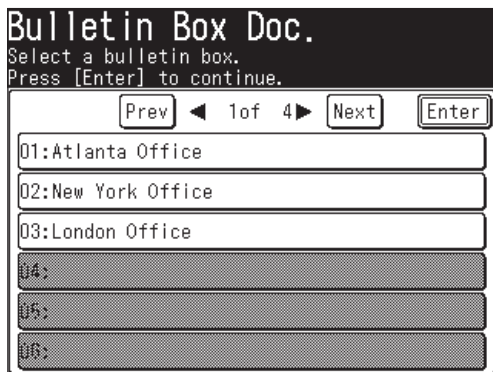

- 5 Use the numeric keys to enter the I.D. code (4 digits) if it has been set.
Proceed to step 6 if an I.D. code has not been set.

Bulletin Box Doc.
Enter I.D. Code

I.D. Code Enter

- 6 Select the document storage method.
- **Over Write**
Overwrites documents in the box.
 - **Add**
Adds documents to the box.

Bulletin Box Doc.
Select document storage method

Enter

Over-write: Replace a box document
Add : Add a box document.

- 7 Press [Yes].

Bulletin Box Doc.
Select document storage method

Over Write
Store document?

Printing stored documents

You can print out documents in the security reception box, documents received in the bulletin boxes and documents stored in the bulletin boxes.

If documents have been received into F-code boxes, the F-code reception information will be printed out. Use this information to locate and print the document.

- 1 Press [Setting], [Store Doc Settings], [Print].
- 2 Press [F-Code Doc.].

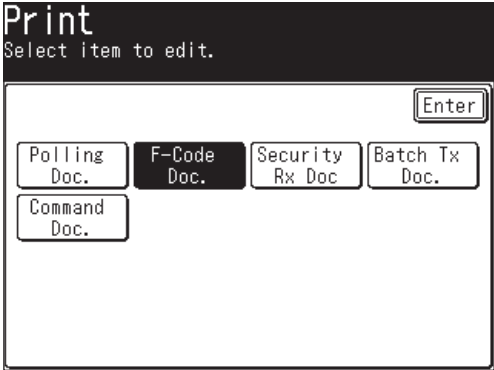

- 3 Select the F-code box that contains the document.

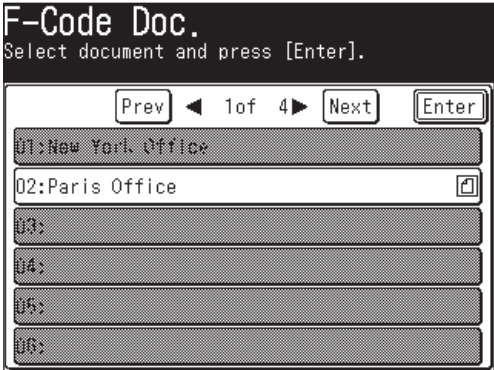

- 4 Use the numeric keys to enter the I.D. code (4 digits) if it has been set. If an I.D. code has not been set, proceed to step 5.

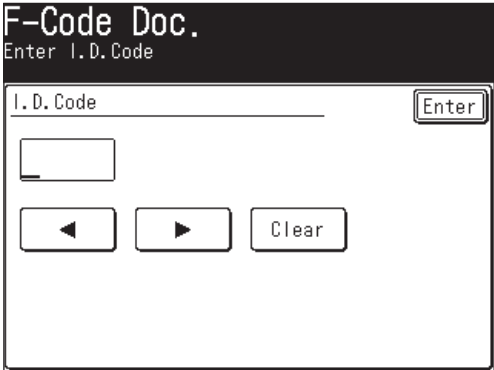

- 5** Select the applicable file number.
For security box reception, the procedure will end after step 5.
Select “All stored documents.” to print out every document stored in this F-code box.

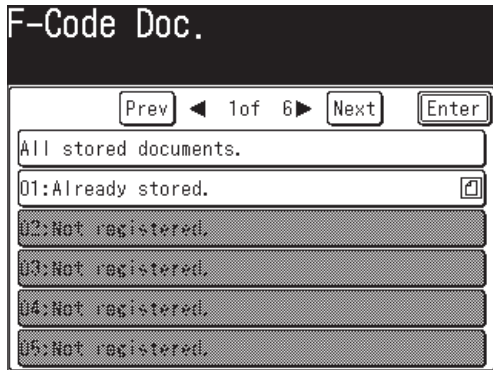

- 6** Press [Yes].
Any stored or received document will be printed.
- Documents in the security reception box will be removed from memory after they have been printed.
 - Documents received or stored in bulletin boxes will not be deleted after they are printed.

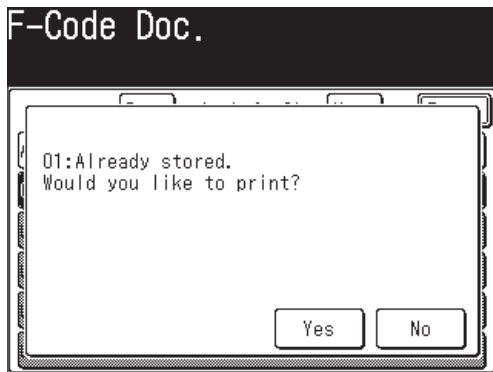

Deleting stored documents

- 1 Press [Setting], [Store Doc Settings], [Delete], [Bulletin Box Doc.].

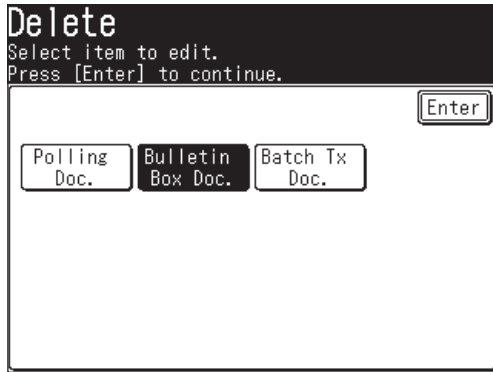

- 2 Select the F-code box that contains the document(s) you want to delete.
 - indicates that there are documents stored in the box.

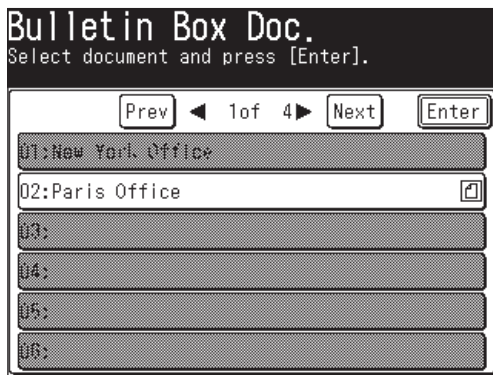

- 3 Use the numeric keys to enter the I.D. code (4 digits) if it has been set.

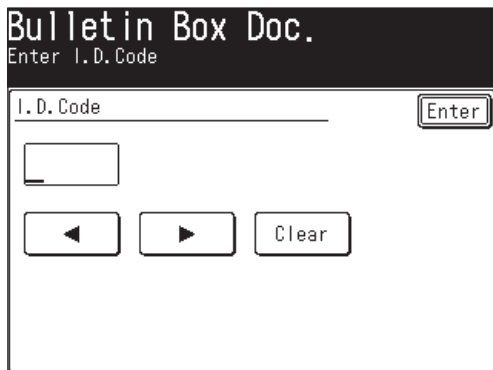

- 4 Select the applicable file number.
Select "All stored documents." to delete every document stored in this file.

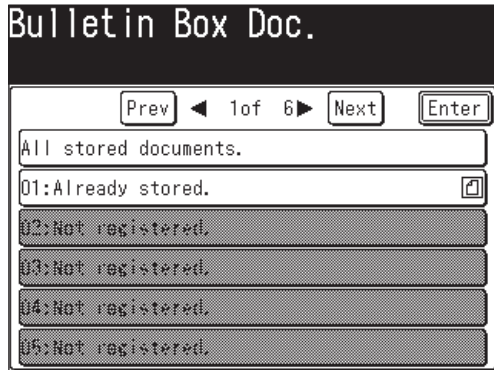

- 5 Press [Yes] to delete.

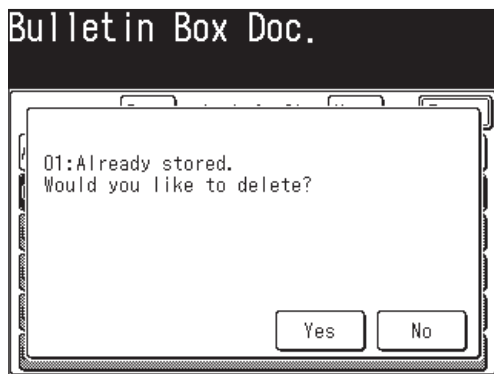

Sending a document using a subaddress and password

Entering sub-addresses and passwords enables F-code security box transmissions and F-code bulletin box transmissions to be performed.

NOTE: First check the sub-address and password for each function registered on the remote machine.

- 1 Set the document (See page 1-25).
- 2 Press [FAX] to display the Fax standby mode.
- 3 Press [Others], [Next], [F-Code Tx].

NOTE: You can assign [F-Code Tx] to the soft key. See “Soft keys” on page 10-2.

- 4 Use the numeric keys to enter the sub-address of the remote machine and then press [Enter].

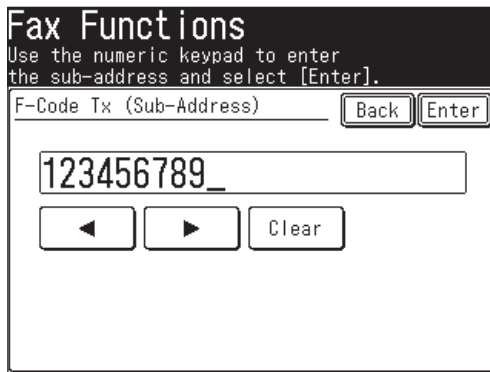

- 5 Use the numeric keys to enter the password, and then press [Enter].
 - Up to 20 digits, consisting of numerals, * and/or # can be used for passwords.
 - If a password is not required, press [Enter] without entering anything and proceed to step 6.

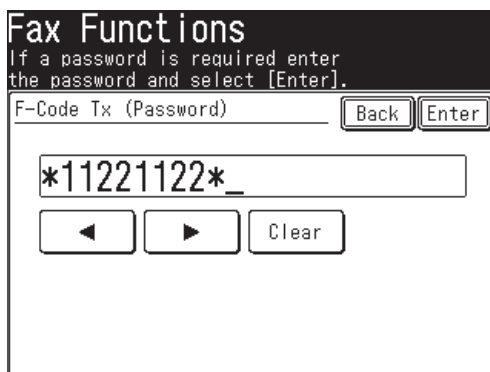

- 6 Press [Enter] to return to the standby mode.
- 7 Specify the destination and begin the fax transmission.
The numeric keys, address book and group dialing can be used.

Polling a document using a subaddress and password

Enter the sub-address and password to retrieve (polling) documents stored on a remote machine's bulletin box.

NOTE: First check the bulletin box sub-address and password on the remote machine.

- 1 Press [FAX] to display the Fax standby mode.
 - 2 Press [Others], [Next], [FPolling].
-

NOTE: You can assign [FPolling] to the soft key. See "Soft keys" on page 10-2.

- 3 Use the numeric keys to enter the sub-address of the bulletin box, then press [Enter].

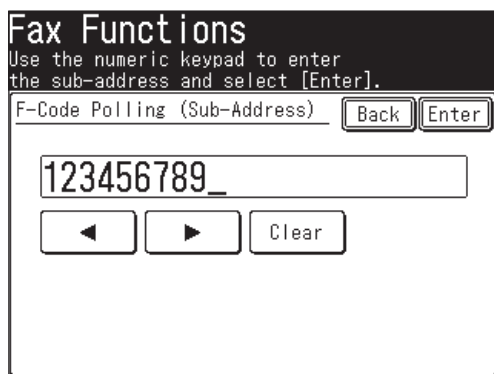

- 4 Use the numeric keys to enter the password, and then press [Enter].
 - Up to 20 digits, consisting of numerals, * and/or # can be used for passwords.
 - If a password is not required, press [Enter] without entering anything and proceed to step 5.

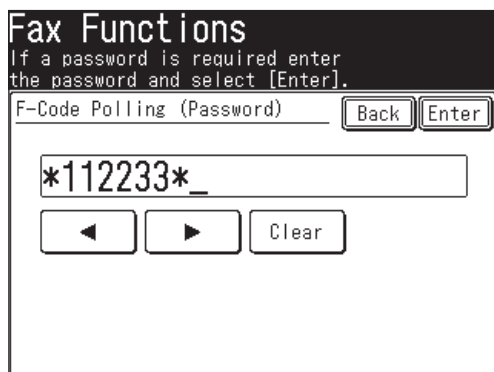

- 5 Press [Enter] to return to the standby display.
- 6 Specify the destination and begin polling.
The numeric keys, address book and group dialing can be used.

Viewing the page counters

You can check the total number of pages printed on your machine. If duplex printing is used, each side of the document will count as one print. Meaning a two-sided document counts as 2 prints.

Print Total	Shows the total number of copies, fax receptions, lists and PC printouts made.
Copy	Shows the total number of copies printed.
Fax/List	Shows the total number of fax receptions and internet fax receptions and lists printed.
PC Print	Shows the total number of printouts.

Scan Total	Shows the total number of scanned pages.
Copy	Shows the total number of copy scans.
Fax	Shows the total number of fax scans and internet fax scans.
PC Scan	Shows the total number of PC scans and scan to e-mail.

Checking the number of printed pages

You can check the total number of pages printed and scanned on your machine.

- 1 Press [Setting], [Counter].
- 2 Select [Print Total] or [Scan Total].

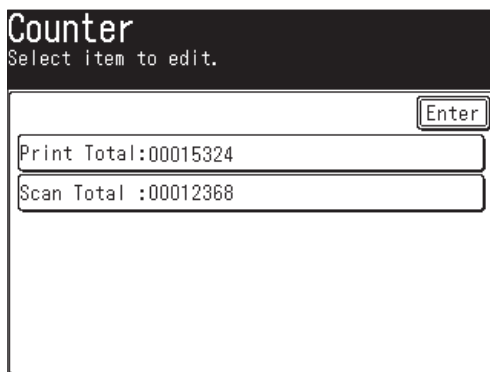

- 3 The number of pages used for each function will be displayed.

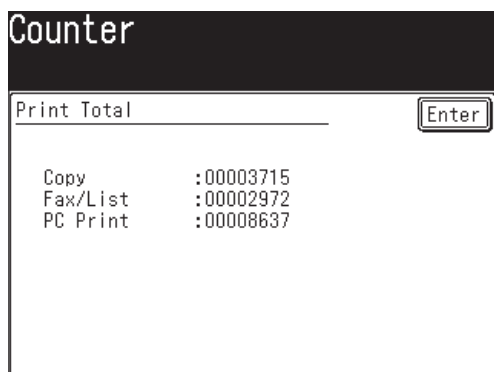

The screenshot shows a menu titled "Counter" with a dark header. Below the header, the text "Print Total" is displayed on the left, and an "Enter" button is on the right. Underneath, the following counts are listed:

Copy	:00003715
Fax/List	:00002972
PC Print	:00008637

(When [Print Total] is selected)

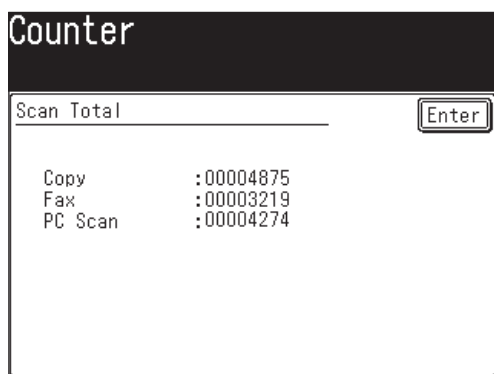

The screenshot shows a menu titled "Counter" with a dark header. Below the header, the text "Scan Total" is displayed on the left, and an "Enter" button is on the right. Underneath, the following counts are listed:

Copy	:00004875
Fax	:00003219
PC Scan	:00004274

(When [Print Total] is selected)

- 4 Press [Reset] to return to the standby mode.

Restricting use of the machine

Security features	11-2
Passcode protection.....	11-2
Security reception	11-3
PIN masking	11-7
Department management.....	11-13
Registering the copy charge (Cost management).....	11-13
Registering department codes.....	11-14
Deleting department codes.....	11-16
Turning department management On.....	11-17
Using department codes	11-17
Printing a list of department management settings.....	11-19
Resetting the department counter	11-20
Turning department management protection On/Off	11-21
Copy protection	11-22

Security features

Your machine has a number of security features to keep your fax documents private, avoid unwanted outside communication and even protect against unauthorized machine usage.

These security features include:

(1) Security reception, (2) PIN masking, (3) Block junk fax, and (4) Department codes.

Passcode protection

Your machine has a passcode protection system that secures the following features:

- Security reception
- PIN masking
- Department code protection

To set the passcode:

1 Press [Setting], [Management], [Next], [Protect Passcode].

2 (1) Enter the four-digit number.

To change or delete the protect passcode, enter the four-digit number already registered.

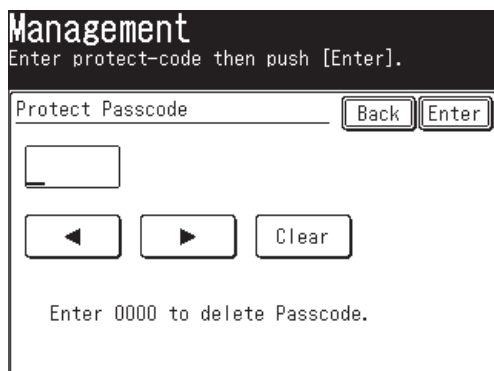

(2) Press [Enter].

The passcode has been registered.

Press [Reset] to return to the standby mode.

To change or delete the protect passcode, proceed to step 3.

3 (1) To change the protect passcode, enter a new four-digit code.

To delete the protect passcode, enter "0000".

(2) Press [Enter].

Press [Reset] to return to the standby mode.

NOTE: Write down the passcode, and put it in a safe place.

Security reception

Security reception tells your machine to keep all received faxes in memory (but not print them). You can print them out later at your convenience. This feature assists with HIPPA compliance.

NOTE: To use this feature, you must activate the passcode protection feature as described on page 11-2.

When protect passcode is [OFF], security reception will not be available.

Activating security reception

- 1 Press [Setting], [Management], [Next], [Security Reception].
 - You need to register the protect passcode in advance. (See page 11-2)

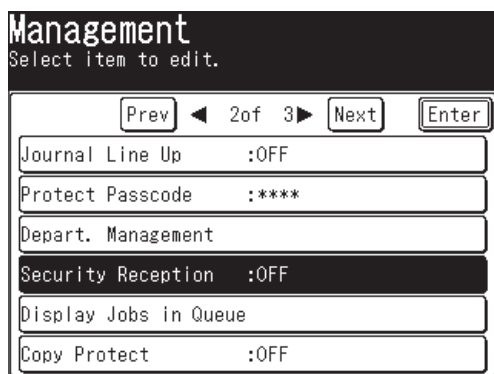

- 2 Use the numeric keys to enter the protect passcode, and then press [Enter].

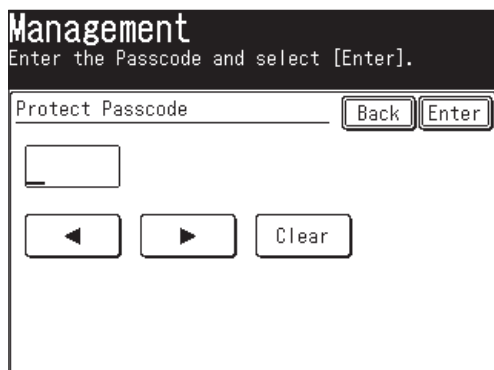

- 3** (1) Select [ON] to activate security reception and [OFF] to deactivate it.

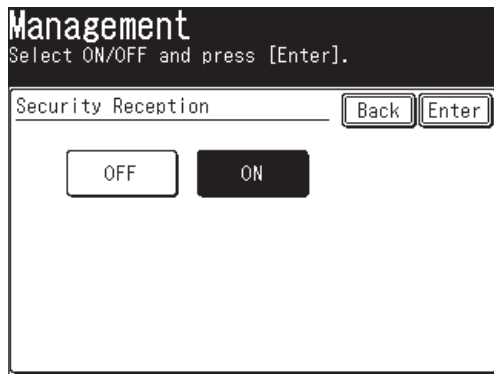

(2) Press [Enter].

- 4** If [ON] was selected in step 3, enter the start time.

(1) Use [▲] [▼] [◀] [▶] or the numeric keys to enter the security reception start time.

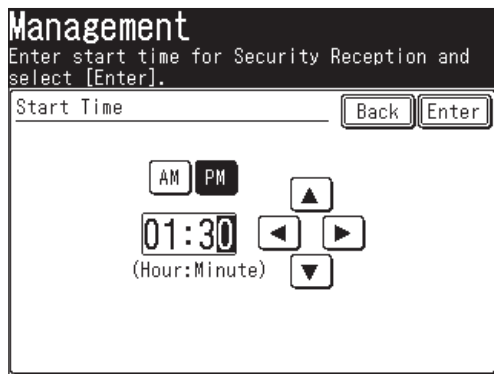

(2) Press [Enter].

- 5** Press [Reset] to return to the standby mode.

Turning on security reception in real-time

The machine will enter the security reception mode automatically at the predetermined time. If you want to put the machine into the security reception mode in real-time, you can do this using the following procedure:

NOTE: To enable the following procedure, the security reception feature must be active. (See “Activating security reception” above.)

Real-time security reception:

- 1 Press [FAX] to display the Fax standby mode.
- 2 Press [Others], [SecurityRx].

NOTE: You can assign [SecurityRx] to the soft key. See “Soft keys” on page 10-2.

- 3 (1) Use the numeric keys to enter the protect passcode.

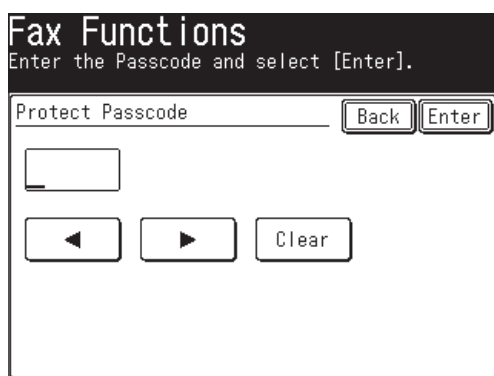

- (2) Press [Enter].

- 4 (1) Select either [ON] or [OFF].

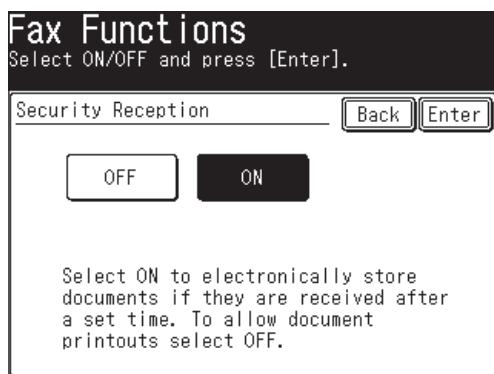

- (2) Press [Enter].

- 5 Press [Reset] to return to the standby mode.

Printing documents stored in memory

- 1 Press [Setting], [Store Doc Settings], [Print], [Security Rx Doc].
- 2 Use the numeric keys to enter the protect passcode, and then press [Enter].

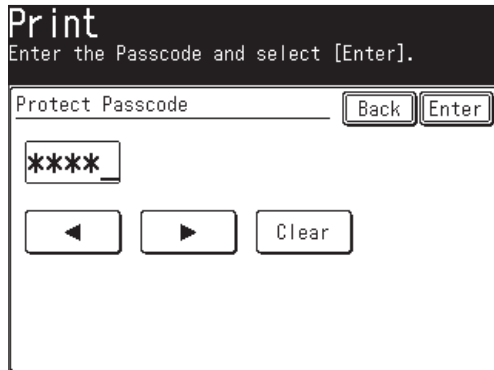

- 3 Press [Yes] to print out documents received during security reception.

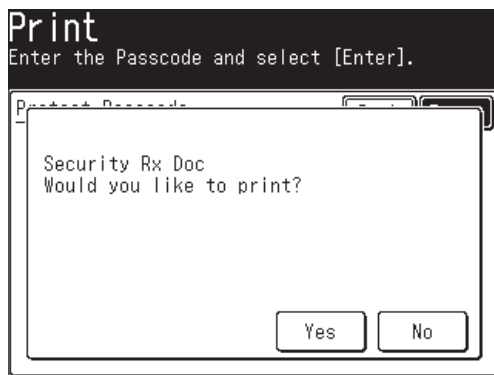

- Your machine will print all the documents received in the memory and then erase them from the memory. Then the machine turns the security reception off until the next time you have scheduled security reception.
- If the reception box is empty, "No document stored. Security Reception has been cancelled." message will appear and the display will return to the standby mode.

PIN masking

To prevent unauthorized long-distance calls, some PBX (private branch exchanger) systems require a PIN (personal identification number) entry when dialing a number.

Your machine's PIN masking feature helps you keep that PIN number private. With PIN masking activated, you can dial a number plus a PIN, but the PIN will not appear in the journal, error message printout, delayed command list or TCR (transmit confirmation report). The PIN may contain up to eight characters including the * or # symbols. You can enter them from the numeric keys.

There are three possible PIN masking settings:

- **Off** — Deactivates PIN masking. Any PIN you enter will appear on the display and/or printouts which show the number you dial.
- **Mode 1** — Each remote fax machine has a PIN access code per department.
- **Mode 2** — Each fax user has a PIN access code per department.

NOTE: If you select either Mode 1 or Mode 2 and will be using the batch transmission feature, you must store the PIN access code within the appropriate batch box.

Activating the PIN mask

NOTE: To use this feature, passcode protection must be active. (See page 11-2.)

- 1 Press [Setting], [Management], [Prev], [PIN Mode].



- 2 Use the numeric keys to enter the protect passcode, and then press [Enter].

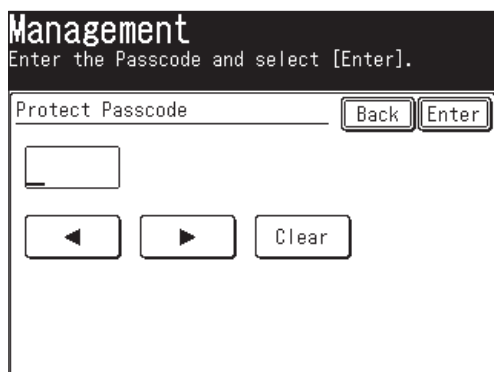

- 3 Select desired mode, and then press [Enter].
Select [OFF] to deactivate the setting.

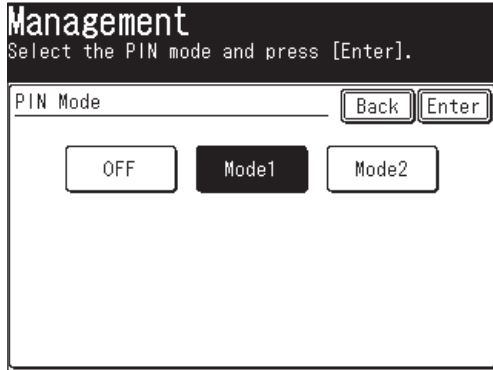

- 4 Press [Reset] to return to the standby mode.

Registering the address book (Mode 1)

In Mode 1, you must register the PIN into the address book. Transmission will not be possible if a PIN number has not been registered. If Mode 2 has been set, this procedure is not necessary.

- 1 Register or edit an entry in the address book. (See page 2-4, if necessary.)
- 2 During registration, press [PIN].

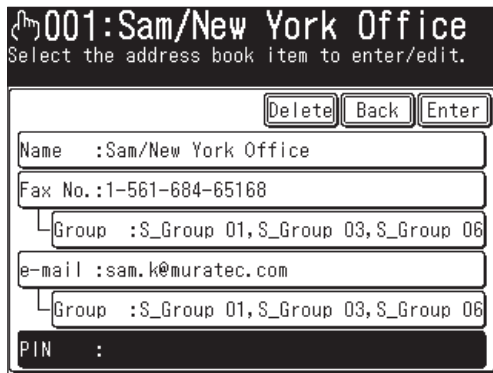

- 3 Use the numeric keys to enter the desired PIN, up to eight characters in length.

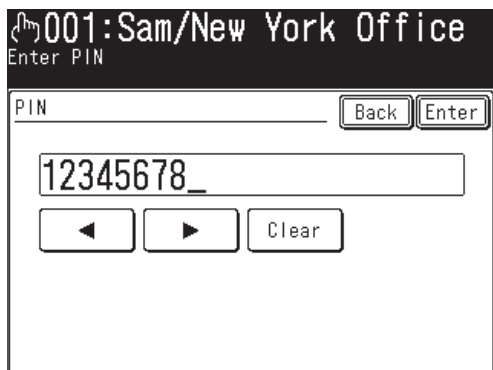

- 4 Press [Enter] to save the PIN.
- 5 Press [Enter] to save the address book setting.

- If you press [Enter] without entering the PIN, the machine will beep and display “The following data is required: PIN”, and then return to step 2.
Press [Reset] to return to the standby mode.

Registering program one-touch keys (Mode 1)

In Mode 1, you must register a PIN to the program one-touch key. Transmission will not be possible if a PIN number has not been registered. If Mode 2 has been set, the following procedure is not necessary.

- 1 Registering or editing an entry using the program one-touch keys.
(See page 10-14, if necessary.)
- 2 Enter the phone number, then press the * (“star”) to enter the PIN.
The PIN always follows the fax number.
For example, to dial 98776544 with a PIN of “12345678”, enter 98776544*12345678.

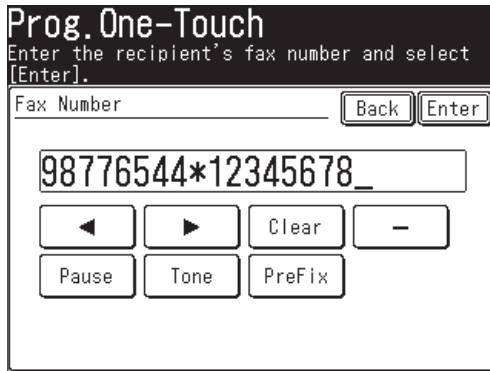

– or –

Use the address book and specify the number that contains the PIN number.
(See “Registering the address book” on page 11-8.)

NOTE: You cannot specify the destination if a PIN has not been registered. For details on registering a PIN number in the address book, see “Registering the address book (Mode 1)” on page 11-8.

- 3 Press [Enter] to save the number.
 - If you press [Enter] without entering the PIN, the machine will beep and display “The following data is required: PIN”, and then return to step 2.
Press [Reset] to return to the standby mode.
- 4 (1) Press [Others] and register the advanced communications.
(2) Press [Enter] twice to save the settings.

Dialing when using the PIN mask

□ If you select Mode 1 - use the “star” method

- 1 Set the document.
- 2 Press [FAX] to display the Fax standby mode.
- 3 Specify the destination.

If the destination was specified using the numeric keys, proceed to step 4.

If the destination was specified using the address book, the transmission will begin.

When you use the address book to specify a destination or multiple destinations, proceed to step 6.

To register an address book for transmission, the PIN needs to be registered in advance.

- 4 Enter the phone number, press * (“star”) and enter the PIN number. The PIN number always follows the fax number. For example, to dial 67778889 with a PIN of “12345678”, enter 67778889*12345678:

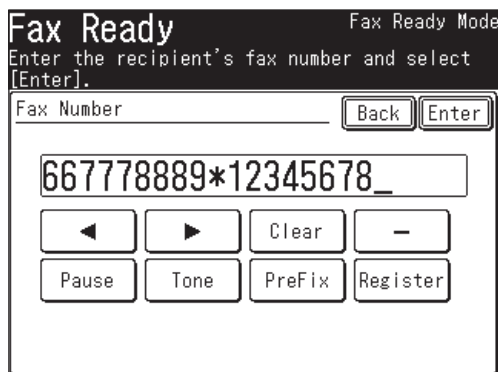

- 5 Press [Enter].
- 6 Press [Start].

□ If you select Mode 2 - the display will show the proper procedure

- 1 Set the document.
- 2 Press [FAX] to display the Fax standby mode.
- 3 Specify the destination.

If the destination was specified using the numeric keys and/or address book number, proceed to step 4.

If you specify multiple destinations, proceed to step 4.

If the destination was specified using the address book, proceed to step 5.

- 4 Press [Start].

- 5 Use the numeric keys to enter the PIN number.
Press [Reset] to cancel the settings.

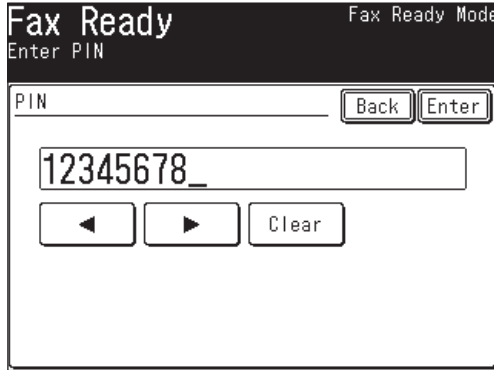

- 6 Press [Enter].

Performing a batch transmission while using the PIN mask

If you select either Mode 1 or Mode 2 and use Batch Transmission (See page 3-35), you must store the PIN access code for the remote machine within the appropriate batch box.

- 1 Follow the steps for registering or editing a batch box. (See page 3-35)
The display will ask for the fax number.
- 2 Use the numeric keys to enter the fax number for the batch transmission.

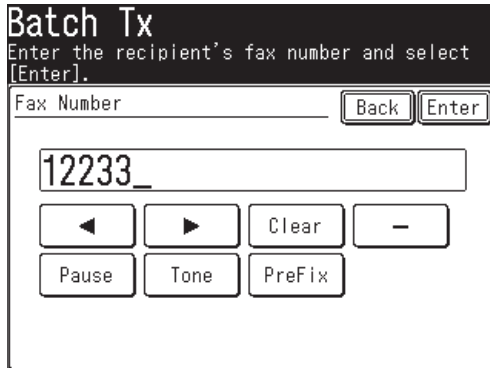

NOTE: When using Mode 2, you cannot specify the destination using the address book. Even if the number you want to register in the batch transmission has been registered in the address book, use the numeric keys to enter the destination according to the procedure.
When using Mode 1, if the destination was specified using the address book, proceed to step 4.

- 3 Enter * (“star”) and enter the PIN number.

Batch Tx
Enter the recipient's fax number and select [Enter].

Fax Number

- 4 Press [Enter] to save the setting.
Now you can perform a batch transmission with the PIN masking feature activated.
Press [Reset] to return to the standby mode.

Department management

When the department management setting is activated, the machine reminds each user to enter the department code before sending a document or making copies. With this feature, the fax transaction time and the copy charge can be managed by department.

After this setting is turned on, assign a specific code to each user/department and the machine will require them to enter their department code prior to job execution.

- (1) Registering the copy charge per page. (See below.)
↓
- (2) Registering department codes. (See page 11-14)
↓
- (3) Turning department management on. (See page 11-17)
↓
- (4) Using department codes. (See page 11-17)
↓
- (5) Checking the operating conditions. (See page 11-19)

Registering the copy charge (Cost management)

Register a cost per page for copying.

- 1 Press [Setting], [Management], [Next], [Depart. Management].

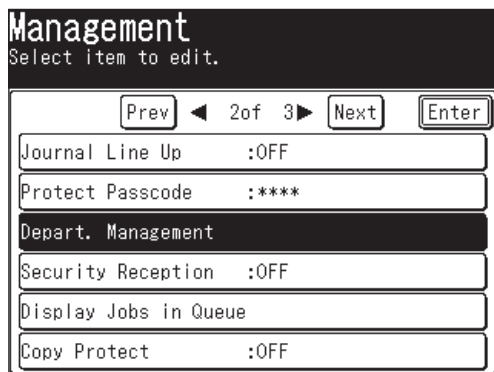

- 2 Press [Cost] to register the copy charge.

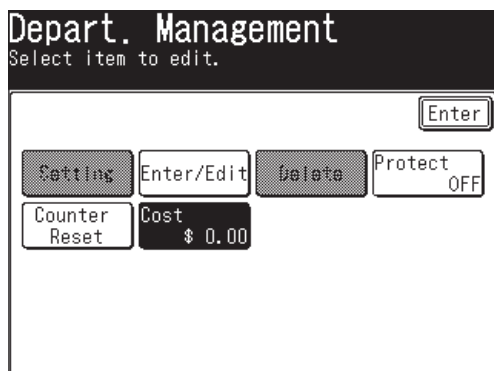

- 3 Use [▲] [▼] or the numeric keys to enter the cost per page.

Depart. Management
Enter the per sheet copy charge and select [Enter].

Cost Management Back Enter

Input range: 0.00-99.99

\$00.05 /Page ▲
▼

- 4 Press [Enter].
- 5 Press [Reset] to return to the standby mode.

Registering department codes

You can register up to 100 department codes.

- 1 Press [Setting], [Management], [Next], [Depart. Management], [Enter/Edit].
- 2 Select the department code you want to register.
 - Press [001:] for the first entry.
 - To edit the name and number of a department already registered, select the number you want to edit.

Enter/Edit
Select a number to enter/edit.

Enter

001:

- 3 Enter the department code using [▲] [▼] or the numeric keys and then press [Enter].

Up to 9 digits can be entered.

Enter/Edit
Enter the department code
and select [Enter].

Department Code Back Enter

Input range: 000000000-999999999

- 4 Press [Department Name] to register the department name.

001:000000110
Select item to edit.

Department Code: 000000110 Enter

Department Name:

- 5 Enter the department name, and then press [Enter].
 - The department name can contain up to 20 characters. (For details on character entry, see page 1-10.)

Department Name
Enter the department name and select [Enter].
Entry Limit 14/20

Department Name: Domestic Sales_ Back Enter

1 2 3 4 5 6 7 8 9 0
q w e r t y u i o p
a s d f g h j k l @
_ z x c v b n m . .com
Upper Symbol Space ← Delete →

- 6 The list will be displayed and all registered data will appear.
- 7 To register another department code, press [Enter] and repeat the procedures from step 2.
Press [Reset] to return to the standby mode.

Deleting department codes

- 1 Press [Setting], [Management], [Next], [Depart. Management], [Delete].
- 2 Select the department code you want to delete.

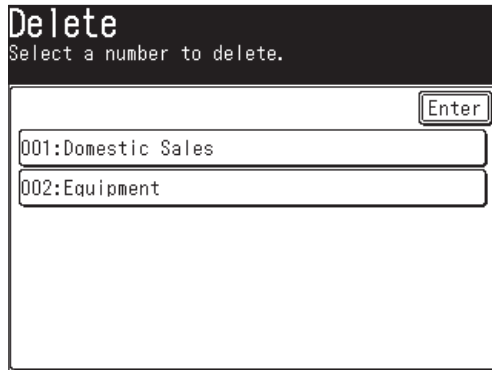

- 3 Press [Yes] to delete.
Press [No] to return to step 2 without deleting the number.



- 4 To delete another department code, repeat the procedures from step 2.
Press [Reset] to return to the standby mode.

Turning department management On

- 1 Press [Setting], [Management], [Next], [Depart. Management], [Setting].
- 2 Press [Copy] to set the department management status for copying, and/or press [Fax] for faxing.
[ON] and [OFF] will toggle each time you press the key. To use department management, set it to [ON].

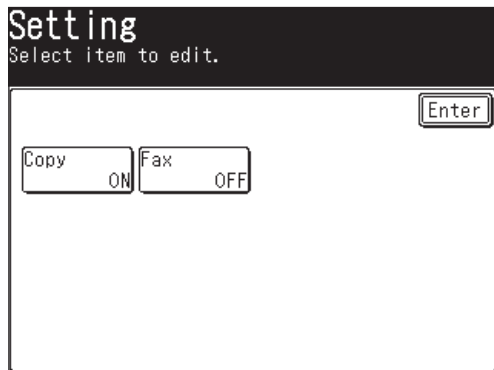

Using department codes

To use this function, make sure:

- The department code has been registered.
- Each user/department knows their department code.

Transmitting faxes

- 1 Set the document (See page 1-25).
- 2 Press [Fax] to display the Fax standby mode.
- 3 Specify the destination.
- 4 Press [Start].
- 5 Use [▲] [▼] or the numeric keys to enter the department code.

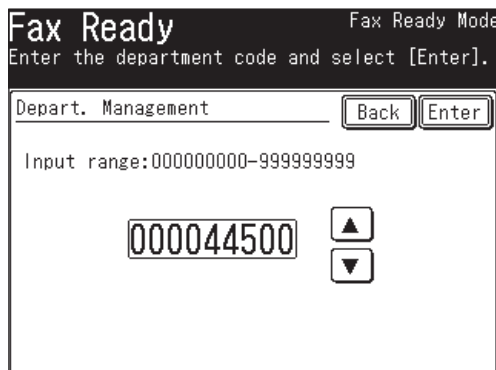

- 6 Press [Enter].
Press [Reset] to reset the sending settings.

Making Copies

- 1** Set the document (See page 1-25).
- 2** Press [COPY] to display the Copy standby mode.
- 3** Use [▲] [▼] or the numeric keys to enter the department code.
If you press [Back], the department code entry display will disappear. Press [Start] to display it again.

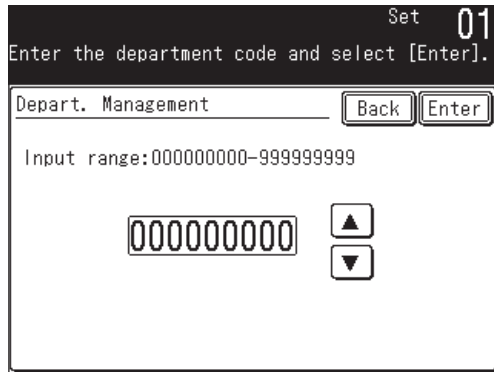

- 4** Press [Enter].
- 5** Press [Start].
If you continue to make copies, you do not need to enter the department code. If you select [Reset] and return to the standby mode, you will be asked to enter the department code again. If the machine is shared by multiple departments, select [Reset] after you have completed your job.

Printing a list of department management settings

The department management list includes the following information for each department:

- Copy charge (\$/page)
- Department code
- Department name
- Total communication time (in hours, minutes and seconds; h:mm:ss)
Counts the communication time up to 999:59:59 (999 hours:59 minutes:59 seconds). If the fax exceeds the maximum time, it will stop counting.
- Total fax pages printed
Counts the pages up to 999999 pages. If the fax count exceeds the maximum limit, it will stop counting.
- Total pages copied
Counts the pages up to 999999 pages. If the copy count exceeds the maximum limit, it will stop counting.
- Total copy charge
Counts the copy charge up to 99.99. If the copy charge exceeds the maximum charge, it will stop counting.

NOTE: If you want to reset the counter, see “Resetting the department counter” on the next page.

To print the list:

Press [Setting], [List], [Settings List], [Department List], then [Yes]. The department list will be printed.

NOTE: If the department management feature has been protected (See page 11-21), you cannot print the department list. You will have to deactivate the password protection feature in order to print.

Resetting the department counter

To delete the current counts for department management

- 1 Press [Setting], [Management], [Next], [Depart. Management].
- 2 Press [Counter Reset].

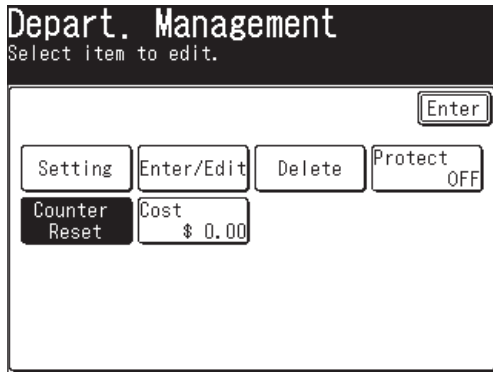

- 3 Press [Yes] to reset the counter for each department.
Press [No] to return to step 2.

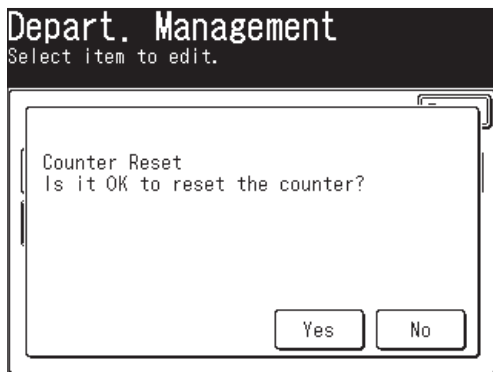

- 4 Press [Reset] to return to the standby mode.

Turning department management protection On/Off

This feature protects the department management settings from unauthorized access. After you set it, you will have to enter the passcode to access the department management settings.

NOTE: This feature will work only if you have activated the passcode protection (See page 11-2.)

- 1 Press [Setting], [Management], [Next], [Depart. Management], [Protect].
- 2 Use the numeric keys to enter the passcode, and then press [Enter].

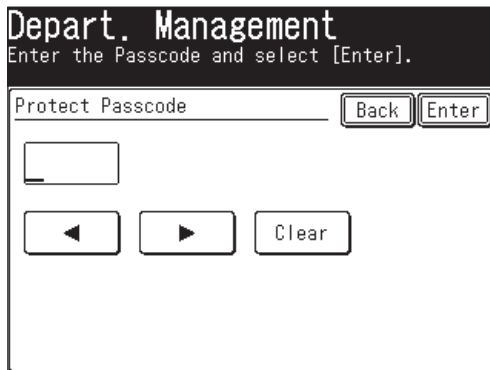

- 3 Press [ON] to protect department management.
 - Press [OFF] to cancel the function.

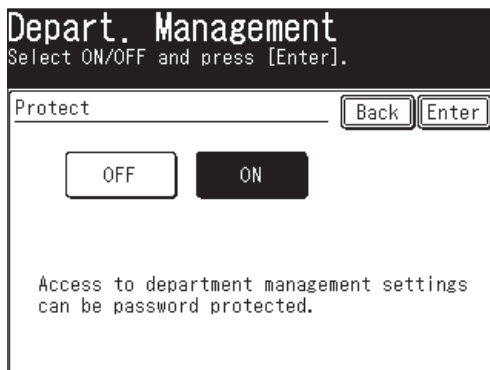

- 4 Press [Enter] to save the setting.
- 5 Press [Reset] to return to the standby mode.

Copy protection

Limit the use of your machine to send/receive only, meaning the copy mode cannot be used:

- 1 Press [Setting], [Management], [Next], [Copy Protect].

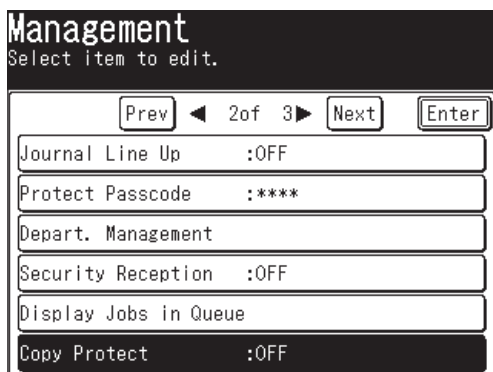

- 2 When the protect passcode is set, use the numeric keys to enter the protect passcode and press [Enter].

When it has not been set, proceed to step 3.

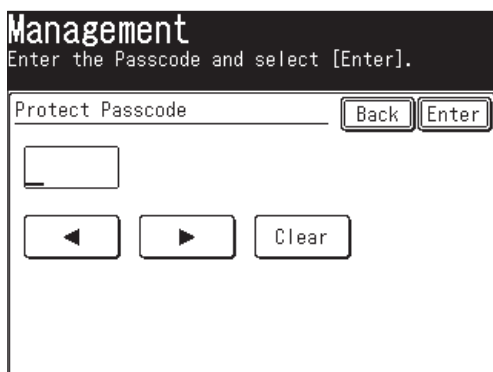

- 3 Press [ON] to activate copy protection.

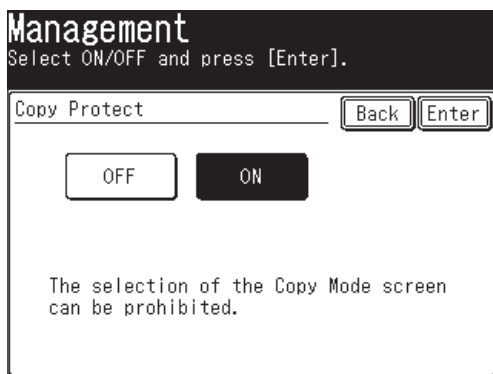

4 Press [Enter] to save the setting.

If copy protection is active, whenever someone tries to switch the machine to the copy mode, the machine will beep and display “Copy protected”.

NOTE: When you set the copy protect to [ON], you cannot use the macro program.

Chapter

12

Machine Settings

Machine setting menu	12-2
Copy settings	12-3
Accessing the copy settings	12-3
Fax settings	12-4
Accessing the default fax settings.....	12-4
Accessing other fax settings.....	12-5
Scanner settings.....	12-7
Accessing the default scan settings	12-7
Accessing other scan settings.....	12-8
Mail settings.....	12-9
Accessing the mail settings	12-9
Management settings	12-11
Accessing the management settings.....	12-11
Paper settings.....	12-14
Accessing the paper settings	12-14

Machine setting menu

By pressing [Setting] on the control panel, you can see the machine setting menu.

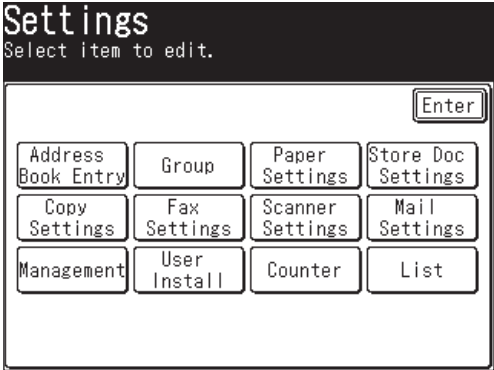

Copy settings

The copy settings allow you to customize various copy settings to match your needs.

Accessing the copy settings

- 1 Press [Setting], [Copy Settings].

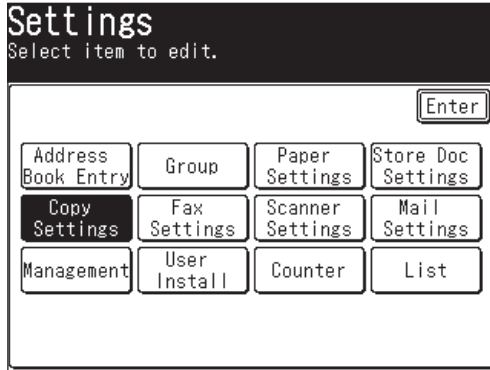

- 2 Set or change the selected items.

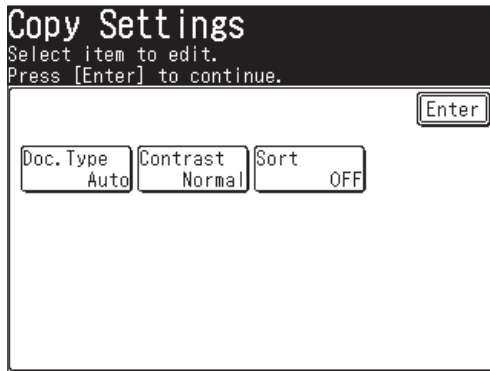

For details on each setting, refer to the following table:

- 3 When you are finished, press [Reset] to return to the standby mode.

The underlined settings are factory defaults.

Function	Description	Setting
Doc. Type	This sets the default setting for the resolution of the document to be copied. Matching the settings to the frequently copied documents can shorten the time required to adjust settings.	Text, <u>Auto</u> , Photo, Text High-Res, Text&Photo High-Res, Photo High-Res
Contrast	This sets the default setting for the contrast of the document to be copied. Matching the settings to the frequently copied documents can shorten the time required to adjust settings.	Lightest, Lighter, Normal, <u>Darker</u> , Darkest
Sort	Sort will be defaulted to "Sort". [ON] and [OFF] toggle every time you press [Sort].	ON, <u>OFF</u>

Fax settings

You can customize the fax settings to match your needs.

This section describes [Default Settings] and [Other Settings].

For details on other items, see below.

- Program One-Touch (See page 10-14.)
- Fax Forward (See page 3-51.)
- Cover Page (See page 3-32.)
- Batch Tx Box (See page 3-35.)
- F-Code Box (See page 10-21.)

Accessing the default fax settings

1 Press [Setting], [Fax Settings].

2 Press [Default Settings].

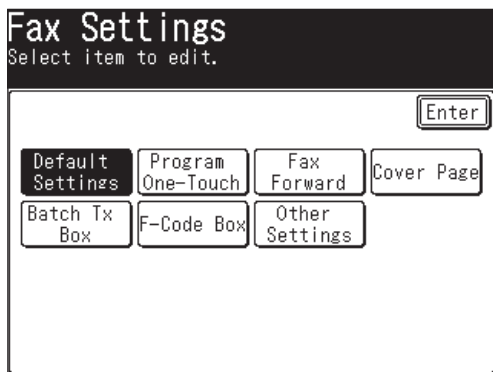

3 Set or change the selected items.

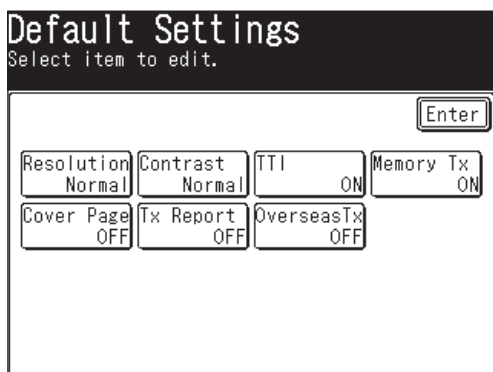

For details on each setting, refer to the following table:

4 When you are finished, press [Reset] to return to the standby mode.

The underlined settings are factory defaults.

Function	Description	Setting
Resolution	This sets the default setting for the resolution of the document to be scanned. By setting it to a level suitable for the most commonly sent document type, you can reduce the time and effort required when making changes.	<u>Normal</u> Fine S-Fine Photo
Contrast	This sets the default setting for the contrast of the document to be scanned. By setting it to a level suitable for the most commonly sent document type, you can reduce the time and effort required when making changes.	Lightest <u>Lighter</u> <u>Normal</u> Darker Darkest
TTI	Set to [ON] to send the TTI information. [ON] and [OFF] toggle every time you press [TTI].	<u>ON</u> OFF
Memory Tx (See page 3-5)	This sets whether to give the priority to memory transmission or to real-time transmissions when sending faxes. Memory transmissions are prioritized when [ON] is set and real-time transmissions when [OFF] is set. You can also select to give the priority to memory transmissions or to real-time transmissions each time you send a fax. [ON] and [OFF] toggle every time you press [Memory Tx].	<u>ON</u> OFF
Cover Page (See page 3-32.)	Set to [ON] to add a cover page containing a simple message to every fax. [ON] and [OFF] toggle every time you press [Cover Page].	ON <u>OFF</u>
Tx Report (See page 13-8.)	Set to [ON] to print out a transmission report for each fax. [ON] and [OFF] toggle every time you press [Tx Report].	ON <u>OFF</u>
Overseas Tx	Set to [ON] to enable the overseas transmission all the time. [ON] and [OFF] toggle every time you press [OverseasTx].	ON <u>OFF</u>

Accessing other fax settings

- 1 Press [Setting], [Fax Settings].
- 2 Press [Other Settings].
- 3 Set or change the selected items.

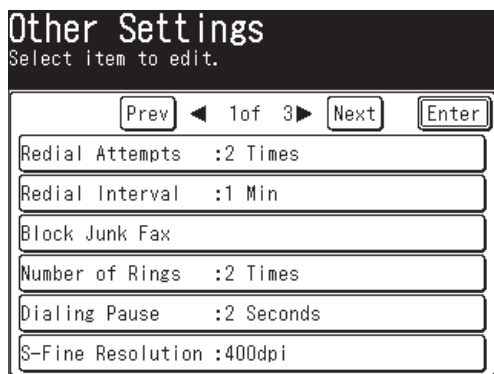

For details on each setting, refer to the following table:

- 4 When you finish, press [Reset] to return to the standby mode.

The underlined settings are the factory defaults.

Function	Description	Setting
Redial Attempts	This sets the number of times for redial attempts when the destination line is busy. The interval between redial attempts is set at "Redial Interval".	2–15 times: <u>2 times</u>
Redial Interval	This sets the interval between redial attempts.	1–5 minutes: <u>1 minute</u>
Block Junk Fax (See page 3-46.)	This function enables you to block receipt of unnecessary faxes.	
Number of Rings	This sets the number of times the machine will ring before fax reception when the reception mode is set to Fax or Tel/Fax.	1–10 times: <u>2 times</u>
Dialing Pause	This sets the default for the dialing interval (2-10 seconds) when the pause symbol is input.	2–10 seconds: <u>2 seconds</u>
Super-Fine Resolution	This sets the dpi for resolution when a document is scanned for S-Fine transmission. If 600 dpi is set, the scan is sharper than with 400 dpi; however, it may result in memory overflow when the document is sent.	600dpi <u>400dpi</u>
Rx Reduction Rate (See page 3-20.)	Select from [Auto], which automatically selects the magnification according to the length of the received document, or [100%] to have all faxes printed out at the same rate of reduction.	<u>Auto</u> 100%
Reduction Margin (See page 3-20.)	This sets at what point the document printout will extend to the following page if the received document cannot fit within the effective recordable area.	0.0–3.3 inches: <u>1.5 inches</u>
Paper Saving (See page 3-21.)	This sets the print method for the received documents. If it is set to "H-Page Rx" and 2 pages of Half-Letter is received in succession, the two pages will be reduced at the appropriate rate and printed out on one sheet of paper. If it is set to "Duplex Rx*", both sides of each sheet of paper will be used for printouts. *A duplex printing unit is required for duplex reception.	<u>OFF</u> H-Page Rx Duplex Rx*
Quick Memory Tx	If this is set to [ON], fax transmission for multiple documents will begin in the page order when it has been scanned and stored.	<u>ON</u> OFF
ECM Mode	Any part of a fax that was not send correctly due to the line error will automatically be resent. (The destination must have the same function for it to work.)	<u>ON</u> OFF
Service Mode	Do not set.	–
Dial PreFix (See page 3-44.)	The connection number as Dial PreFix No. can be registered to allow easy access to other phone networks.	
Receive Time Stamp	If this is set to [ON], the received date (year, month, day) and time can be printed with the word "Received" at the header of the received document. <div style="text-align: center;"> <p>Received Time your machine prints.</p> <p>Sender name Received Fax: Sender fax number MAY 5 2005 02:16pm MAY 5 2005 02:15pm P.01/01</p> </div> <div style="text-align: center;"> <p>THE SLEREXE COMPANY LIMITED</p> <p>SAPORS LANE - BOOLE - DORSET - BH25 8ER</p> <p>TELEPHONE BOOLE (94513) 51617 - TELEX 123456</p> <p>Sender information sent from the remote fax.</p> </div> <p>NOTE: If the receiving reduction rate is fixed to 100% and the reduction margin setting is small, the received document could be divided into 2 sheets by attaching the Receive Time Stamp.</p>	<u>OFF</u> ON

Scanner settings

You can customize the scanner functions to match your needs.

Accessing the default scan settings

- 1 Press [Setting], [Scanner Settings].
- 2 Press [Default Settings].

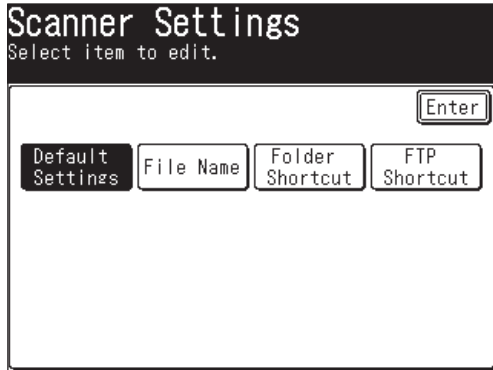

- 3 Set or change the selected items.

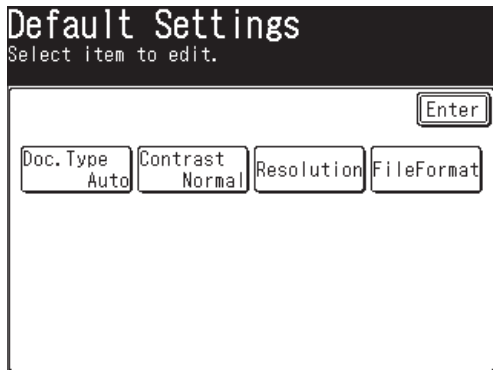

For details on each setting, refer to the following table:

- 4 When you are finished, press [Reset] to return to the standby mode.

The underlined settings are factory defaults.

Function	Description	Setting
Doc. Type	This sets the default setting for the resolution of the document to be scanned. Matching the settings to the frequently scanned documents can shorten the time required to adjust settings.	Text, <u>Auto</u> , Photo
Contrast	This sets the default setting for the contrast of the document to be scanned. Matching the settings to the frequently scanned documents can shorten the time required to adjust settings.	Lightest, Lighter, Normal, <u>Darker</u> , Darkest
Resolution	This sets the resolution when scanning the document. You can set the different settings for monochrome documents and color documents.	<ul style="list-style-type: none"> • Monochrome 200dpi, 300dpi, 600dpi • Color <u>100dpi</u>, 200dpi, 300dpi, 600dpi
File Format	Select the default file format for scanning. You can set the different file format for monochrome documents and color documents respectively.	<ul style="list-style-type: none"> • Monochrome <u>TIFF</u>, PDF • Color JPEG, PDF

Accessing other scan settings

- 1 Press [Setting], [Scanner Settings].
- 2 Set or change the selected items.

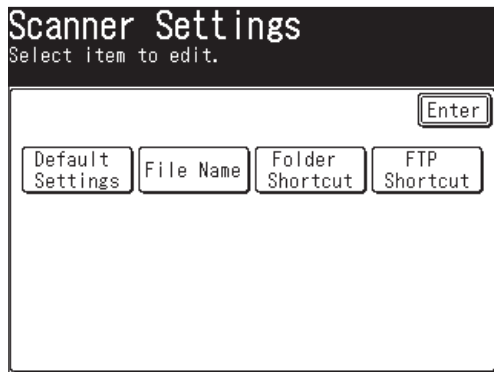

For details on each setting, refer to the following table:

- 3 When you are finished, press [Reset] to return to the standby mode.

The underlined settings are the factory defaults.

Function	Description	Setting
File Name	You can register a file name in advance for scanned file. If you register a file name, you can choose it instead of entering a file name when scanning a document.	For details of registering a file name, see page 5-8.
Folder Shortcut	You can create a shortcut of Windows shared folder on your machine. You can also edit or delete the created shortcuts.	For details of registering a folder shortcut, see page 5-35.
FTP Shortcut	You can create a shortcut of FTP server on your machine. You can also edit or delete the created shortcuts.	For details of registering FTP shortcut, see page 5-49.

Mail settings

You can customize the mail settings to match your needs.

Accessing the mail settings

- 1 Press [Setting], [Mail Settings].
- 2 Press [I-Fax] or [e-mail] for the individual settings of internet fax and e-mail.
Set or change the selected items.

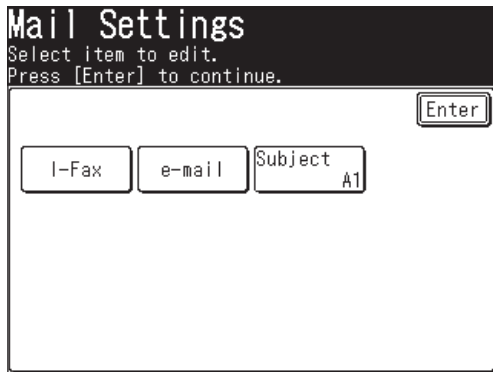

For details on each setting, refer to the following table:

- 3 When you are finished, press [Reset] to return to the standby mode.

❑ When you press [I-Fax]

The underlined settings are the factory defaults.

Function	Description	Setting
File Format	Select the default file format for scanning.	<u>TIFF-S</u> , <u>TIFF-F</u> , PDF
Batch Scan	When you set it to [OFF], you can divide the scanned documents into page unit to send it as a separate e-mail respectively.	<u>ON</u> , OFF See page 4-11.

❑ When you press [e-mail]

The underlined settings are the factory defaults.

Function	Description	Setting
File Format	Select the default file format for scanning. You can set the different file format for monochrome documents and color documents respectively.	<ul style="list-style-type: none">• Monochrome <u>TIFF</u>, PDF• Color <u>JPEG</u>, PDF See page 5-60.
Batch Scan	When you set it to [OFF], you can divide the scanned documents into page unit to send it as a separate e-mail respectively.	<u>ON</u> , OFF See page 5-59.

❑ When you press [Subject]

The underlined settings are the factory defaults.

Function	Description	Setting
Subject	When you set it to [ON], you can select the subject and the message attached to e-mail. The selected subject and message will be attached to all e-mail to be sent if you have not entered them for an e-mail transmission. The e-mail template can be registered using the web browser. (Refer to "E-mail settings" on the "Network Guide")	<u>ON</u> , OFF See page 4-7, 5-24.

Management settings

You can customize settings on your machine to match your needs.

Accessing the management settings

- 1 Press [Setting], [Management].
- 2 Set or change the selected items using [Prev] and [Next].

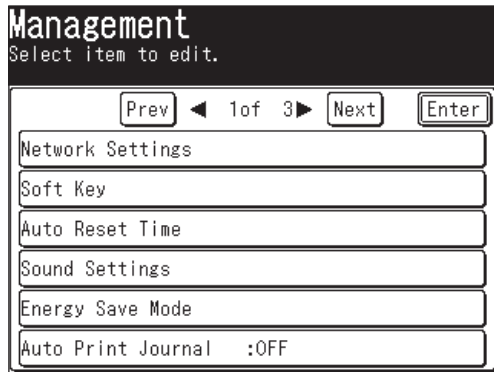

For details on each setting, refer to the following table:

- 3 When you are finished, press [Reset] to return to the standby mode.

The underlined settings are factory defaults.

Function	Description	Setting
Network Settings	You can configure the network settings to use your machine on the TCP/IP network.	For details of network settings, see “Network Guide” contained in this product.
Soft Key	You can change the “Soft keys” displayed in the standby mode.	See “Programming a soft key” on page 10-5.
Auto Reset Time	This sets the period of time before the copy/fax/scanner display returns to the standby mode. Copy and Scanner screens “Reset time” :When the machine does not operate for a set period of time after copying or scanning is completed, the selected settings are reset (returned to their original values). The reset time can be set. “Reset After Scan” :Setting it to [ON] resets the resolution, resizing, and other settings after the document is scanned. Setting it to [OFF] resets the values after the selected reset time has elapsed. Fax screen When the machine does not operate for a set period of time after faxing, the selected settings are reset (returned to their original values). You can set the reset time.	<ul style="list-style-type: none"> • Reset time 1 to 10 minutes: <u>3 minutes</u> • Reset After Scan ON <u>OFF</u> • Reset time 1 to 10 minutes: <u>3 minutes</u>

Function	Description	Setting																																				
Sound Settings	<p>You can set the various sounds.</p> <p>Buzzer and Key Touch Volume You can adjust the volume of the various sounds emitted by the machine.</p> <p>Key Touch Tone You can change the tone emitted when pressing the buttons. Different tones can be set for fax, copy and scanner.</p> <p>Fax Ringer You can set the ringer for fax reception even if the optional handset is not used.</p> <p>Complete beep You can confirm when each operation (copy, fax, e-mail, scan etc.) is completed by sound.</p> <ul style="list-style-type: none"> • Copy Complete When copying has finished • Transmission Complete ... When a fax/an internet fax/a scan to e-mail/a scan to folder/a scan to FTP have been sent • Rx Complete When a fax has been received • Rx Print Complete When printing a received document has finished <p>NOTE: Press [Test] to hear the selected sounds.</p> <hr/> <p>Paper Jam Alarm Sound an alarm tone when a paper jam occurs.</p>	<p>OFF Low <u>Middle</u> High</p> <ul style="list-style-type: none"> • Fax High Mid <u>Low</u> • Copy High Mid <u>Low</u> • Scanner High Mid <u>Low</u> <p>OFF ON</p> <p>OFF Type 1 Type 2 Type 3</p> <p>ON OFF</p>																																				
Energy Save Mode (See page 1-23)	<p>You can set the transition time to the energy save mode and whether to enable the transition time you set.</p> <p>NOTE: You can put the machine into energy save mode by pressing [Energy Save], regardless of this settings.</p> <hr/> <p>“Energy Save Mode” :When you set it to [OFF], [Energy Save Time] setting is disabled. To enter the energy save mode, press [Energy Save].</p> <hr/> <p>“Energy Save Time” :If the machine is not used for the period of time set here, it automatically switches to the energy save mode.</p>	<p>ON OFF</p> <p>1 to 100 minutes: <u>5 minutes</u></p>																																				
Auto Print Journal	<p>When turned [ON], the machine automatically prints a Tx & Rx Report once 100 faxes and e-mail have been sent or received.</p> <p>NOTE: Tx Report and Rx Report cannot be automatically printed.</p>	<p>ON OFF</p> <p>See “Printing journal report automatically” on page 13-6.</p>																																				
Journal Line Up	<p>When turned [ON], you can sort the report by the executed time. This can make it easier to locate specific jobs and to confirm job status. When turned [OFF], the report will be sorted by command.</p> <div style="border: 1px solid black; padding: 10px; margin: 10px 0;"> <p>Dallas Office Fax:123-456-7890 General dep. Account dep.</p> <p style="text-align: center;">** Fax Transmit Journal **</p> <p style="text-align: right;">May 5 2005 02:15pm</p> <p>P.1</p> <table border="1" style="width: 100%; border-collapse: collapse;"> <thead> <tr> <th>No.</th> <th>Name/Fax No.</th> <th>Mode</th> <th>Start Time</th> <th>Time</th> <th>Page</th> <th>Department</th> <th>Result</th> <th>Note</th> </tr> </thead> <tbody> <tr> <td>001</td> <td>New York Office</td> <td>Normal</td> <td>09/24 13:31</td> <td>0'22"</td> <td>0</td> <td></td> <td></td> <td>#T 4,1</td> </tr> <tr> <td>003</td> <td>New York Office</td> <td>Normal</td> <td>09/24 13:33</td> <td>0'12"</td> <td>1</td> <td></td> <td></td> <td># 0 K</td> </tr> <tr> <td>002</td> <td>Chicago Office</td> <td>Normal</td> <td>09/24 13:32</td> <td>0'12"</td> <td>1</td> <td></td> <td></td> <td># 0 K</td> </tr> </tbody> </table> </div>	No.	Name/Fax No.	Mode	Start Time	Time	Page	Department	Result	Note	001	New York Office	Normal	09/24 13:31	0'22"	0			#T 4,1	003	New York Office	Normal	09/24 13:33	0'12"	1			# 0 K	002	Chicago Office	Normal	09/24 13:32	0'12"	1			# 0 K	<p>ON OFF</p>
No.	Name/Fax No.	Mode	Start Time	Time	Page	Department	Result	Note																														
001	New York Office	Normal	09/24 13:31	0'22"	0			#T 4,1																														
003	New York Office	Normal	09/24 13:33	0'12"	1			# 0 K																														
002	Chicago Office	Normal	09/24 13:32	0'12"	1			# 0 K																														
Protect Passcode	<p>You can register the protect passcode required for using the security functions. To change the protect code, you must enter the old one first. Enter 0000 to delete the protect passcode.</p>	<p>No protect passcode is registered at shipment.</p>																																				

Function	Description	Setting
Department Management	You can limit who uses the machine for sending faxes and making copies by requiring input of a department code. Also, register the charge per 1 sheet of copy when you collect the copy charge.	See "Department management" on page 11-13.
Security Reception	You can use this function to receive and store the faxes in memory, but not print them. This function is useful when no one is in the office, for example, at night. You can print them later.	See "Security reception" on page 11-3.
Display Jobs in Queue	The number of out-of-paper receptions and copies waiting to be printed is displayed.	See "If paper runs out during fax reception" on page 3-17. See "Checking the copy print queue" on page 7-28.
Copy Protect	Prohibits copying. When pressed [ON], the display will not switch to the copy mode even if [Copy] is pressed. Fax & copy mode will not be possible.	ON OFF
PIN Mode	When pressing [Mode 1] or [Mode 2] if required to enter the PIN (personal identification number) for making a long distance call, the PIN will not appear in a journal, error message printout or a transmit confirmation report.	OFF Mode 1 Mode 2 See "PIN masking" on page 11-7.
Scan Lamp Sleep Mode	You can specify the sleep period of the scanner lamp to prolong its life. While scanner lamp is in the sleep mode, it will take a few moments to light the scanner lamp completely to scan a document.	ON OFF Start Time: 10:00 pm Reset Time: 06:00 am

Paper settings

You can customize the paper settings to match your needs.

Accessing the paper settings

- 1 Press [Setting], [Paper Settings].
- 2 Set or change the selected items.

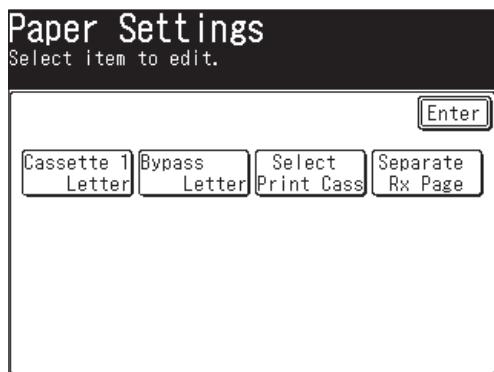

For details on each setting, refer to the following table:

- 3 When you are finished, press [Reset] to return to the standby mode.

The underlined settings are the factory defaults.

Function	Description	Setting
Cassette XX Paper	You can register the size of paper used in the cassette. Operation can be simplified by registering the paper size frequently used when using the cassette.	See "Setting the paper size" on page 1-30.
Bypass Tray Paper	You can register the type or size of paper used in the bypass tray. Operation can be simplified by registering the paper size frequently used when using the bypass tray.	See "Setting the paper size" on page 1-30.
Select Print Cassette	<p>You can set the cassette using range for cassette 1, cassette 2 and bypass tray respectively.</p> <p>"Not Use" : This cassette is not used for receiving faxes and copying. You can use it for PC printing and separate reception page.</p> <p>"Fax" : Use this cassette when receiving faxes or internet faxes, and printing a list.</p> <p>"Copy" : Use this cassette when copying.</p> <p>"Fax&Copy" : Use this cassette when receiving faxes or internet faxes, printing a list and copying.</p> <p>NOTE:</p> <ul style="list-style-type: none"> • Priority of cassette to be used is cassette 1 -> cassette 2 (option) -> bypass tray. • When you set "Separate Reception Page" to ON, you cannot select [Not Use] or [Copy] for the cassette specified in "Separate Reception Page". • 2nd cassette is displayed when installed in the machine. 	<p>Not Use</p> <p>Fax</p> <p>Copy</p> <p><u>Fax&Copy</u></p>
Separate Reception Page	Partition each received document by inserting a separator page.	See "Separator page" on page 3-57.

NOTE: The settings for the various functions set under Paper Settings are printed out in the System Settings List. (See page 13-2.)

Chapter

13

Report & Lists

Lists and journal reports	13-2
Activity journal	13-5
Setting the activity journal	13-5
Printing the activity journal manually.....	13-6
Setting the order on the activity journal	13-7
Transmission confirmation report	13-8
Setting the transmission confirmation report.....	13-8
Stored document list	13-9
Erased document notification.....	13-10

Lists and journal reports

The following table outlines the lists and journal reports that your machine can print out.

Name		Description
Address Book List		Lists the address book numbers, names and fax number/e-mail addresses you have stored. To print this list, press [Setting], [List], [Address Book], then [Yes].
Group List		Lists the address book numbers, name and fax number/e-mail address you have stored into group. To print this list, press [Setting], [List], [Group], then select the group name and press [Yes].
Command List		Lists the following items: <ul style="list-style-type: none"> • Command number • Address book numbers, fax numbers and e-mail addresses of the destination • Start time (dd, hh:mm format) • Note — The specified functions are printed. To print this list, press [Setting], [List], [Journal List], [Command List], then [Yes].
Journal Report	Tx Report	You can print the transmission report for the fax/internet fax/e-mail transmission. To print the report, press [Setting], [List], [Journal List], [Journal Report], [Tx Report], then [Yes].
	Rx Report	You can print the reception report for the fax/internet fax/e-mail reception. To print the report, press [Setting], [List], [Journal List], [Journal Report], [Rx Report], then [Yes].
	Tx & Rx Report	You can print the transmission and reception report for the latest 100 fax transaction and latest 100 internet fax/e-mail transaction. To print the report, press [Setting], [List], [Journal List], [Journal Report], [Tx&Rx Report], then [Yes].
Copy Settings List		Lists the current copy settings. To print this list, press [Setting], [List], [Settings List], [Copy Settings], then [Yes].
Fax Settings List		Lists the current fax settings. To print this list, press [Setting], [List], [Settings List], [Fax Settings], then [Yes].
Scanner Settings List		Lists the current scanner settings. To print this list, press [Setting], [List], [Settings List], [Scanner Settings], then [Yes].
System Settings List		Lists the current machine settings. To print this list, press [Setting], [List], [Settings List], [System Settings], then [Yes].
Function List		Prints the functions available on your machine. To print this list, press [Setting], [List], [Settings List], [Function List], then [Yes].

Name	Description
Store Doc. List	Prints how much memory each stored document is using. To print this list, press [Setting], [List], [Settings List], [Store Doc List], then [Yes].
Department List	Lists total communication time, printed pages of fax reception, total copy page, copy charge and the sum of copy charge. To print this list, press [Setting], [List], [Settings List], [Department List], then [Yes].
Macro List	Lists the each key's Macro key number and the name of the job stored in the Macro key. To print a program list, press [Setting], [List], [Settings List], [Macro List], then [Yes].
Program One-Touch List	Lists the program one-touch number, the address book number and the fax number, the time to start transmission, each program one-touch setting assigned to each key for program one-touch. To print the list, press [Setting], [List], [Other Lists], [Program One-Touch], then [Yes].
Fax Forward List	Lists the each transfer rule's identifier number, remote fax's number where you want documents to be transferred, ON/OFF setting, time period and auto print setting. To print a program list, press [Setting], [List], [Other Lists], [Fax Forward], then [Yes].
Cover Page	Prints a sample cover page. To print this list, press [Setting], [List], [Other Lists], [Cover Page], then [Yes].
Batch Tx Doc. List	Lists the box names and the documents' file numbers. To print this list, press [Setting], [List], [Other Lists], [Batch Tx Doc.], then [Yes].
Batch Tx Box List	Lists each box name, address book number and fax number and day and time the transmission should start. To print this list, press [Setting], [List], [Other Lists], [Batch Tx Box], then [Yes].
F-Code Box List	Lists each box's identifier number, box name (if any), sub-address, password, box type and each box's settings. To print this list, press [Setting], [List], [Other Lists], [F-Code Box], then [Yes].
F-Code Doc. List	Lists the each box's identifier number, box name (if any), box type and each file number (or document number) that is stored. To print this list, press [Setting], [List], [Other Lists], [F-Code Doc.], then [Yes].
Block Junk Fax List	Lists blocked phone numbers. To print this list, press [Setting], [List], [Other Lists], [Block Junk Fax], then [Yes].
Network Settings List	Lists the currently network settings. To print this list, press [Setting], [List], [Network Settings], then [Yes].

Name	Description
Folder Shortcut List	Lists each shortcut's identifier number, the shortcut name and the link destination. To print this list, press [Setting], [List], [Folder Shortcut], then [Yes].
FTP Shortcut List	Lists each shortcut's identifier number, the shortcut name and the link destination. To print this list, press [Setting], [List], [FTP Shortcut], then [Yes].
Tx confirmation report	Prints after document transmission.

Activity journal

Just as a checkbook records your daily financial transactions, your machine keeps an activity journal which records the 100 most recent fax, internet fax and scan to e-mail transactions. The activity journal lists the following information for each transaction:

- Assigned number, starting each day at 001 (fax only)
- Remote location called
- Resolution mode (fax only)
- Starting date and time
- Duration, in minutes and seconds (fax only)
- Number of pages (fax only)
- Department code (fax only) (See page 11-13.)
- Result of the call — If preceded by an asterisk (*), this signifies an ECM communication. If preceded by a pound (#), this signifies communication was via a highspeed V.34 modem.
- Any special operations — For example, “Manual” will appear if you made a fax call using an external telephone.

Setting the activity journal

Your fax machine will print the activity journal automatically after 100 transactions.

NOTE: Either [Tx Report] or [Rx Report] cannot be printed out automatically.

- 1 Press [Setting], [Management], [Auto Print Journal].

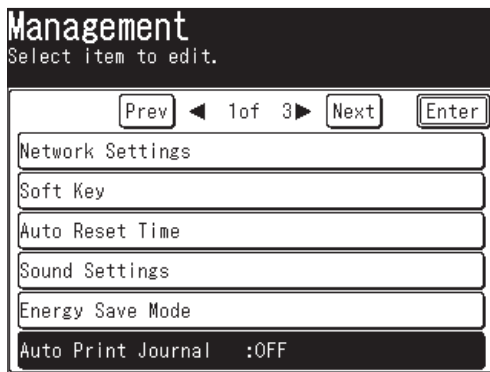

- 2 Select [ON] and press [Enter].

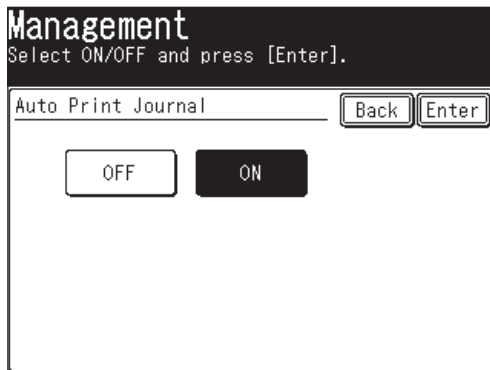

Printing the activity journal manually

To print an activity journal immediately without waiting for 100 transmissions to be completed:

- 1 Press [Setting], [List], [Journal List].

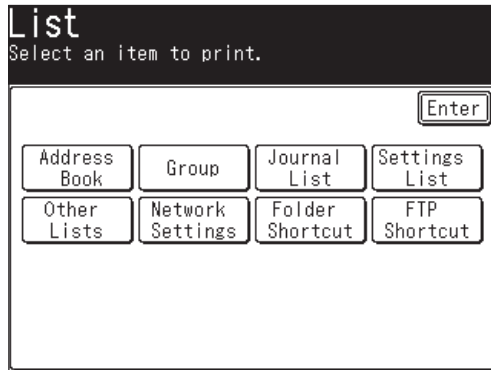

- 2 Press [Journal Report].

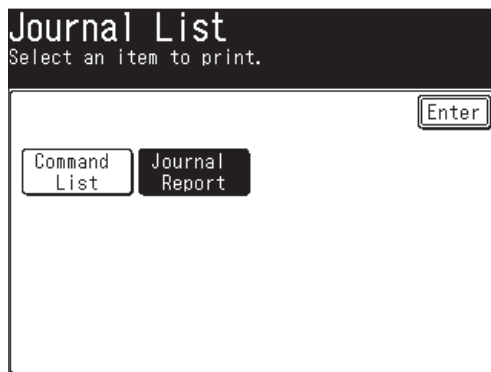

- 3 Select the journal type you want to print.
 - [Tx Report] prints fax/internet fax/scan to e-mail transmission reports only.
 - [Rx Report] prints fax/internet fax/scan to e-mail reception reports only.
 - [Tx & Rx Report] prints both fax/internet fax/scan to e-mail transmission and reception reports.
- 4 When the confirmation message appears, press [Yes] to print it.

Setting the order on the activity journal

Your machine will list every fax transmission (and attempt) on the activity journal. For example, if your machine has to redial a call the redials will appear on the journal.

If you want to list those activities by the executed time, you can change the order on the activity journal.

To change the order:

- 1 Press [Setting], [Management], [Next], [Journal Line Up].

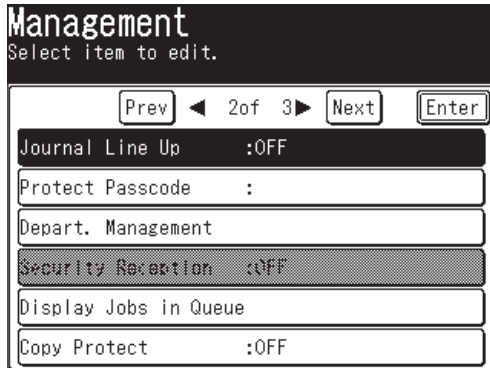

- 2 Select [ON] or [OFF].

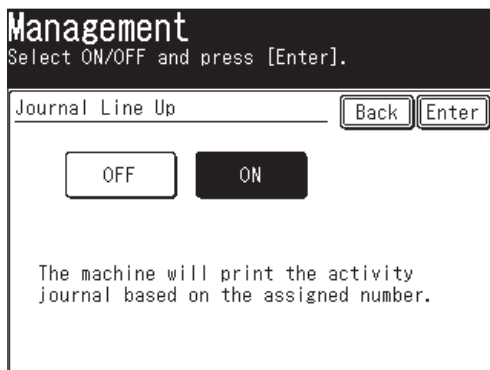

If you want the activity journal to print listing the transmissions by the executed time, press [ON].

Otherwise, The machine lists the fax transaction per command.

- 3 Press [Enter].

Transmission confirmation report

Setting the transmission confirmation report

Your machine can print a transmit confirmation report (TCR) after sending a fax or internet fax to any Group 3 fax machine. The TCR lists the following information for each communication:

- Date and time of the TCR's printout
- Resolution mode
- Number of pages
- Any special operations — For example, "BrdCast" will appear when you perform a broadcast transmission.
- Sample of the document — An reduced image of the first page of the document will appear.
- Destination to send (fax or internet fax)
- Starting date and time
- Sending results (of fax/internet fax)

To activate the transmission confirmation report:

- 1 Press [Setting], [Fax Settings], [Default Settings], [Tx Report].

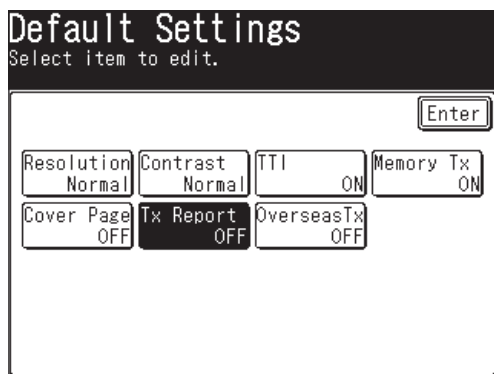

- 2 When you want to set the transmission confirmation report, set it to [ON]. [ON] and [OFF] toggle every time you press [Tx Report].

NOTE: • When you want to temporarily change the transmission confirmation report setting, perform the following procedure:
After the transmission has been completed the Tx Report setting will return to the default setting.

- 1 Press [FAX], [Others].
 - 2 Press [Tx Report] to change the setting.
[ON] and [OFF] toggle every time you press [Tx Report].
 - 3 Press [Enter].
- You can assign [Tx Report] to the soft key. See "Soft keys" on page 10-2.
-

Stored document list

Your machine can print a list of documents stored in memory. It will tell you how much memory each document is using.

The list information includes:

- Type — The document type, such as “Tx Doc”.
- Data (in Kbyte) — How much memory is used for the document.
- Page — Number of pages.
- Note — Other information, such as the command number.

To print the list of documents stored in memory:

Press [Setting], [List], [Settings List], [Store Doc List], then [Yes].

Erased document notification

- When documents stored in memory are accidentally erased, a notification will be printed when the power has been restored that outlines the erased documents information.
- The following is an example of a received file that has been erased. In addition, “Command erased”, “Erased Poll Documents” and “F-Code box document erased” may be printed.

NewYork Office Fax:123-456-4890

Documents Erased

P. 1 May 5 2005 02:15pm

No.	Name/Fax No.	Mode	Start Time	Time	Page	Result	Note
002	L.A Office	Normal	01, 12:13am	0'39"	1	# 0 K	
Erased	out-of-paper Rx docs.						
1	2	3	4	5	6	7	8

- | | |
|---|---|
| <p>1. No. — Number of the communication</p> <p>2. Name — Registered in the following order
 (1) TTI number registered for the destination name
 (2) Space</p> <p>3. Mode — Resolution used for the communication</p> <p>4. Start Time — Time the communication started</p> <p>5. Time — Time required for the communication</p> <p>6. Page — Number of pages received</p> <p>7. Result — Communications results.
 OK: Completed normally
 *: Communicated in ECM mode
 #: Communicated via super G3
 Error code: Finished abnormally
 (For information regarding error codes, refer to page 14-24.)</p> | <p>8. Remarks —
 Manual: Manual reception
 I-Fax: Internet fax reception
 PC-FAX</p> |
|---|---|

Maintenance & Troubleshooting

Maintenance	14-2
Cleaning tips	14-2
Cleaning the scanning area.....	14-2
Cleaning the ADF rollers.....	14-3
Cleaning the drum charge wire and the print head	14-3
Replacing the toner cartridge.....	14-5
Replacing the drum cartridge	14-7
Troubleshooting	14-9
Document jams	14-9
Paper jams.....	14-13
Displayed error messages.....	14-16
“Check Message” printouts.....	14-23
Error codes	14-24
Machine errors	14-26
Faxing errors.....	14-26
Scanning errors.....	14-27
Copying errors.....	14-27
PC printing errors.....	14-27
Local Scanner errors.....	14-28
Print quality problems.....	14-29
If you cannot solve the problem	14-31

Maintenance

Cleaning tips

To obtain optimal machine performance please follow these guidelines:

- **Clean your machine regularly!** Dust and dirt, especially around the fax machine's air vents can shorten your machine's life.
- **Always** unplug the machine before you clean it.
- **Never spray any cleaner directly onto your machine.** The drifting spray could damage the components inside.
- **Never try to clean sealed areas inside your machine.** They are sealed for both your safety and the safety of your machine.
- When cleaning the machine's exterior, use a mild cleaning solution sprayed onto a lint-free cloth.
- In areas you cannot reach with a swab, **always** use dry, dust-free compressed air to gently blow away dust and other material.

Cleaning the scanning area

F-560/F-520 model

- 1 Wipe the ADF glass with a clean, soft, lint-free cloth moistened with water.
- 2 Then use a clean, soft, dry, lint-free cloth to dry the glass.

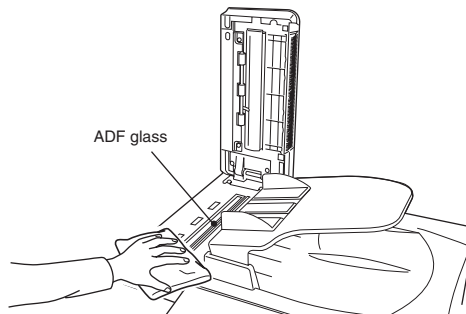

MXF-2030/MFX-1430 model

- 1 Wipe the document glass, ADF glass and document pad with a clean, soft, lint-free cloth moistened with water.
- 2 Then wipe it with a clean, soft, dry, lint-free cloth until it is clean and dry.

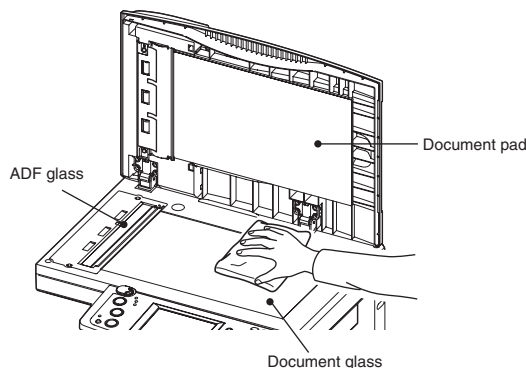

Cleaning the ADF rollers

If you are having document feeding issues, try this procedure:

- 1 Turn off the power and disconnect the power cable from the wall outlet.
- 2 Open the ADF cover.
- 3 Use a cloth moistened with a rubber roller cleaner to clean the face of the rollers.
Rotate the rollers by hand to clean the entire roller surface.

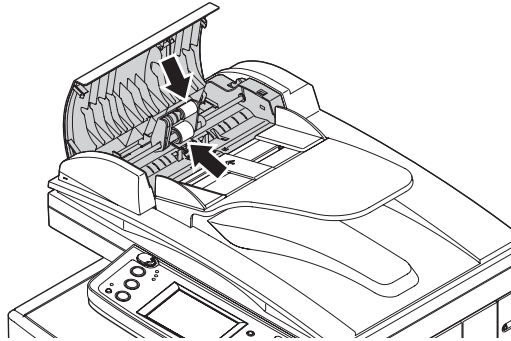

Cleaning the drum charge wire and the print head

When the following message appears on the display or if you are experiencing poor print quality, the charge wire needs to be cleaned.

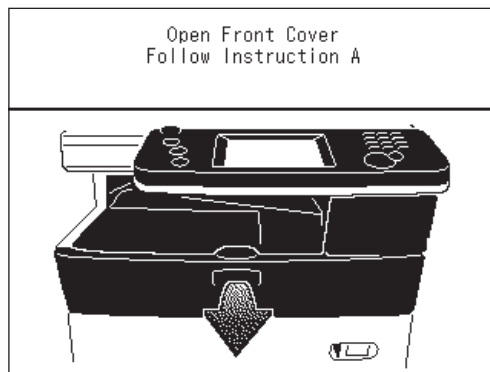

NOTE: Your machine will print approximately 100 pages after this message appears, after the maximum number of prints has been reached the machine will display a "Printer Not Usable" message and will not allow any further print jobs to take place. This will prevent your machine from becoming permanently damaged.

To clean the charge wire

- 1** Open the front cover.
- 2** Gently pull the blue cleaning rod toward you, making sure it fully extends. Then return the rod to its original position. This operation also cleans the print head.

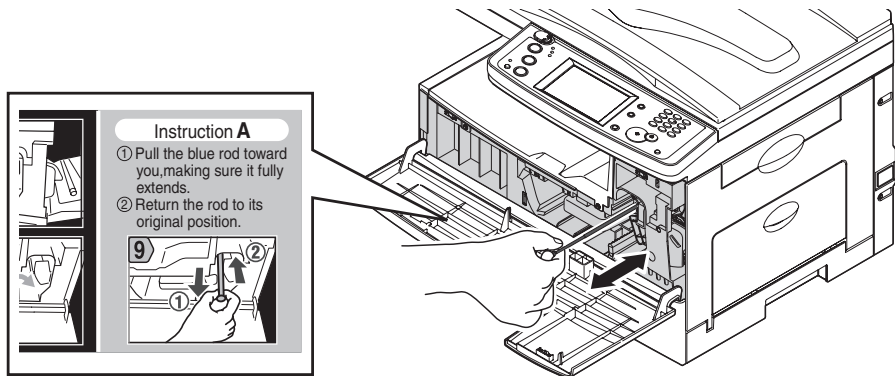

- 3** Close the front cover.

Replacing the toner cartridge

When the toner runs out, your machine will show “Toner should be replaced” on the display and it will not print until the toner cartridge is replaced.

To replace the toner cartridge:

- 1 Open the front cover.

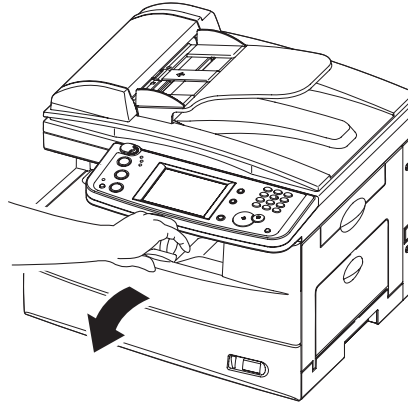

- 2 Turn the toner cartridge locking lever to the left (unlock position).

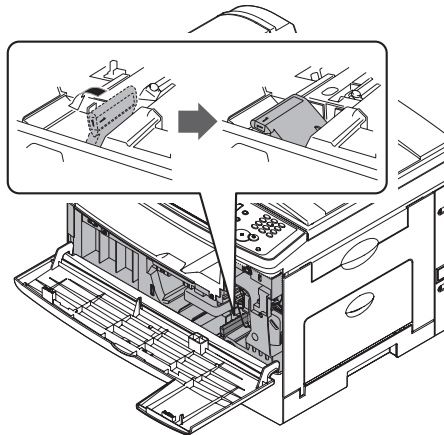

- 3 Pull the used toner cartridge out.

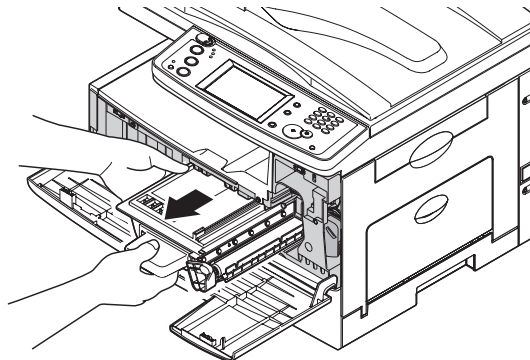

- 4 Unpack the toner cartridge from its carton. Then, holding the toner cartridge with both hands, gently shake it to distribute the toner evenly inside the cartridge.

NOTE: Do not touch the roller on the toner cartridge.

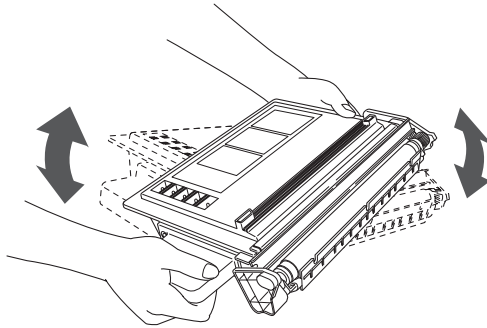

- 5 Slide the toner cartridge into the machine firmly until it locks into place.

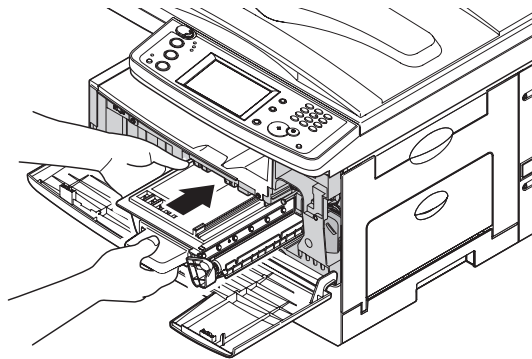

- 6 Turn the cartridge locking lever to the right until it locks into place.

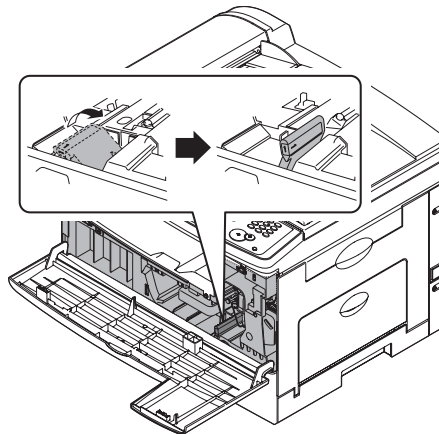

- 7 Close the front cover.

Replacing the drum cartridge

When the drum is near the end of life, the machine will show “The drum is low” on the display. You should obtain a replacement drum cartridge soon. When the machine shows “Drum should be replaced”, it cannot print until the drum cartridge has been replaced.

To replace the drum cartridge:

- 1 Open the side cover and front cover.
- 2 Turn the toner cartridge locking lever to the left (unlock position), then pull the toner cartridge out. The toner cartridge must be removed to replace the drum cartridge.

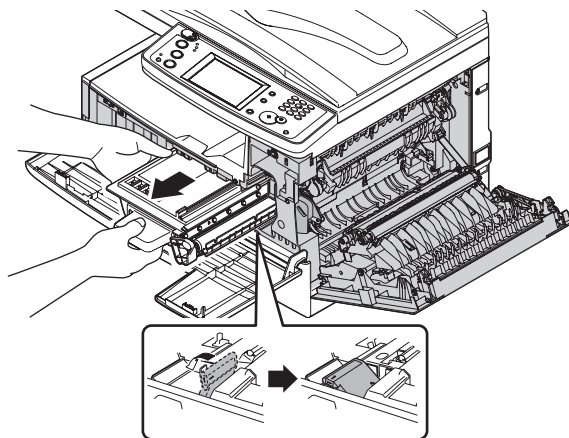

- 3 Pull the used drum cartridge out.

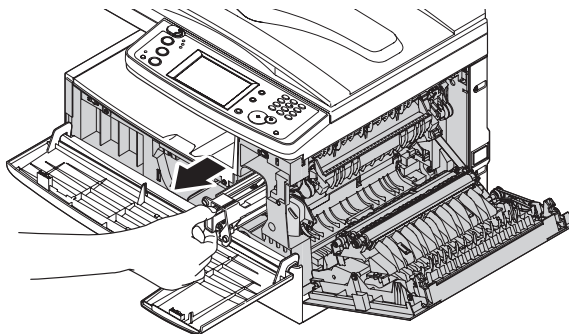

- 4 Unpack the new drum cartridge from its carton and slide it into the machine firmly until it locks into place.

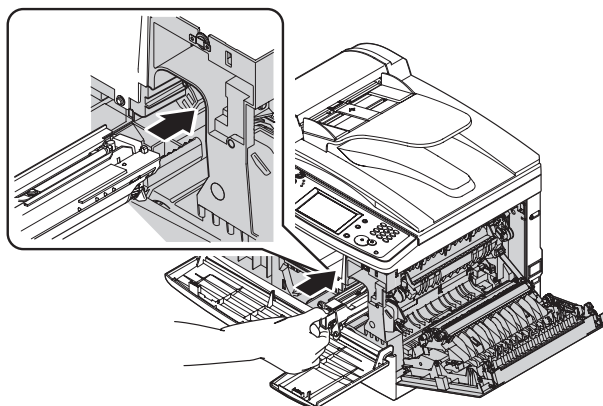

- 5** Reinstall the toner cartridge and turn the cartridge locking lever to the right until it locks into place.

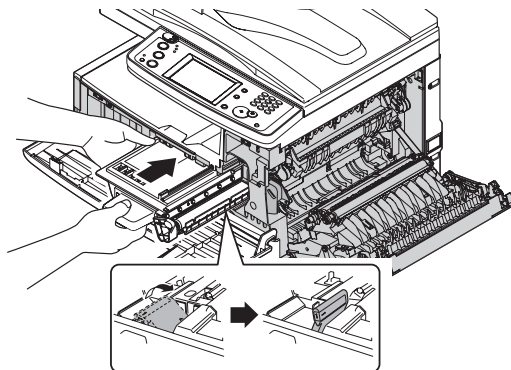

- 6** Close the front and side cover.

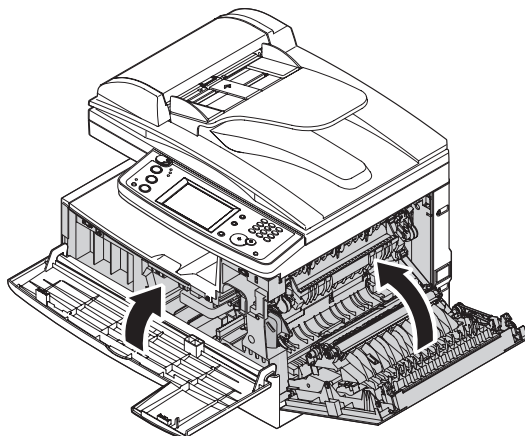

Troubleshooting

Document jams

Case 1:

If a document jams in the ADF, the following display will appear.

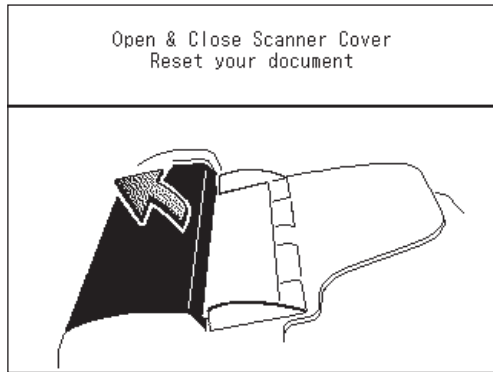

Also, if a document jam occurs during a quick memory transmission or real time transmission, the following message will print and detail which page has jammed.

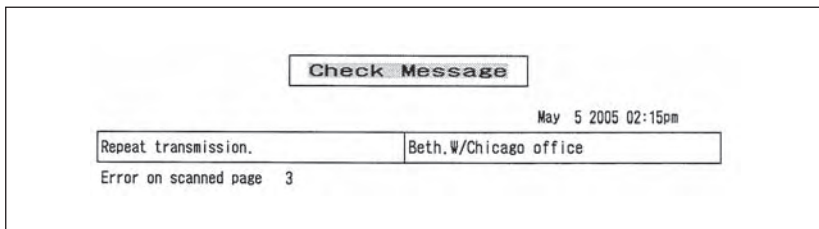

Case 2:

If a document jams while scanning into memory for sort copy or normal memory transmission, the machine will show:

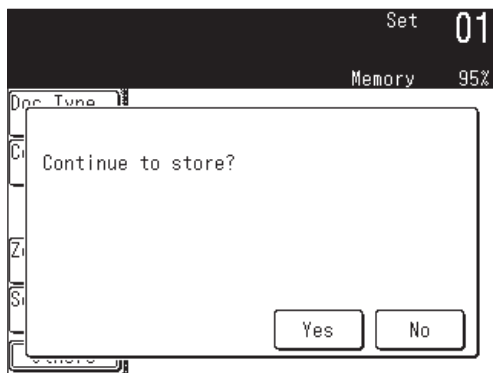

- 1 If you want to continue the operation, press [Yes] and proceed to step 2. To abort the operation, press [No].

NOTE: If the machine is left idle for 3 minutes, the machine will abort the operation automatically.

- 2 The machine will show which page (i.e., which page number) is jammed. Clear the document jam and reset the document in the ADF (you do not need to start the entire job over, simply start with the page that was jammed), then press [Start].

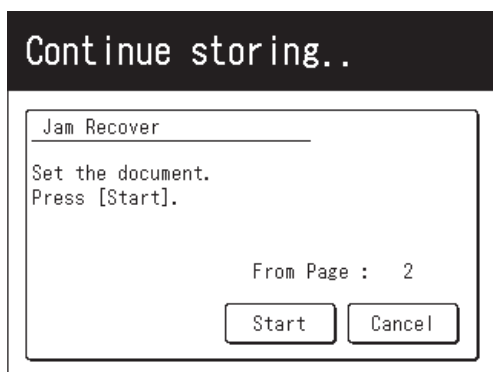

-
- NOTE:**
- If the machine is left idle for 3 minutes, the machine will begin to send or copy the document(s) it has stored in memory.
 - If you wish to cancel this operation, press [Stop]. The machine will delete the entire job that was stored in memory and then return to the standby mode.
-

Jam in the document feeder

- 1 Open the ADF cover.

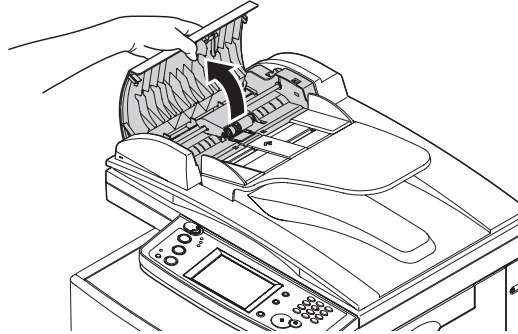

- 2 Gently remove the document from the ADF.
If you cannot remove it, turn the release knob to remove the jammed document.

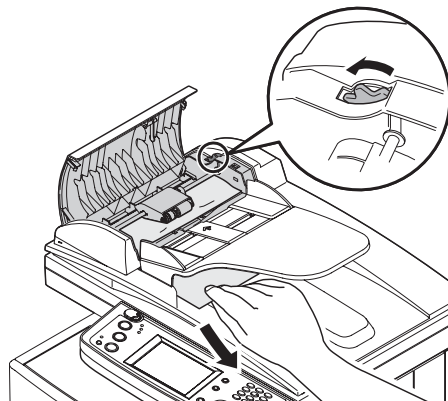

- 3 Close the ADF cover, making sure both sides are snapped down securely.

NOTE: To prevent document jam, use the document glass for wrinkled or torn documents.

Jammed in feed area

- 1 Open the platen cover. Open the ADF cover and turn the release knob to remove the jammed document.

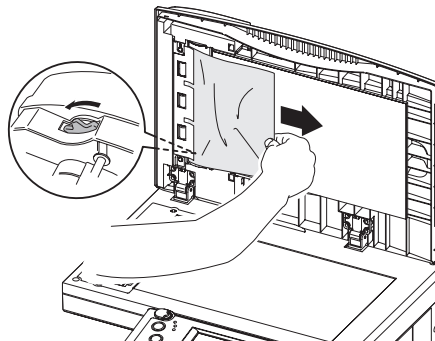

- 2 Close the platen cover and the ADF cover.

NOTE: To prevent document jam, use the document glass for wrinkled or torn documents.

Jammed in exit area

- 1** Open the platen cover. Gently pull the jammed document. If you cannot it, open the ADF cover and turn the release knob to remove the jammed document.

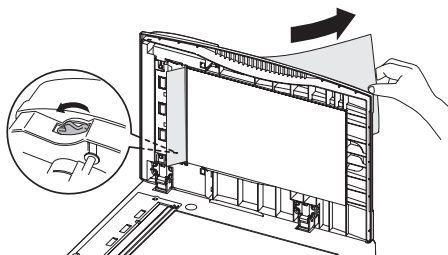

- 2** Close the platen cover and the ADF cover.

NOTE: To prevent document jam, use the document glass for wrinkled or torn documents.

Paper jams

If a paper jam occurs, the following display will appear.

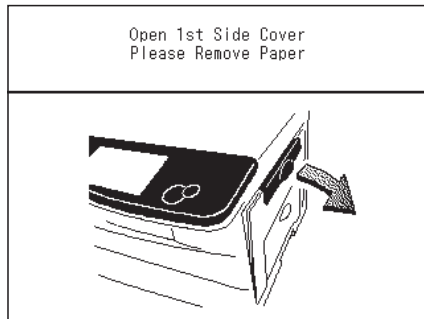

Follow these procedures to clear the paper jam.

If a paper jam occurs during fax reception, the machine will store the received document into memory and print them automatically once the paper jam has been cleared.

CAUTION: When you open the side cover to remove the paper, **DO NOT** touch the fuser roller. The fuser unit is very hot.

IMPORTANT: Do not touch the drum cartridge surface. Scratches or smudges will result in poor print quality.

Removing jammed paper

- 1 Pull the release lever to open the side cover.
If the optional second cassette has been attached, open the 2nd side cover as well.

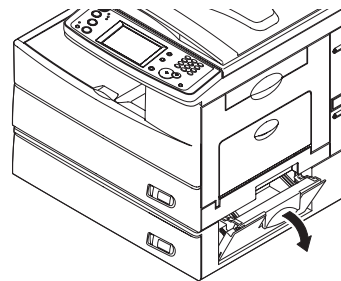
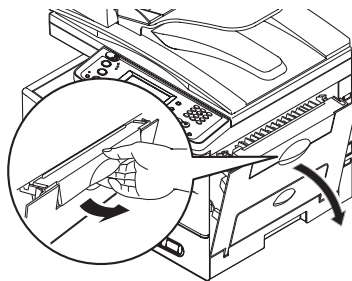

- 2 Carefully remove the jammed paper in the direction shown.

NOTE: Avoid getting loose toner on your hands and clothes when removing the jammed paper.

❑ Jam in the feed area

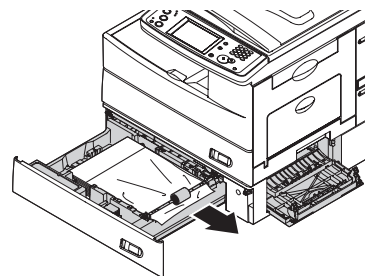
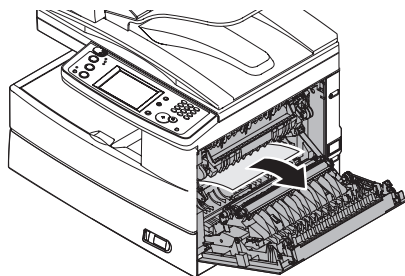

❑ **Jam in the fuser area**

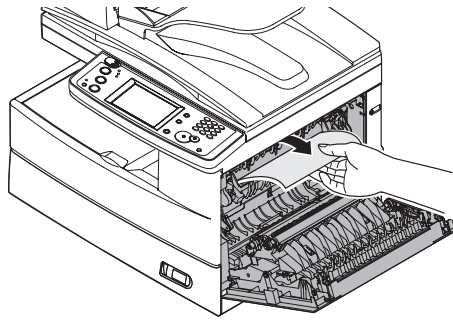

❑ **Jam in the paper exit area**

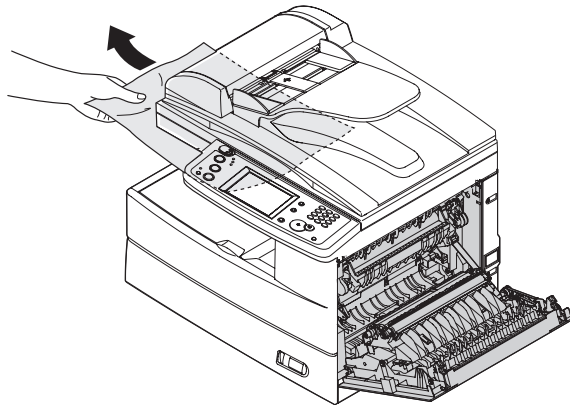

❑ **If the jammed paper was partially fed and you cannot remove it easily:**

- 3** Open the paper cassette. Pull it out completely, lifting the front part of the cassette up to release the cassette from the machine.

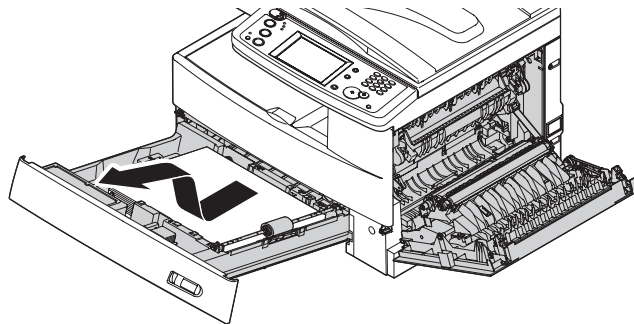

- 4** Carefully remove the jammed paper.

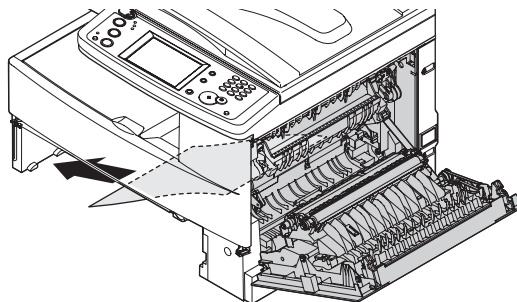

- 5 Close the side cover and insert the paper cassette. Lower the rear part of the cassette to align with the the slot of the machine, then insert it.

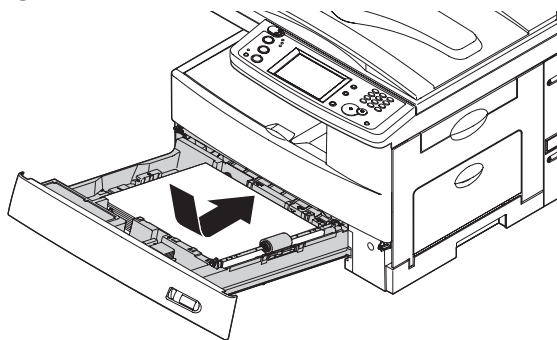

Displayed error messages

Occasionally, your machine encounters some trouble transmitting or receiving documents. When it does an alarm will sound alerting you to the issue. You can identify the problem with by reading the displayed or printed messages.

Message on the display	Description / Solution
[Sort] must be turned On when making a duplex copy.	You tried to set [Sort] to [OFF] while Duplex Copy. Duplex Copy should be combined with sort.
Add/Edit cannot be performed.	You cannot add/enter destinations to the Address Book while selecting other destinations.
ADF is unavailable. Set the document on the FBS glass.	You tried to make a Card Copy using the ADF. Use the document glass.
ADF used in the feeder command.	There is a delayed manual transmission to be sent. To edit the Fax Setting or run a Macro program, wait until the job is done or cancel the job.
Already stored.	You tried to select a number that has already been selected. Enter a different number.
An attachment cannot be scanned to the folder from which it was added.	You tried to scan to folder with files attached and save them to the same folder where the attached files are originally saved.
An I.D.Code is needed.	You cannot set "0000" as an I.D. Code for Security box.
An LDAP server has not been registered. Check the LDAP server settings.	The advanced search failed due to an internal machine error. Check the LDAP server setting again, and try the search again. For more information about LDAP server set up, refer to the "Network Guide".
An LDAP server has not been selected. Check the LDAP server settings.	
An LDAP server must be registered	LDAP server has not been set up. To use the advanced search, set up the LADP server on your machine prior to searching. For more information, refer to the "Network Guide".
Auto ratio is set.	Auto ratio is selected automatically. To specify the zoom ratio, press [Zoom] and enter your desired zoom ratio.
Box in use.	You tried to erase an F-Code box which contains at least one document. Erase the document(s), then try again.
Broadcast cannot be turned off.	You tried to set Broadcast to [OFF] after multiple destinations have been selected.
Calibrating Scanner	The scanner is warming up now.
Call Service :Code	An internal error has occurred. Contact your Muratec dealer.
Cannot change the setting for Rx separator cassette.	The cassette/tray you selected is used for separator page. Select other cassette/tray.
Cannot combine with Card copy.	Your selected function cannot be combined with card copy.
Cannot enter additional commands	The stored commands are full. Wait until one or more jobs are done.
Cannot find the domain	DHCP configuration failed. Check the Network setting. For more information, refer to the "Network Guide".
Cannot select mode during Fax&Copy	You tried to switch the mode to others while Fax&Copy mode. Changing mode in Fax&Copy is not available.

Message on the display	Description / Solution
Cannot store in a secure box.	You tried to store a document in an F-code Secure box. If you need to store documents, use an F-code Bulletin box.
Cannot use the same code for both Read/Write and Read Only.	You cannot use the same protect code for "Read/Write" and "Read Only". Enter a different one.
Check Paper Source	The selected paper is not suitable for copying or printing. Select other paper source.
Check the paper size. Open & Close Front cover.	The loaded paper does not match the paper registered in the machine. Set correct sized paper or change the paper size setting. Open and close the front cover to reset the printer.
Close XXX Cover	The cover indicated on the display is open or has not been closed securely. Close it properly.
Close XXX cassette	The paper cassette indicated on the LCD is open or has not been closed securely. Close it properly.
Close the Scanner Unit	The scanner unit is open. Close the scanner unit.
Communication error	A communication error disrupted the reception or transmission. If you were transmitting, press [Stop] to clear the error message and then re-try the transmission. If you were receiving a fax, try to contact the other person and have him/her re-try the transmission.
Communication in progress.	The function is not available during communication. Wait until it ends.
Contact service for printer option	An internal error has occurred. Contact your Muratec dealer.
Continue to store? [Yes] [No]	The document has jammed while being stored into memory. To continue storing press [Yes], to cancel the job press [No].
Copy protected	Copy is protected. To copy, set [Copy protect] to [OFF]. During copy protection, Macro program is disabled.
Copy reservation has been disabled.	Copy reservation is disable. Wait until the present job is completed.
Cover Open	Close XXX Cover The cover indicated on the LCD is open or has not been closed securely. Close it properly.
DHCP server did not respond.	DHCP configuration failed. Check the network connection. If the LAN cable is not connected, connect it to the machine to connect to the LAN. If the DHCP server is not installed on your network, turn off the "DHCP setting" and register the IP address manually. For more information, refer to the "Network Guide".
Dialing number has not been set.	You are selecting a non-registered address book number. Check the address book number and try again.
Document full	You tried to store a document in a Batch Tx box, but the machine has reached its capacity (40 documents). Delete unnecessary documents stored or use other Batch Tx box.
Document stored	You tried to erase a batch box which contains at least one document. To erase a batch box, erase all the documents stored in the box.
Drum should be replaced.	The drum cartridge has run out. Replace with a new drum cartridge.
Enter location.	No destinations are entered. Enter at least one destination to register the setting.
Enter the end day.	The end forwarding day is not entered in Fax forward setting.
Enter the end time.	The end forwarding time is not entered in Fax forward setting.
Enter the start day.	The start forwarding day is not entered in Fax forward setting.
Enter the start time.	The start forwarding time is not entered in Fax forward setting.

Message on the display	Description / Solution
Enter the sub-address	You tried to create an F-code box without entering a sub-address. Sub-address is a required field.
Error	The image transfer failed. Check the printed out "Check Message" to identify the error.
Feeder In Use	There is a manual delayed transmission reserved in the ADF. Wait until the job is finished, or cancel the delayed transmission by removing the document.
Follow Instruction A	Follow the instruction that will be displayed on the screen to clean the charge wire.
Incorrect passcode	The entered passcode is wrong. Enter the correct passcode.
Invalid Address Book Location!	A non-registered address book number is selected. Either choose another number or manually dial the number.
Invalid characters have been entered.	You entered invalid characters. To register a Shortcut, insert the PC name between "/" and ". To register a File Name, special characters such as "\", ":", ":", ":", ":", "<", ">" or " " cannot be entered. To register NetBIOS characters other than the alphabet and numbers between 1 to 9.
Invalid I.D.code	The F-code box I.D. code you entered is not valid. Try re-entering your F-code box I.D. code.
Invalid number!	You entered a number which is not valid for the current operation.
Invalid Paper Size	The selected paper is not suitable for duplex printing. Select other paper source. Select plain paper in the size of Letter or Legal.
Invalid parameters!	You entered an invalid value or pressed [Enter] without entering a value. – or – The advanced search failed due to an internal machine error. Check the LDAP server setting, and try the search again. For more information about LDAP server set up, refer to the "Network Guide".
Jam Recover. Set the document. Press [Start]. From Page : [Start] [Cancel]	You selected to continue the job. The machine is instructing you from which page to set the document. Set the document again from that page that the machine is indicating you and press [Start]. To cancel and finish the job, press [Cancel].
Lamp error. Call for service.	The scanner lamp is dim or not operating. Make repeated copies to help evaporate any internal moisture. If that doesn't resolve the problem, contact your Muratec dealer.
LDAP reference execution error	The advanced search failed due to an internal machine error. Try the search again.
Link Path is required.	You tried to register a shortcut without entering [Link]. To register a Folder or FTP server shortcut, you should enter the [Link].
Load XXX paper	Load the paper specified by the machine.
Load paper	There is no paper either in the cassette or in the bypass tray. Load paper.
Load paper for reception	The paper run out during fax reception. Load paper.
Load paper in the bypass tray	There is no paper either in the cassette or in the bypass tray. Load paper.
Load paper into the XXX cassette	There is no paper in the XXX cassette. Load paper in it.
Macro in use	You cannot press [Macro Program] while you are registering a Macro.
Mail transmission error	The transmission failed. Check the printed out "Check Message" to identify the error.
Memory full. Printing will resume when mem. is free. Press [OnLine] to stop.	There is not enough memory to store the print job. Wait until some reserved jobs are finished and the memory becomes free.
Memory overflow Rx	Memory has overflowed during the fax reception. Press [Stop] to return the standby screen.

Message on the display	Description / Solution
Memory overflow.	You tried to enter more pages into memory than your machine could store.
Memory overflow. Number of stored page: Store these pages? [Yes] [No]	You tried to store more pages into memory than your machine could store. Press [Yes] to keep the scanned pages in memory, or press [No] to delete all pages stored during this operation. The display shows how many pages are stored.
Name is required	You need to enter a name for the registration.
No command stored	You pressed [Fax Cancel/Job Confirm.] to review upcoming commands, but your machine has no command stored.
No department codes have been registered	To set the department management on, first register the department codes.
No document stored	You tried to print a document from memory, but your machine has no documents in storage.
No Drum Cartridge	The drum cartridge is missing or has not been properly installed in your machine. Please properly install the drum cartridge.”
No Network Connection	The machine is not connected to the network. Check the network cable or the settings. For more information, refer to the “Network Guide”.
No paper type set on the PC On XXXX Please set paper (Letter Plain) To cancel select [Cancel]	The cassette/tray selected for printing is empty. Please set the paper indicated in the message and print your job, or press [Cancel] to cancel.
No paper type set on the PC Please set paper (XXXX) To cancel select [Cancel]	The paper selected for printing is not set to the machine. Please set the paper indicated in the message and print your job, or press [Cancel] to cancel.
No polling document	You tried to print out or delete a polling document when there is no polling document in memory.
No protect passcode	To protect the Department Management, Security reception or to mask the PIN, you need to set the protect passcode in advance.
No report	You requested an activity journal or transmit confirmation report, but your machine has no record of any fax jobs occurring.
No Toner Cartridge	The toner cartridge is missing or has not been properly installed in your machine. Please properly install the toner cartridge.
Not enough memory	The machine cannot store documents into memory any more. Delete unnecessary documents stored or wait until a reserved job is done.
Not registered	You pressed a key which is not programmed with any command. – or – You tried to delete a non-registered item. Non-registered items cannot be deleted.
Nothing has been selected.	You tried to press [Enter], when nothing has been selected. To change the settings or to select destinations, first select items from the list, then press [Enter].
Nothing has been stored.	You tried to display the jobs in queue, when there is no job.
Open & Close Scanner Cover Reset your document	A document has jammed in the ADF. Follow the instruction on the display and removed the jammed document.
Open front Cover	Open the front cover. The cover position is located on the display.
Paper Count Error	The scanned page numbers for the first side and the back side of the documents did not match. Fan the document to prevent more than one sheet being drawn through at a time, and try the operation again.

Message on the display	Description / Solution
Paper size error for XXXX On XXXX Please set paper (YYYY) To cancel select [Cancel]	The cassette/tray selected for printing has no suitable paper for printing the job. Please set the paper indicated in the message and print your job, or press [Cancel] to cancel.
Paper supply empty.	There is no paper that fits the copying document. Select on which paper to copy or load paper.
PC Printing Canceled	In PC printing, the size of paper in the paper cassette does not match up the paper size you specified by the printer driver. Press [Stop] to cancel a print job. Then load the correct paper size and try printing the document again.
Phone connection terminated	The telephone connected to the machine is hanging up. Hang it down.
PIN has not been registered.	You selected "Mode1" in the PIN mask feature and tried to call an address book number in which no PIN has been entered, or to call using numeric keys without a PIN. Enter a PIN.
Please enter a value between 25-100%	The value you entered exceeds the Zoom range. Enter a value within the range.
Please enter a value between 25-400%	The value you entered exceeds the Zoom range. Enter a value within the range.
Please enter text.	You cannot view the text when there is no text entered. Enter the text in advance.
Please install the drum cartridge correctly.	The drum cartridge is missing or has not been properly installed in your machine. Please properly install the drum cartridge.
Please install the toner cartridge correctly.	The toner cartridge is missing or has not been properly installed in your machine. Please properly install the toner cartridge.
Please Remove Paper	Paper has jammed in the machine. Follow the instruction on the display and removed the jammed paper.
Please set up Security Reception	The Security Reception is not set up. To use this function set up Security Reception in advance.
Please Supply Paper	There is no paper either in the cassette or in the bypass tray. Load paper.
Please wait...	Your machine's printer is either warming up or busy. Please wait until the machine is finished printing and then re-try your command or operation.
Preparing	Your machine's printer is either warming up or busy. Please wait until the machine is finished printing and then re-try your command or operation.
Press [Stop] to end the job.	Document remains from the operation prior to the interrupt. Press [Stop] to discharge the document.
Press the Fax Cancel key to stop the transmission.	[STOP] is pressed during fax transmission. Cancel the transmission by [Fax Cancel/Job Confirm.].
Printer in use	The machine cannot execute the job while printing. Wait until the printing is finished and re-try the operation.
Printer Jam	Paper has jammed. Follow the guidance on the display and remove the paper.
Ratio is set to 100%.	The zoom ratio is set to 100%. To change the zoom ratio, set it again.
Real time transmissions cannot be archived.	You tried to send a fax using real time transmission or set memory transmission to [OFF] when the archive function is set up. To archive the document, use memory transmission.
Real time TX in progress. Cannot print.	The machine cannot print out the job until the current communication finishes. Please wait.
Replace the drum.	The drum cartridge has run out. Replace with a new drum cartridge.
Reset the document	Remove the document from the ADF, and set them again.

Message on the display	Description / Solution
Rx document stored	To set the security reception to [OFF], first print out the stored security received document.
Scanner Adjusting	Your machine's scanner is preparing. Please wait until the machine is ready.
Scanner in use	The machine cannot execute the job until the current job finishes. Please wait.
Select Paper Size	The selected paper is not suitable for the document. Select other paper.
Select paper source	There is no paper that fits the copying document. Select on which paper to copy or load paper.
Select the bypass paper that cannot be used for Rx	The paper in the bypass tray cannot print out a received fax. To use the bypass tray paper as a separator page, change the paper source in the bypass tray.
Server Initializing	The machine's network is now preparing. Please wait until it is ready.
Server issue. Call for service :error code	An internal network error has occurred. Contact your Muratec dealer.
Set document in the ADF.	You tried to make a [2 → 2side] or [2 → 1side] copy using the document glass. Those copy are only available from the ADF.
Set individual forwarding numbers first	The Fax Forward is not set up. To use this function, set up the forwarding condition in advance.
Set paper: XXXX	There is no paper in the bypass tray. Load the paper indicated on the display.
Set the individual forwarding numbers first	The Fax Forward is not set up. To use this function set up the forwarding condition in advance.
Set the Read/Write Code first.	You tired to create a "Read Only" protect code prior to "Read/Write" code. Create a "Read/Write" code first.
Setting must be changed from the browser	When the machine is on the Network, you cannot set Fax Forwarding from the machine side. Use the browser for the setting.
Supply Separator Paper in XXXX	The paper for separator reception has run out. Load paper in the designate cassette/tray.
The drum is low.	Your drum will need to be replaced soon. Please contact your Muratec dealer to purchase a new drum cartridge.
The following data is required: Fax or e-mail	The fax number or e-mail address is not registered to the Address Book. Either fax number or e-mail address must be registered.
The following data is required: Fax or e-mail, PIN number	The fax number with PIN number or e-mail address is not registered to the Address Book in PIN mask mode 1. Either fax number or e-mail address must be registered. For fax numbers, the PIN number must also be entered after entering the fax number and an "*" (asterisk).
The LDAP server cannot be found. Check the LDAP server settings.	The advanced search failed due to an internal machine error. Check the LDAP server setting again, and try the search again. For more information about LDAP server set up, refer to the "Network Guide".
The NetBIOS name entered is already in use.	The NetBIOS name conflicts with other device. Contact your Network Administrator.
The number of file attachments and/or file size limit has been exceeded. Please delete attachments until you reach the acceptable limit.	You can add up to 10 network files (or up to 10 MB worth of files) to the scanned job. Delete files so that it meets the limit.

Message on the display	Description / Solution
The number of the browse results exceeds the limit.	You browsed a folder where too many files or folders are located. To scan to the folder, register the folder as a shortcut using the [Keypad] or select another folder. To attach files from the folder, copy the files to a new folder and attach them.
The numeric keypad cannot be used.	You cannot use numeric keys while selecting group members.
The storing process has not finished.	The machine cannot execute the job until the current job finishes. Please wait.
The toner is empty.	Toner is empty. Replace with a new toner bottle.
The toner is low.	Your machine is almost out of toner. Please contact your Muretec dealer soon to purchase a new toner cartridge.
The value entered exceeds the limit. Please enter a value within the listed range.	You entered a value or number that exceeds the range. Confirm the range on the display and enter it again.
There are no vacant numbers.	You have already registered 300 locations to the Address Book. To register a new location, first delete the unnecessary locations first.
There is no applicable data.	You selected a key on the index, to which no destination is categorized.
This function cannot be used.	You selected a function that is currently not available. Change the function you set prior to this function or cancel this function.
This Resolution cannot fit specified Zoom value.	You try to set a resolution that is not available in the set zoom ratio. Change either the resolution or the zoom ratio to do the job.
This setting is protected	The department management setting is protected. To change the setting, release the protection.
To initialize IP address you must shutdown.	IP address is entered or edited. Power off and then on to save the setting.
Toner should be replaced.	Toner is empty. Replace with a new toner bottle.
Too many characters	You entered more characters than the limit. Re-enter them so that it contains the limit.
Too many locations.	You entered more location than the limit. Re-enter them so that it contains the limit.
TTI data has not been registered	The Transmit Terminal Identifier (TTI) is not registered. To select the TTI, register the TTI in advance.
Unable to delete.	The job you selected was carried out before deleting.
Use the scanner glass	You tried to make a zoom up copy using the ADF. To make a zoom up copy, use the document glass.

“Check Message” printouts

When there is a problem with your machine detects an error, it produces an error printout headed by the words “Check Message”. This printout lists the following information about the fax transaction:

- The resulting error code (See “Error code” next page.)
- A communications error message (See “What error messages can mean” below.)
- The TTI (or phone number) of the fax machine with which your machine had attempted to communicate.

What error messages can mean

The error messages on Check Message printouts can mean a variety of things. Here is a brief summary:

Error message	Possible meanings
Check condition of remote fax.	<ul style="list-style-type: none"> • Remote machine malfunctioned • No “Handshake” signals from remote fax • Wrong phone number reached
Repeat transmission.	<ul style="list-style-type: none"> • Poor phone line conditions • No “Handshake” signals from remote fax • Document misfeed or miscount • Unable to reach remote machine after attempting specified number of redial tries
Line is busy.	<ul style="list-style-type: none"> • Remote machine’s line was busy • Remote machine’s line didn’t answer
Check received documents.	<ul style="list-style-type: none"> • Remote confirmation signal not received from remote fax • Poor line conditions caused a poor image
Specified attached file(s) was not found.	<ul style="list-style-type: none"> • Network setting is not set up • There is no connection to the network • The user name or password is not entered correctly • The folder is not shared • The folder link is not entered correctly
Could not connect to the location.(Folder)	<ul style="list-style-type: none"> • Network setting is not set up correctly • There is no connection to the network • The user name or password is not entered correctly
Could not connect to the location.(FTP)	<ul style="list-style-type: none"> • The folder is not shared or the folder is write-protected • The folder link is not entered correctly
Please confirm the size of attached file(s)	<ul style="list-style-type: none"> • The attached files exceeds the limit. (Should be within 10MB.)
Memory full.	<ul style="list-style-type: none"> • Remote fax’s memory is full
Dialing number is not set.	<ul style="list-style-type: none"> • Stored phone number failed to dial properly
Stopped.	<ul style="list-style-type: none"> • Someone pressed [Stop] at the remote fax in the middle of the “Handshake”

Error codes

Dialing errors

- D.0.3,**
D.0.8 The remote unit didn't respond, the call couldn't be completed or [Stop] was pressed while dialing. Re-try the call. If your machine repeats the message, call the remote fax unit's operator and verify that unit is operating properly.
- D.0.2** The remote unit is busy. Try the call again.
- D.0.6,**
D.0.7 Either the remote unit didn't respond, the call somehow didn't go through or [Stop] was pressed while dialing. Try the call again.

Reception errors

- R.1.1** The calling fax machine didn't respond to your fax machine. This can happen if someone dials a wrong number or if the remote machine restricts access through use of a passcode.
- R.1.2** The two fax machines were incompatible. Your machine sends and receives only ITU-T Group 3 fax communication, the industry standard since the early 1980s.
- R.1.4** [Stop] was pressed on the receiving fax machine.
- R.2.3** Poor phone line conditions made fax communication impossible. Call someone at the remote machine's location.
- R.3.1** The sending fax machine detected too many errors from the receiving fax machine.
- R.3.3** The sending fax machine is incompatible or had a document feeder problem during transmission.
- R.3.4** Poor phone line conditions may have prevented your fax machine from properly printing some or all of the pages it received.
- R.4.1** The machine received too much data, overloading the memory.
- R.4.2** Either the line disconnected before transmission or the transmitting fax machine needs maintenance.
- R.4.4** The machine has reached its memory capacity.
- R.5.1,**
R.5.2 ECM reception failed (perhaps due to line noise).
- R.8.1** A compatibility error occurred.
- R.8.10** Line noise or other problems prevented line probing.
- R.8.11** The fax machine timed out while waiting for the retrain signal.

Transmission errors

- T.1.1** The remote fax machine didn't respond to your machine. Call someone at the remote machine's location.
- T.1.4** [Stop] was pressed during transmission.
- T.2.1** Either the phone line disconnected during transmission or fax communication became impossible due to bad phone line conditions. Try the call again.
- T.2.2** The two fax machines were incompatible. Your machine sends and receives only ITU-T Group 3 fax communication, the industry standard since the early 1980s.
- T.2.3** Bad phone line conditions made fax communication impossible. Conditions can change rapidly, so try the call again later.

- T.3.1** The page counter in your fax machine detected a document feeder error during transmission. Carefully reset the document into the feeder and re-try the call.
- T.4.1** The telephone line disconnected during transmission because of excessive modem errors or because the remote unit ran out of paper. Try the call again.
- T.4.2** After transmission began, poor line conditions developed. Try the call again.
- T.4.4** Poor line conditions prevented transmission. Try the call again.
- T.5.1,**
T.5.2,
T.5.3 ECM transmission failed (perhaps due to line noise). Conditions can change rapidly, so try the call again later.
- T.8.1** A compatibility error occurred.
- T.8.10** Line noise or other problems prevented line probing.
- T.8.11** The remote fax machine didn't complete the equalizer training phase.

Machine errors

Symptom	Suggested solutions
The display shows nothing, and the keys are not working.	Check that the power switch is turned on.
The machine is not activated when the power switch is turned on.	Check that the power cord is connected properly.
The machine beeps and shows an error message.	See “Displayed error messages,” on page 14-16.
Documents jam frequently	<ul style="list-style-type: none"> • Check for the ADF cover is closed properly. • If there is a foreign matter in the ADF, remove it. • Ensure that the document is an acceptable weight. (See “Document handling,” page 1-24.) • Clean the ADF rollers (see page 14-3.)
Paper Jams Frequently	<ul style="list-style-type: none"> • Ensure that the paper is an acceptable weight. (See “Paper handling,” page 1-26)

Faxing errors

Symptom	Suggested solutions
Cannot send	<ul style="list-style-type: none"> • Check that the phone line is connected properly. • Check that the number or the e-mail address stored in your address book is correct. • Make sure that the machine is in fax mode. If not, change to the mode to the fax mode by pressing [FAX]. • Check that the network cable is connected properly. • Check that the network setting is made up properly.
Cannot stop transmission	Your machine cannot cancel a transmission by pressing [Stop]. To cancel a transmission, press [Fax Cancel/Job Confirm.] and select a job you want to cancel, then press [Enter]. (See Chapter 6 “Reviewing or canceling commands” for more details.)
Cannot receive automatically	<ul style="list-style-type: none"> • Check that the phone line is connected properly. • Check that the machine is in the automatic receiving mode (page 3-16). • The memory may be full. If there is no paper in the cassette, set a paper to print the received document stored in the memory.
Cannot receive manually	<ul style="list-style-type: none"> • Make sure that the external phone is attached to your machine to receive a fax manually. • In manual receive mode, you must press [Start] before you hang up the phone. • The memory may be full. If there is no paper in the cassette, set paper.
Cannot store a document into memory	<ul style="list-style-type: none"> • Make sure that the machine is in fax mode. If not, change to the mode to the fax mode by pressing [FAX]. • The memory may be full. If there is no paper in the cassette, set the paper to print the received document stored in the memory. • The number of document can be stored in the current operation is full. Delete unnecessary documents.

Scanning errors

Symptom	Suggested solutions
Cannot browse a folder / file	<ul style="list-style-type: none"> • Check that your browsing folder / file is in the same segment with your machine. • Check that your folder / file is under a shared folder that name contains 12 characters of less. • Check that the link to your browsing folder is 100 characters or less in length. • Check that the link to your browsing file is 128 characters or less in length.
Cannot scan a document	<ul style="list-style-type: none"> • Check that the network cable is connected properly. • Check that the network setting is made up properly. • Check that the e-mail address stored in your address book or the folder/FTP shortcut is correct. • Make sure that the machine is in scan mode. If not, change to the mode to the scan mode by pressing [SCAN].
Scanned image looks dirty	<ul style="list-style-type: none"> • The document glass or ADF glass may be dirty. Clean the glass (see page 14-2.) • Change the scanning contrast by pressing [Contrast]. • Change the scanning resolution by pressing [Resolution]. • Change the document type by pressing [Doc.Type].
A file name or folder name that contains a special character is not correctly displayed and/or cannot open or delete it.	<p>The code page currently using in your Windows does not compatible with a special characters which can be used in your machine.</p> <p>To solve this issue, change the currently using code page to code page 850 on your Windows.</p> <p>IMPORTANT:</p> <p>To change the code page, you will modify Windows registry. Before you modify the registry, make sure to back it up and make sure that you understand how to restore the registry if a problem occurs. For information about how to back up, restore, and edit the registry, refer to the article number 256986 in the Microsoft Knowledge Base (http://support.microsoft.com/kb/256986/en-us).</p> <p>⚠ WARNING:</p> <p>If you use Registry Editor incorrectly, you may cause serious problems that may require you to reinstall your operating system. We cannot guarantee that you can solve problems that result from using Registry Editor incorrectly. Use Registry Editor at your own risk.</p> <p>To change the code page on your Windows:</p> <ol style="list-style-type: none"> 1 On your computer, click Start, click Run, type regedit, and then click OK. 2 Locate and double-click the following registry key. HKEY_LOCAL_MACHINE\System\CurrentControlSet\Control\Nls\Codepage\OEMCP 3 In Value data, type 850, and click OK.

Copying errors

Symptom	Suggested solutions
Cannot make a copy	<ul style="list-style-type: none"> • Make sure that the machine is in copy mode. If not, change to the copy mode by pressing [COPY]. • Make sure that the document is loaded correctly. If placing the document on the document glass, the side to be copied should be face down. If placing the document in the ADF, the side to be copied should be face up.
Copy quality is poor	See "Print quality problems," on page 14-29.

PC printing errors *

Symptom	Suggested solutions
Cannot print from your computer	<ul style="list-style-type: none"> • The USB cable is not connected properly. (When using as a local printer) Check the cable connection. • Check that the network cable is connected properly. (When using as a network printer) • Check that the network setting is made up properly.(When using as a network printer) • The port setting is incorrect. Check the printer port setting in your computer. • The applicable printer driver may not be installed properly. Reinstall the printer driver.
Printing is too slow	<ul style="list-style-type: none"> • Computer may not have enough memory. Install more RAM in your computer. • The print job is large or complex. The machine takes a lot of times when printing a large print jobs. Please wait until the machine finishes the job.
Print quality is poor	See "Print quality problems," on page 14-29.
The printing option does not effect for the printouts.	Some software applications will overwrite the option set on the printer property page. Choose your printing options from the application.







* In order to use your machine as a local or network printer you should have the applicable print driver installed from CD supplied with your machine.



Local Scanner errors *

Symptom	Suggested solutions
Cannot scan a document	<ul style="list-style-type: none">• The TWAIN driver may not be installed properly. Reinstall the printer driver.
“Muratec Color TWAIN Scanner” does not appear in the list of the available scanner device on your application software.	<ul style="list-style-type: none">• The TWAIN driver may not be installed properly. Reinstall the printer driver.
Scanned image looks dirty	<ul style="list-style-type: none">• The document glass or ADF glass may be dirty. Clean the glass (see page 14-2.)• Change the scanning contrast by pressing [Contrast].• Change the scanning resolution by pressing [Resolution].• Change the document type by pressing [Doc.Type].

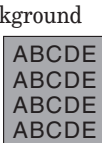
* In order to use your machine as a local scanner you should have the driver installed from CD supplied with your machine.

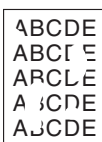
Print quality problems

<p>Pages are blank</p> 	<ul style="list-style-type: none"> The document is loaded incorrectly. Set the document facing up on the ADF or facing down on the document glass.* The toner cartridge may be defective. Remove the toner cartridge and check it for damage. If the problem persists, replace the toner cartridge.
<p>Pages are black</p> 	<ul style="list-style-type: none"> The drum charge wire may be dirty. Open the front cover. To clean the drum charge wire, pull the blue rod toward you, making sure it fully extends. Then return the rod to its original position. (See page 14-4.) The toner cartridge may be defective. Remove the toner cartridge and check it for damage. If the problem persists, contact Muratec dealer.
<p>Printouts are too light</p> 	<ul style="list-style-type: none"> Contrast selected was too light. Select a darker contrast setting. The toner cartridge may be out of toner, or the toner may be very low. Replace the toner cartridge. The paper is damp. Replace the paper.
<p>Printouts are too dark</p> 	<ul style="list-style-type: none"> Contrast selected was too dark. Select a lighter contrast setting.
<p>Printouts have a blurred background</p> 	<ul style="list-style-type: none"> The document glass* or ADF glass is dirty. Wipe the glass with a dry soft cloth. The drum charge wire may be dirty. Open the front cover. To clean the drum charge wire, pull the blue rod toward you, making sure it fully extends. Then return the rod to its original position. (See page 14-4.) The toner cartridge may be defective. Remove the toner cartridge and check it for damage. If the problem persists, replace the toner cartridge.
<p>Printouts are of uneven density</p> 	<ul style="list-style-type: none"> The drum cartridge may be defective. Remove the drum cartridge and check it for damage. If the problem persists, replace the drum cartridge.
<p>Printouts have irregularities</p> 	<ul style="list-style-type: none"> The paper you are using may have absorbed moisture, perhaps due either to high humidity or water having been spilled on the paper supply. Toner will not adhere well to wet paper. Replace the paper with dry paper.

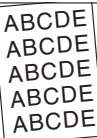
<p>Printouts have white and/or black lines</p> 	<ul style="list-style-type: none"> • The ADF glass or rollers of the ADF may be dirty. Clean the ADF glass and/or the rollers of the ADF. (See pages 14-2 to 14-4.) • The drum charge wire may be dirty. Open the front cover. To clean the drum charge wire, pull the blue rod toward you, making sure it fully extends. Then return the rod to its original position. (See page 14-4.) • The toner cartridge or drum cartridge may be defective. Remove the cartridges and check them for damage. If the problem persists, replace either or both of the cartridges as indicated.
<p>Printouts have toner smudges</p> 	<ul style="list-style-type: none"> • The document glass* is dirty. Wipe the document glass* with a dry soft cloth. • The document pad* is dirty Clean the document pad* with a soft cloth dampened and a mild detergent. • The drum charge wire may be dirty. Open the front cover. To clean the drum charge wire, pull the blue rod toward you, making sure it fully extends. Then return the rod to its original position. (See page 14-4.) • The toner cartridge or drum cartridge may be defective. Remove the cartridges and check them for damage. If the problem persists, replace either or both of the cartridges as indicated. • If you find smudges on the back of the printouts, the transport roller may be dirty. Your machine normally cleans the transport roller automatically. If other solutions fail, please contact your Muratec dealer.
<p>The image is not aligned properly on the paper.</p> 	<ul style="list-style-type: none"> • The document is not positioned correctly. Correctly adjust the document guides for the size of the document. • The ADF glass is dirty (while using the ADF). Wipe the ADF glass with a dry soft cloth. (See page 14-2.) • The document guides are not slid up against the edges of the document. Slide the document guides against the edges of the document. • Curled paper was loaded into the paper cassette. Flatten the paper before loading it.

* The document glass and the document pad is available for MFX-2030/MFX-1430 only.

If you cannot solve the problem

If you have a problem with your machine that you cannot solve with the information provided in this chapter, contact your local Muratec dealer or call the Muratec Customer Support Center at (800) 347-3296 (from U. S. only).

⚠ CAUTION: If you detect odd sounds, smoke or odor emitting from your machine, unplug it immediately and contact your local Muratec dealer. Do not attempt to disassemble or repair the machine yourself.

IMPORTANT: Attempting to repair the machine yourself may void the limited warranty.

When you contact the Muratec Customer Support Center, make sure you have the following information ready;

- Product name: F-560 or F-520 or MFX-2030 or MFX-1430
- Serial number (located on the label located at the back of the machine)
- Details of the problem
- Steps taken to try to resolve the problem and the results

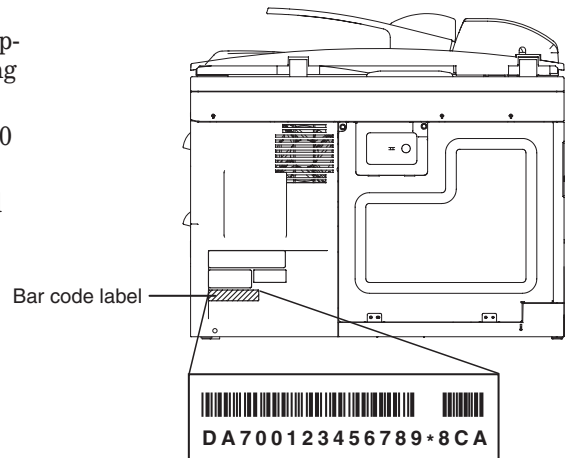

Close up, the bar code label looks something like this, but with a different set of numbers.

Chapter

AI

Appendix & Index

Specifications.....	AI-2
General.....	AI-2
Fax.....	AI-3
Copy.....	AI-3
Printer.....	AI-3
Scanner.....	AI-4
Consumable items.....	AI-4
Index.....	AI-5

Specifications

General

Multitasking	Quad Access
Scanning method	Flatbed CCD
Printing method	LED
Acceptable document size	(See page 2-10)
Document weight	(See page 2-10)
Printing paper size	(See page 2-12)
Power requirement	120 VAC 50/60 Hz.
Power consumption	Energy save mode: Approx. 15 W Standby: Approx. 50 Wh (MFX-1430/F-520) Approx. 63 Wh (MFX-2030/F-560) Maximum: Approx. 1040 W
Environmental temperature	10 to 32 °C
Relative humidity	20 to 80 %RH
Display (Liquid Crystal Display)	Touch panel display
Image memory capacity	7.8 MB (650 pages* approx.) plus optional 32 MB (additional 2,720 pages* approx.) *Using the ITU-T test document 1 with normal resolution.
Image memory backup time	7.8 MB: 72 hours* 39.8 MB: 24 hours* *Must be charged for at least 24 hours to reach full charge
Weight	MFX-2030: Approx. 48.7 lb. (22.1 kg) MFX-1430: Approx. 48.1 lb. (21.8 kg) F-560: Approx. 44.8 lb. (20.3 kg) F-520: Approx. 44.1 lb. (20.0 kg) (Without consumables and tray)
ADF capacity	Up to 80 sheets (Letter, 75 g/m ² or 20 lb. paper)
Paper cassette capacity	Paper cassette; 500 sheets (80 g/m ² or 20 lb. paper) Bypass tray; 50 sheets (80 g/m ² or 20 lb. paper)
Exit paper tray capacity	250 sheets (80 g/m ² or 20 lb. paper)
Dimensions (W×D×H)	20.5 × 19.3 × 17.6 in. (520 × 490 × 446 mm)

Fax

Compatibility	ITU-T Group 3 and Super Group 3
Applicable line	Public Switched Telephone Network (PSTN) or equivalent
Coding method	ITU-T-standard MMR, MR, MH and JBIG
Modem speed	33,600, 31,200, 28,800, 26,400, 24,000, 21,600, 19,200, 16,800, 14,400, 12,000, 9,600, 7,200, 4,800, 2,400 bps Automatic fallback
Address book	Up to 300 destinations can be stored
Call group	32 groups
Broadcasting	330 destinations
Transmission speed	Approx. 3 seconds/page.* * Based on memory-to-memory transmission of ITU-T test document 1 to a Muratec fax machine. Your transmission times will vary, but your machine always will provide the fastest transmission speeds possible under ITU-T guidelines and phone-line conditions.
Scanning width	8.2 in. (208 mm)
Grayscale	256-levels
Scanning resolution	Normal (8 dots/mm × 3.85 lines/mm) Fine (8 dots/mm × 7.7 lines/mm) Super-fine (16 dots/mm × 15.4 lines/mm) * * In the case that the remote fax has the ability of “16 dots/mm × 15.4 lines/mm”. Otherwise, the superfine resolution is “8 dots/mm × 15.4 lines/mm”. Grayscale (8 dots/mm × 7.7 lines/mm)

Copy

Scanning resolution	600 dpi × 300 lpi or 600 dpi. × 600 lpi.
Scanning width	8.5 in. (216 mm)
Print speed	MFX-2030/F-560: 20 ppm* MFX-1430/F-520: 14 ppm* * Using Letter-sized paper in 1st paper cassette.
Zoom ratio	Automatic document feeder: 25 to 100 % Document glass*: 25 to 400 %
Preset ratio	Automatic document feeder: 100 %, 78 %, 64 %, 50 % Document glass*: 154 %, 129 %, 121 %, 100 %, 78 %, 64 %, 50 % * The document glass is available for MFX-2030 and MFX-1430.

Printer

Print resolution	600 dpi
Print speed	MFX-2030/F-560: 20 ppm* MFGX-1430/F-520: 14 ppm* * Using Letter-sized paper in 1st paper cassette.
Color /Mono	Monochrome
Operating system	Windows 98, Me, NT 4.0, 2000, XP (English version) Windows server 2003 (English version)
Printer language	GDI (standard), PCL (option)
Interface	USB port Ethernet port

Scanner

Color/Mono	Color or Monochrome
Scanning resolution	Color: 600 dpi, 300 dpi, 200 dpi, 100 dpi Monochrome: 600 dpi, 300 dpi, 200 dpi
Scanning width	8.2 in. (208 mm)

Consumable items

MFX-2030/MFX-1430

Drum cartridge life Approx. 30,000 pages*

Toner cartridge life Approx. 16,000 pages*

Starter toner cartridge life Approx. 3,000 pages*

*Based on 6% document coverage and letter-sized two-page interval printing.

F-560/F-520

Drum cartridge life Approx. 20,000 pages*

Toner cartridge life Approx. 15,000 pages*

Starter toner cartridge life Approx. 4,000 pages*

*Based on 4% document coverage and letter-sized two-page interval printing.

NOTE: Specifications are subject to change without notice.

Index

A

- Activity journal 13-5
- Address book 2-2
 - deleting 2-10, 2-11
 - how to dial 2-12
 - registering/editing 2-4, 2-7, 2-8, 2-9
- Attachment 5-64
- Auto Reset Time 12-11

B

- Batch scanning 4-11, 5-59
- Batch transmission 3-35
- Block junk fax 3-46
- Broadcasting 3-24, 5-63

C

- Call group 2-14
 - deleting 2-15
 - how to dial 2-16
 - registering/editing 2-14
- Card Copy 7-25
- Character
 - entering 1-10
- Check mail 4-12
- Check message 14-23
- Cleaning
 - ADF rollers 14-3
 - drum charge wire 14-3
 - print head 14-3
 - scanning area 14-2
- Color 5-56
- Combine copy 7-14
- Control panel 1-3
- Copy print queue 3-18, 7-28
- Copy protection 11-22
- Copy reservation 7-7
- Copy settings 12-3
- Cover page 3-32

D

- Delayed transmission 3-34
- Department management 11-13
- Dial prefix 3-44
- Document handling 1-24
 - acceptable documents 1-24
- Document jams 14-9

- Document size 7-27
- Document type 5-4, 7-8
- Drum cartridge
 - replacing 14-7
- Duplex copy 7-16
- Duplex scanning 5-61

E

- e-mail subject 4-7, 5-24
- ECM mode 12-6
- Energy save mode 1-23, 12-12
- Erased document notification ... 13-10
- Errors
 - copying 14-28
 - faxing 14-26
 - local scanner 14-29
 - machine 14-26
 - PC printing 14-28
 - scanning 14-27
- Error codes 14-24
- Error messages 14-16

F

- F-code box feature 10-21
- Fax & Copy 3-28
- Fax forwarding 3-51
- Fax reception
 - print settings 3-20
- Fax reception mode 3-15
 - ans/fax ready mode 3-16
 - fax/tel ready mode 3-16
 - fax ready mode 3-16
 - tel/fax ready mode 3-16
 - tel ready mode 3-15
- Fax settings 12-4
- File format 4-13, 5-60
- File name 5-6

H

- Half-page reception 12-6

I

- Initial settings 1-16
 - broadcasting 1-18
 - date & time 1-17
 - daylight savings 1-18
 - default TTI 1-21
 - dial tone detection 1-20
 - fax reception mode 1-19
 - language 1-17

phone dialing type	1-19
time zone	1-22
TTI (your name)	1-20
your fax number	1-21

J

Journal report	
Sorting the job (Line up)	12-12
Journal reports	13-2

L

Lists	13-2
Loading documents	1-25
Loading paper	
into bypass tray	1-29
into paper cassettes	1-27
Location display	3-26

M

Macro keys	10-7
Mail history	4-4, 5-21
Mail settings	12-9
Maintenance	14-2
Management settings	12-11
Manual transmission	3-4
sending	3-9
Memory overflow message	3-4, 7-2
Memory transmission	3-3
sending	3-5, 3-6

N

Next document setting	7-3
-----------------------------	-----

O

Out-of-paper reception	3-18
Overseas transmission	3-43

P

Page counters	10-39
Paper handling	1-26
acceptable paper sizes	1-26
paper type setting	1-30
Paper jams	14-13
Paper settings	12-14
Paper size	7-11
Passcode protection	11-2
Phone call	2-19
call fails	2-20

how to dial	2-19
how to receive	2-20
optional handset volume	2-20
speaker volume	2-21
PIN masking	11-7
Polling reception	3-50
Polling transmission	3-42
Print quality problems	14-30
Program one-touch	10-14

Q

Quick memory transmission	3-3, 12-6
QWERTY keypad	1-10

R

Re-mail	4-3, 5-22
Real-time transmission	3-4
sending	3-8
Receive time stamp	12-6
Redialing	3-13
automatic	3-13
manual	3-13
Review commands	6-2
results of fax transaction	6-8

S

Scanner settings	12-7
Scanning contrast	3-3, 5-3, 7-9
Scanning resolution	3-2, 5-2
Scan size	3-41, 5-5
Scan to e-mail	5-9
search	5-15
selecting destination	5-11
sending	5-9
Scan to folder	5-28
folder shortcut	5-33
registering/editing folder shortcut .	5-35
Scan to FTP 5-42	
registering/editing FTP shortcut .	5-49
registering FTP shortcut	5-45
Security features	11-2
Security reception	11-3
Separate reception page	12-14
Separator page	3-57
Soft keys	10-2
Sorting	7-13
Sound settings	12-12
Stored document list	13-9

T

Toner cartridge	
replacing	14-5
Transmission confirmation report .	13-8
Troubleshooting	14-9
TTI	3-30

Z

Zoom	5-57, 7-12
------------	------------

